

2020 | EN
**DENTAL
CATALOG**

**ASA
DENTAL**

ASA DENTAL
MAKE PEOPLE SMILE

WELCOME TO ASA DENTAL PRODUCT CATALOGUE, OUR SELECTION OF INSTRUMENTS AND DISPOSABLE THAT CONTRIBUTED TO THE WRITING OF 50 YEARS OF HISTORY IN MODERN DENTISTRY.

INSPIRED BY A SIMPLE VISION, MAKING PEOPLE SMILE, WE STRIVE TO MANUFACTURE DENTAL INSTRUMENTS THAT HELP DENTAL PROFESSIONALS IMPROVE THE QUALITY OF LIFE OF MILLIONS OF PATIENTS, ANYWHERE IN THE WORLD.

INDEX

4 9	CORPORATE
10 13	SCIENTIFIC NAME INDEX
A1 A23	ASAONE DISPOSABLE PRODUCTS
B1 B25	DIAGNOSTIC
C1 C47	ORAL SURGERY
D1 D71	EXTRACTIVE SURGERY
E1 E41	IMPLANT SURGERY
F1 F51	RESTORATIVE
G1 G37	PERIODONTAL
H1 H37	ORTHODONTIC
I1 I19	INSTRUMENT CASSETTES AND TRAYS
J1 J43	IMPRESSION TRAYS
K1 K35	LABORATORY INSTRUMENTS
14 47	CODE INDEX
48 53	NAME INDEX

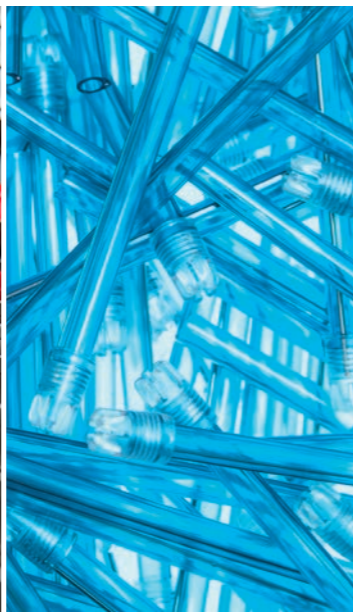

1961
FOUNDATION
The intuition of Aldo Puccetti becomes a company: Asa Dental is born

1975
MARLIA
Plant in Marlia starts production to satisfy increasing market demand

2004
KALTOPLAST
Asa Dental acquisition of Kaltoplast consolidates company's leading position as disposable saliva ejector manufacturer

2010
ASA DENTAL USA
International presence consolidates with Asa Dental USA subsidiary opening

2013
ASA DENTAL CHINA
Asa Dental China becomes operative, supporting one of the fastest growing markets

2015
BOZZANO
Smart warehouse in Italy powers logistics to minimize delivery time

2018
DUBAI
Asa Dental consolidates its presence in the Middle East with a new subsidiary in Dubai

1965
MANIAGO
Maniago production plants opens. Stainless steel instruments complement disposables offering

2001
DERBY DENTAL
Asa Dental acquires Derby Dental and extends product portfolio

2009
ALESSANDRO MALFATTI
A leadership turning point: Alessandro Malfatti becomes General Manager

2012
ASAONE
Investments to boost production efficiency for disposable products to increase quality, quantity and competitiveness

2014
MANIAGO
Maniago plants improves stainless steel instruments productivity and quality

2016
EDUCATIONAL CENTER
The new Educational Center connects leaders, Universities and dental professionals

2019
DIGITAL INTEGRATION
Digital technologies connect product design, development and communication

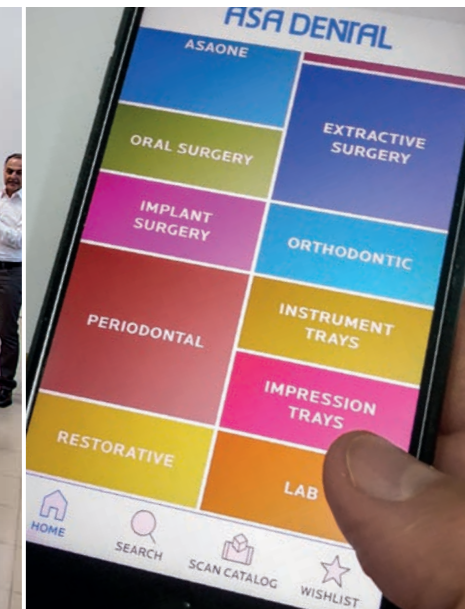
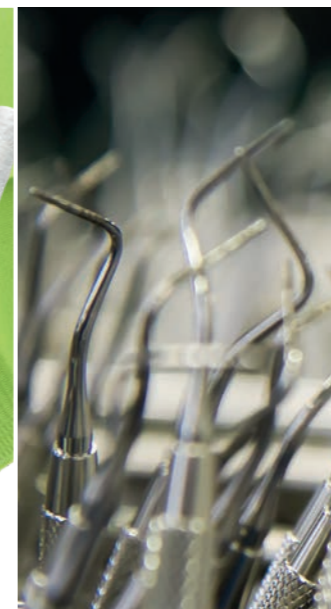

A GLOBAL PRESENCE

Making people smile, anywhere in the world, means being close to dental professionals, develop a deep understanding of the underlying differences of each market and tailor products and solutions to the exact needs of qualified professionals.

Through a structured international presence, with subsidiaries in USA, China and UAE, Asa Dental can operate at maximum efficiency at a global level, yet meet market requests at local level. Headquarters in Italy coordinates production, sales and logistics, managing an offer of innovative and traditional solutions powered by creative design and quality manufacturing, the contemporary interpretation of *made in Italy* spirit.

We proudly serve qualified dentists in more than 170 countries, helping them improve the quality of life of millions of patients and staying true to our mission by making effective dentistry accessible to everyone. Everywhere.

C. CHINA

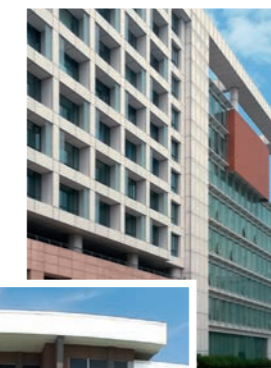

D. UAE



B. USA



A. ITALY

INNOVATION MEETS TRADITION

Production has become Asa Dental second nature from the very beginning.

Bucking a worldwide trend of decentralized production, we have decided to concentrate the entire manufacturing in Italy and guarantee our clients with the unmatched quality they deserve. The strict control over the whole production processes of disposable products and stainless steel instruments translates into a constant improvement of product quality and operational efficiency.

Each production plant focuses on its core competences, allowing employees to increase expertise and processes to be optimized. Regardless of the product, we can keep on responding to constantly shifting markets, whether in terms of quantity, quality or application.

With hundreds of thousands of products delivered every year, uncompromising quality testing and absolute traceability of products guarantee qualified dentists that every single product they use delivers all the necessary effectiveness, safety and comfort their patients demand.



SCIENTIFIC NAME INDEX

scientific name	instrument type	page
Adams	Wire forming pliers	H20
Aderer	Wire forming pliers	H21
Adson	Needle holders	C10
	Tissue pliers	C38, E36
Adson Brown	Tissue pliers	C41
Ainsworth	Punching forceps	F8
	Punching forceps - AsaLady	F9
Allen	Periosteals and Elevators	E23, G16
Angle	Wire forming pliers	H15, H19
Apexo	Root elevators	D54, D60
Arruga	Needle holders	C15
Backhaus	Towel clamps	C31
Ball	Filling instruments - Burnishers	F31
Barnhart	Curettes and Scalers	G5
Baumgartner	Needle holders	C11
Beale	Periosteals and Elevators	E22, G16
	Wax and modelling carvers	K16
Bein	Root elevators	D47, D48, D59
Beyer	Bone rongeurs	D44
Black	Cavity preparation instruments - margin trimmers	F18
	Cavity preparation instruments - hatchets	F19
Blumenthal	Bone rongeurs	D43, E30
Böhm	Crown pliers	F43, K29
Boley	Calipers	F42, K30
Bowman	Antrum probes	C37
Brewer	Clamp forceps	F9
Brünings	Tongue depressors	C34
Buchwald	Tongue depressors	C34
Buck	Gingivectomy knives	G24, G25
Buckley	Bone chisels and gouges	G27
Buser	Excisers	E22
	Membrane placement instruments	E31
Castroviejo	Needle holders	C6, C18, C19, E5, E6
Castroviejo-Barraquer	Needle holders	C19
Cattoni	Double ended Explorers	B8
Chompret	Syndesmotomes	D65
	Syndesmotomes - AsaLady	D65

scientific name	instrument type	page
Cleveland	Bone rongeurs	D42
Cleveland-Gardner	Bone rongeurs	D42
Cogswell	Root elevators	D54
Coleman	Root elevators	D46
Collin	Tongue forceps	C33
Columbia	Curettes and Scalers	G4
	Tongue depressors	C34
Cooley	Tissue pliers	C38
Coupland	Root elevators	D56, D58
Crane-Kaplan	Periodontal pocket markers	E35
	Curettes and Scalers	G8
	Gingivectomy knives	G25
	Periodontal pocket markers	G31
Crile	Hemostats	C20
Crile-Wood	Needle holders	C10, C11
Cryer	Extracting forceps - American pattern	D28, D32
	Root elevators	D55, D60
Curtis	Root elevators	D53
Darby-Perry	Excavators	F17
De La Rosa	Wire forming pliers	H18
De Marco	Curettes and Scalers	G5
Dean	Gum scissors	C7
Delphin	Wire forming pliers	H10
Derf	Needle holders	C13
Didner	Matrix retainers	F46
Eiselberg-Mathieu	Needle holders	C15
Fahnenstock	Wax knives	K22
Farabeuf	Retractors	C35
Felt	Felt composite instruments	F32
Fine Swedish	Needle holders	C14
Flagg	Cotton and dressing pliers	B4
	Cotton and dressing pliers - AsaLady	B5
Flohr	Root elevators	D49, D58, D59
Foc	Filling instruments	F30
Frahm	Amalgam carvers	F37
	Wax and modelling carvers	K13
Frazier	Surgical saliva ejectors	C44
Freer	Chisels	E16

scientific name	instrument type	page
	Periosteals and Elevators	E24, G17
Friedman	Root elevators	D57
	Bone rongeurs	D42
Furrer	Copper rings removing pliers	F43
Gardner	Bone chisels and gouges	G27
Gillies	Needle holders	C14
Goldman-Fox	Bone/soft tissue nippers	E29, D44
	Combination Explorers - Probes	B10
	Curettes and Scalers	G6
	Gingivectomy knives	G25
	Gum scissors	C3, C4, E4
	Periodontal pocket probes	G3
	Bone/soft tissue nippers	G30
	Periosteals and Elevators	E22
Goldman-Fox (Crane-Kaplan)	Periodontal pocket markers	B3, E35, G31
Goldman-Fox (special)	Gum scissors	C4
Goldman-Fox Williams	Combination Explorers - Probes	B11
Gracey	Gracey curettes	G11
	Gracey curettes - AF	G12
	Gracey curettes - MF	G13
Greenstein	Ceramic sculpturing instruments	K21
Gritman	Plaster knives	K23
	Wax and modelling carvers	K16
Gross-Maier	Dressing forceps	C32
Halsey	Needle holders	C13
Halsey-Smooth	Needle holders	C13
Halstead-Mosquito	Hemostats	C21
	Hemostats - AsaLady	C21
	Hemostats	F44
	Elastic forceps	H36
Harris	Extracting forceps - American pattern	D26
	Extracting forceps - American pattern, AsaLady	D30
Hartmann	Hemostats	C23
Hegar-Baumgartner	Needle holders	C11
Heidbrink	Root elevators	D54, D60
	Root-tip picks	D63, D64
Heidemann	Separating spatulas	F23, F24
	Separating spatulas - AsaLady	F24
Hemingway	Bone curettes	C45, E21, G20
Herbert	Mallets	G29
Hirschfeld	Files	G22

scientific name	instrument type	page
Hollenback	Amalgam carvers	F36
	Filling instruments - amalgam instruments	F28
	Wax and modelling carvers	K13
Hopkins	Periosteals and Elevators	E24, G17
How	Wire forming pliers	H23
Hourigan	Periosteals and Elevators	E23, G16
Hull	Extracting forceps - American pattern	D27
	Extracting forceps - American pattern, AsaLady	D31
Hylin	Root elevators	D45
	Wax and modelling carvers	K14
Hylin-Le Cron	Wax and modelling carvers	K14
Indiana University	Curettes and Scalers	G5
Iris	Gum scissors	C4, C5
Ivory	Punching forceps	F8
	Clamp forceps	F9
	Clamp forceps - AsaLady	F10
Iwanson	Calipers	F42, K30
Jacquette	Curettes and Scalers	G9
	Scalers	G15
Jameson	Calipers	K30
Jarabak	Wire forming pliers	H27
Johnson	Wire forming pliers	H20
Jones	Towel clamps	C31
Kelly	Gum scissors	C5, E4
	Hemostats	C23, F44
Kilner	Retractors	C35
Kirkland	Gingivectomy knives	G24
Klein	Extracting forceps for children	D39
Kocher	Hemostats	C20
	Retractors	C36
König	Periosteals and Elevators	E25, G18
Kopp	Root elevators	D50
La Grange	Gum scissors	C7
Ladmore	Filling instruments - Burnishers	F31
Langenbeck	Retractors	C36
Langer	Curettes and Scalers	G5
Lecluse	Root elevators	D63
Le Cron	Wax and modelling carvers	K15
Lessmann	Wax knives	K22
Lichtenberg	Needle holders	C15, E5
Locklin	Gum scissors	C6
London College	Cotton and dressing pliers	B4
	Cotton and dressing pliers - AsaLady	B5

scientific name	instrument type	page
London Hospital	Root elevators	D46
Lucas	Bone curettes	G20
Luer	Bone rongeurs	D42, E30
Luks	Root-canal Pluggers	B13
Luniatschek	Ligature instruments	H36
	Gauze packers	F39
Mac Millan	Root elevators	D56
Machtou	Root-canal Pluggers	B13
Markley	Filling instruments - amalgam	F29
Marquette	Filling instruments - amalgam	F28
Mathieu	Needle holders	C16, C17, E5
Mayo	Gum scissors	C8
Mayo-Hegar	Needle holders	C12
	Needle holders - AsaLady	C12
Mc Call	Curettes and Scalers	G7
Mc Kellops	Wire forming pliers	H18
Mead	Extracting forceps	D24
	Bone rongeurs	D43
	Mallets	E16, G29
	Periosteals and Elevators	E24, G17
Meriam	Cotton and dressing pliers	B4
	Cotton and dressing pliers - AsaLady	B5
	Tweezers	K19
Merrit	Periodontal pocket Probes	G3
Mershon	Band pushers	H34
Metzenbaum	Gum scissors	C8
Metzenbaum-Delikat	Gum scissors	C8, E4
Micro-Adson	Tissue pliers	C38, C39
Micro-Barraquer	Needle holders	C17, E6
Micro-Mosquito	Hemostats	C22, F44
Middeldorpf	Retractors	C37, E12
Miller	Files	E21, G23
	Articulating paper forceps	F42
Miller-Apexo	Root elevators	D52, D60
Mini-Crane-Kaplan	Curettes and Scalers	G8
Mini-Friedman	Bone rongeurs	D42, E30
	Bone rongeurs	G30
	Root elevators	D57
Mini-Ruskin	Bone rongeurs	D44
Mini Ryder	Needle holders	C13
Molt	Mouth gags	C33
	Periosteals and Elevators	E23, G16
Nabers	Double ended Explorers	B11
Nance	Wire forming pliers	H11, H12, H15

scientific name	instrument type	page
Neumann	Gum scissors	C7
Nevius	Extracting forceps - American pattern	D27
	Extracting forceps - American pattern, AsaLady	D31
New York University	Filling instruments - Burnishers	F31
Novatech	Periodontal pocket Probes	G3
Noyes (Castroviejo)	Gum scissors	C7
Ochsenbein	Bone chisels and gouges	G27
	Chisels	G26
Ogden-Felsch	Extracting forceps	D19
Olsen-Hegar	Needle holders	C10
Orban	Medication instruments	F39
	Gingivectomy knives	G25
Orringer	Retractors - lip	E11
	Retractors - Tongue depressors	C34
Partsch	Bone chisels and gouges	G28
	Mallets	E16, G29
	Periosteals and Elevators	E24, G17
Pean	Hemostats	C20
Perry	Cotton and dressing pliers	B4
Physick	Extracting forceps - American pattern	D25
	Extracting forceps - American pattern, AsaLady	D29
P.K. Thomas	Wax and modelling carvers	K17
Polokoff	Files	G23
Pott	Root elevators	D63
Prichard	Periosteals and Elevators	E23, G16
Quinby	Gum scissors	C5
Reynolds	Wire forming pliers	H16
Rhein	Single ended Explorers	B6
Rhodes	Chisels	G26
Roach	Wax and modelling carvers	K16
Roser-Koenig	Mouth gags	C33
Routurier	Extracting forceps	D6, D7, D16
Rule	Curettes and Scalers	G5
Sanders	Gingivectomy knives	G25
Schaedle	Towel clamps	C31
Schilder	Root-canal Pluggers	B14
Schluger	Files	G22
Schmeckebier-Apexo	Root elevators	D49, D59
Schwarz	Wire forming pliers	H25
Seldin	Root elevators	D52, D53, D54, D60
	Periosteals and Elevators	E25, G18
Semken-Taylor	Tissue pliers	C41, E36

scientific name	instrument type	page
Senn-Miller	Retractors	C35
Schaedle	Towel clamps	C31
Spencer	Gum scissors	C8
SS. White	Excavators	F16
Sternberg	Retractors	E11
	Tongue depressors	C34
Stevens	Gum scissors	C9
Stieglitz	Forceps for silver cones	B16
	Extracting forceps for root splinters	D41
Stoke	Clamp forceps	F9
Stout	Root elevators	D53
Sugarman	Files	G22
Sullivan	Gum scissors	C6
Tanner	Filling instruments - amalgam	F28
Taylor	Curettes and Scalers	G8
Toennis	Needle holders	C14
Tofflemire	Matrix retainers	F46
	Matrix	F47
Tomati	Gum guillotine forceps	G30
Tomes	Extracting forceps - American pattern	D27
	Extracting forceps - American pattern, AsaLady	D31
Towner	Scalers	G14
Towner	Scalers	G14
Jacquette		
Townley	Calipers	K30
Trotter	Extracting forceps	D17, D19, D20
Tweed	Wire forming pliers	H12, H13, H14, H15
University of Michigan	Combination Explorers - Probes	B10
	Periodontal pocket Probes	G3
University of Minnesota	Retractors	E12
	Tongue depressors	C34
USC Towner (University of South California)	Amalgam carvers	F37
	Gingivectomy knives	G25
	Wax and modelling carvers	K13
Vickers	Mallets	G29
Vehe	Wax and modelling carvers	K16
Wahl	Files	G23
Wakefield	Bone chisels and gouges	G27
Walter F. Barry	Root elevators	D61
Waldsachs	Wire forming pliers	H11
Ward	Filling instruments - amalgam	F28

scientific name	instrument type	page
	Amalgam carvers	F36
	Wax and modelling carvers	K13
Warwick-James	Root-tip picks	D64
Wedelstaet	Cavity preparation instruments - chisels	F18
Weingart	Utility pliers	H29
Westcott	Filling instruments - amalgam	F25
	Filling instruments - Burnishers	F31
	Gum scissors	C7
White	Extracting forceps	D17
Wiland	Amalgam carvers	F37
Williams	Combination Explorers - Probes	B10, B11
	Periodontal pocket Probes	G3
Williger	Bone curettes	G21
	Periosteals and Elevators	E25, G19
	Retractors	C35
Winter	Root elevators	D62
Witzel	Extracting forceps for roots	D40
Woodson	Filling instruments - plastic	F35
Woodward	Root elevators	D56
Young	Tongue forceps	C33
	Wire forming pliers	H14
Younger-Good	Curettes and Scalers	G8
Zahle	Wax and modelling carvers	K15, K16
Zerfing-Chisel	Curettes and Scalers	G4



ASAONE DISPOSABLES

MADE IN ITALY

DENTISTS' FIRST CHOICE FOR DISPOSABLE PROFESSIONAL PRODUCTS

Asa Dental applied to an entire product family the same design and production efficiency that made its saliva ejectors the world best seller in the category. The result is AsaOne, the disposable product line designed for protection and comfort of dental professionals and their patients. Safe materials and innovative design meet color and shape to turn every dental practice into a welcoming place where best results are achieved.



- A2 Saliva ejectors
- A6 Napkins
- A8 Dappen dishes
- A10 Plastic trays
- A12 Cotton rolls
- A13 Sterilization rolls
- A14 Face masks
- A15 Examination gloves
- A18 Sterilization pouches
- A19 Bibs
- A20 Accessories

Mint-scented saliva ejectors - AsaFresh



Soft-tip saliva ejectors - Total-Comfort



REMOVABLE TIP
100 pcs / polybag
10 polybags / carton
1000 pcs

2908E-AT13/15
blue tube
transparent tip
2908E-TT13/T15
transparent tube
transparent tip
2908E-VT13/15
green tube
transparent tip



150 mm
2908E-AT15
130 mm
2908E-AT13



150 mm
2908E-TT15
130 mm
2908E-TT13



150 mm
2908E-VT15
130 mm
2908E-VT13

REMOVABLE TIP
100 pcs / polybag
10 polybags / carton
1000 pcs

2903E-BA155
white tube
blue tip
2903E-BT155
white tube
transparent tip
2903E-TA155
transparent tube
blue tip
2903E-TT155
transparent tube
transparent tip



155 mm
2903E-BA155



155 mm
2903E-BT155



155 mm
2903E-TA155



155 mm
2903E-TT155

BONDED TIP
100 pcs / polybag
10 polybags / carton
1000 pcs

2908E-BBS15
white tube
white tip
2908E-TCS15
transparent tube
light-blue tip
2908E-TTS15
transparent tube
transparent tip
2908E-VTS15
green tube
transparent tip



150 mm
2908E-BBS15



150 mm
2908E-TCS15



150 mm
2908E-TTS15



150 mm
2908E-VTS15

BONDED TIP
100 pcs / polybag
10 polybags / carton
1000 pcs

2903E-BAS155
white tube
blue tip
2903E-BTS155
white tube
transparent tip
2903E-TAS155
transparent tube
blue tip
2903E-TTS155
transparent tube
transparent tip



155 mm
2903E-BAS155



155 mm
2903E-BTS155



155 mm
2903E-TAS155



155 mm
2903E-TTS155

Multi-color saliva ejectors

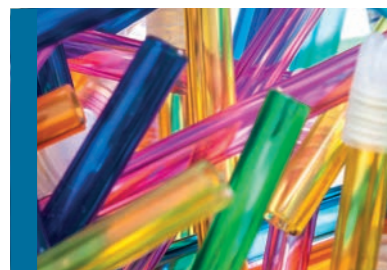

Multi-color saliva ejectors



REMOVABLE TIP
2900E
100 pcs / polybag
10 polybags / carton
1000 pcs

2900E-AT13/15
blue tube
transparent tip
2900E-TT13/15
transparent tube
transparent tip
2900E-VT13/15
green tube
transparent tip
2900E-BT13/15
white tube
transparent tip
2900E-GT13/15
yellow tube
transparent tip
2900E-LT13/15
lilac tube
transparent tip

REMOVABLE TIP
2901E
250 pcs / polybag
20 polybags / carton
5000 pcs

2901E-AT13/15
blue tube
transparent tip
2901E-TT13/T15
transparent tube
transparent tip
2901E-VT13/15
green tube
transparent tip



150 mm
2900E-AT15
2901E-AT15
130 mm
2900E-AT13
2901E-AT13



150 mm
2900E-TT15
2901E-TT15
130 mm
2900E-TT13
2901E-TT13



150 mm
2900E-VT15
2901E-VT15
130 mm
2900E-VT13
2901E-VT13



150 mm
2900E-BT15
130 mm
2900E-BT13



150 mm
2900E-GT15
130 mm
2900E-GT13



150 mm
2900E-LT15
130 mm
2900E-LT13

REMOVABLE TIP
100 pcs / polybag
10 polybags / carton
1000 pcs

2900E-OT13/15
orange tube
transparent tip
2900E-RT13/15
red tube
transparent tip
2900E-ZT13/15
cyan tube
transparent tip



150 mm
2900E-OT15
130 mm
2900E-OT13



150 mm
2900E-RT15
130 mm
2900E-RT13



150 mm
2900E-ZT15
130 mm
2900E-ZT13

BONDED TIP
100 pcs / polybag
10 polybags / carton
1000 pcs

2900E-ATS15
blue tube
transparent tip
2900E-BBS15
white tube
white tip
2900E-TCS15
transparent tube
light-blue tip
2900E-TTS15
transparent tube
transparent tip
2900E-VTS15
green tube
transparent tip



150 mm
2900E-ATS15



150 mm
2900E-BBS15

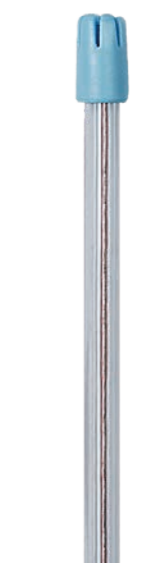

150 mm
2900E-TCS15



150 mm
2900E-TTS15



150 mm
2900E-VTS15

Napkins - AsaRainbow



Napkins - AsaRainbow



Lilac
3510-L
3511-L



Lime
3510-LI
3511-LI

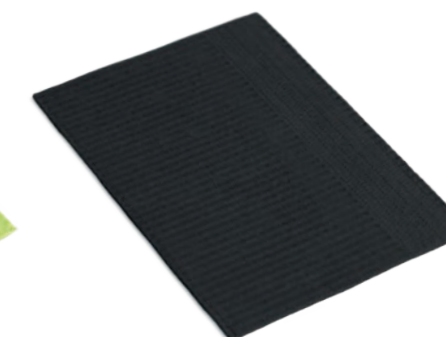

Black
3510-N
3511-N

33x45 cm
three-ply paper

3510
carton of 500 pcs

3511
available on request
50 pcs / pack
10 packs / carton
500 pcs



White
3510-B
3511-B

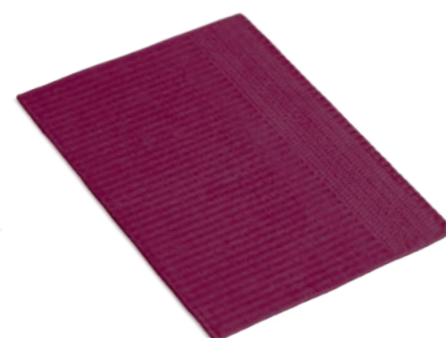

Burgundy
3510-BX
3511-BX



Orange
3510-O
3511-O



Pink
3510-P
3511-P



Peach
3510-PE
3511-PE

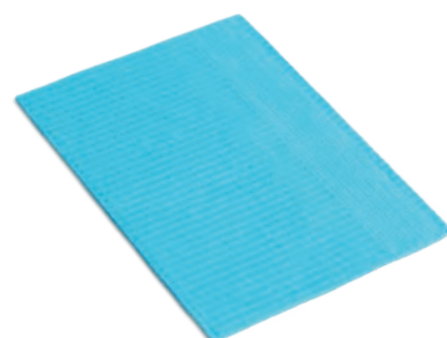

Light blue
3510-C
3511-C

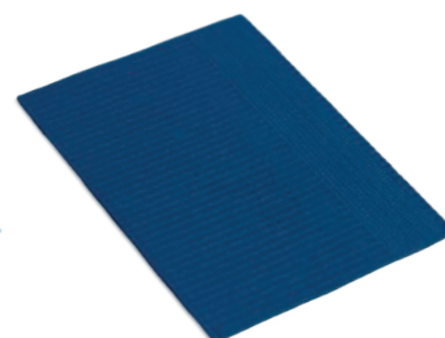

Dark blue
3510-D
3511-D



Yellow
3510-G
3511-G



Green
3510-V
3511-V



3200
patient bib chain

Dappen dishes



Dappen dishes

50 pcs / pack
20 packs / carton
1000 pcs



Black
3700-N



Yellow
3700-G

50 pcs / pack
5 packs per color / carton
1000 pcs



Yellow + Red + White + Blue
3700-MX



Blue
3700-C



White
3700-B



Red
3700-R

Plastic trays

281x183x17 mm



White smooth
AL2727-1



White knurled
AL2727-1Z

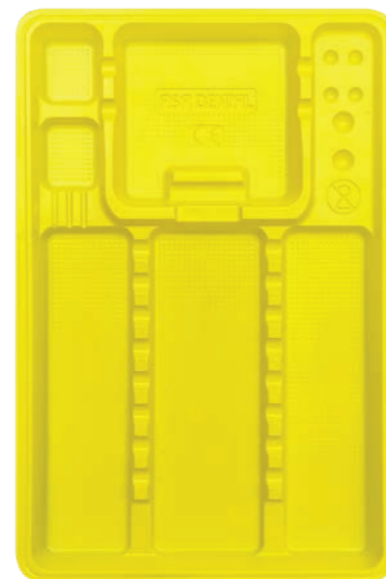

Yellow knurled
AL2727-1GZ



Blue knurled
AL2727-1AZ



Teal-green knurled
AL2727-1CZ

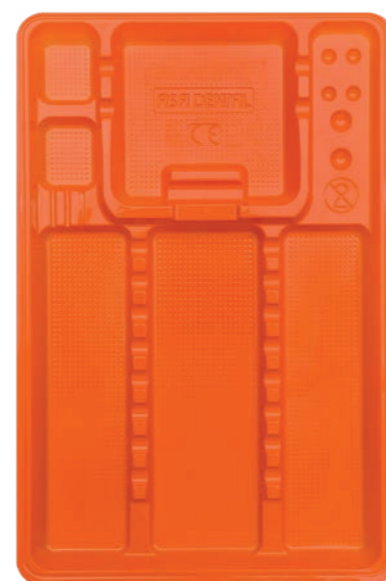

Orange knurled
AL2727-1OZ

Plastic trays

183x140x17 mm



White smooth
AL2727-2

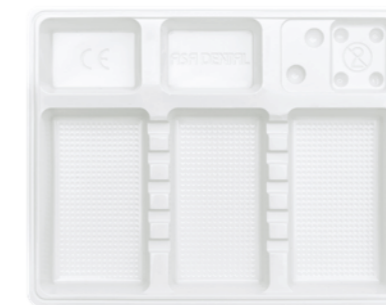

White knurled
AL2727-2Z



Yellow knurled
AL2727-2GZ



Blue knurled
AL2727-2AZ

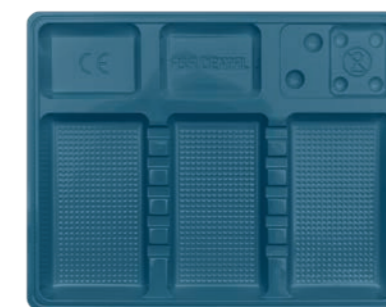

Teal-green knurled
AL2727-2CZ



Orange knurled
AL2727-2OZ

200x150 mm
400 pcs / box



White smooth
AL2738-1

White smooth
AL2738-2

200x100 mm
400 pcs / box

Cotton rolls

100% cotton
300 gr. / polybag
20 polybags / carton

16800 pcs / carton

Ø 8 mm | 840 pcs
3520-1



12000 pcs / carton

Ø 10 mm | 600 pcs
3520-2



9000 pcs / carton

Ø 12 mm | 450 pcs
3520-3

**Sterilization rolls**

one ply of paper and one ply of polypropylene
with sterilization process indicator

8 pcs / carton

50 mm x 200 mt
3400E-55

75 mm x 200 mt
3400E-75

4 pcs / carton

100 mm x 200 mt
3400E-100

150 mm x 200 mt
3400E-150

2 pcs / carton

200 mm x 200 mt
3400E-200

250 mm x 200 mt
3400E-250

1 pc / carton

300 mm x 200 mt
3400-300



Surgical face masks

high quality materials
nonwoven
hypoallergenic
without fibreglass
level of B.F.E. 99.7%
50 pcs / box
6 boxes / carton
300 pcs

earloop face masks

White

3450E-B

Light blue

3450E-C

Pink

3450E-R

Green

3450E-V



Happy Kid
earloop face masks

Blue

3450E-HC

Pink

3450E-HR

**Examination gloves**

latex
ambidextrous
non-sterile
100 gloves / box
10 boxes / carton
1000 pcs

powder- and cornstarch-free
hypoallergenic

Extra small (5-6)

3301E-XS

Small (6-7)

3301E-S

Medium (7-8)

3301E-M

Large (8-9)

3301E-L



low powder

Extra small (5-6)

3303E-XS

Small (6-7)

3303E-S

Medium (7-8)

3303E-M

Large (8-9)

3303E-L



knurled
with powder
green

Extra small (5-6)

3305-XS

Small (6-7)

3305-S

Medium (7-8)

3305-M

Large (8-9)

3305-L



Examination gloves

nitrile
 powder and latex free
 finger-textured
 ambidextrous
 non-sterile
 240 mm
 AQL 1.5
 100 gloves / box
 10 boxes / carton
 1000 pcs

Blue

Extra small (5-6)
 3309E-XS

Small (6-7)
 3309E-S

Medium (7-8)
 3309E-M

Large (8-9)
 3309E-L



White

Extra small (5-6)
 3310E-XS

Small (6-7)
 3310E-S

Medium (7-8)
 3310E-M

Large (8-9)
 3310E-L



Examination gloves

Cornflower blue

Extra small (5-6)
 3313E-XS

Small (6-7)
 3313E-S

Medium (7-8)
 3313E-M

Large (8-9)
 3313E-L



Light purple

Extra small (5-6)
 3314E-XS

Small (6-7)
 3314E-S

Medium (7-8)
 3314E-M

Large (8-9)
 3314E-L



Green

Extra small (5-6)
 3311E-XS

Small (6-7)
 3311E-S

Medium (7-8)
 3311E-M

Large (8-9)
 3311E-L



Teal blue

Extra small (5-6)
 3312E-XS

Small (6-7)
 3312E-S

Medium (7-8)
 3312E-M

Large (8-9)
 3312E-L



Pink

Extra small (5-6)
 3315E-XS

Small (6-7)
 3315E-S

Medium (7-8)
 3315E-M

Large (8-9)
 3315E-L



Black

Extra small (5-6)
 3316E-XS

Small (6-7)
 3316E-S

Medium (7-8)
 3316E-M

Large (8-9)
 3316E-L



Sterilization pouches

self-sealing pouches

200 pcs / box
12 boxes / carton
2400 pcs



75x250 mm
3403-75



90x230 mm
3403-90

200 pcs / box
8 boxes / carton
1600 pcs



140x250 mm
3403-140

Bibs

tear off rolls
waterproof
two-ply polyethylene and paper

3251E
53x60 cm
80 bibs
9-roll / carton

3252E
53x80 cm
60 bibs
9-roll / carton



White
3251E-B/9
3252E-B/9



Light blue
3251E-C/9
3252E-C/9



Dark blue
3251E-D/9
3252E-D/9



Yellow
3251E-G/9
3252E-G/9



Lilac
3251E-L/9
3252E-L/9



Lime
3251E-LI/9
3252E-LI/9



Orange
3251E-O/9
3252E-O/9



Green
3251E-V/9
3252E-V/9

Cups



200 cc
100 pcs / bag
30 bags / carton
3000 pcs



White
3818-B

Plastic mixing spatulas

100 pcs / package



AL2736

Mixing trays

70x54x6 mm
12 wells each
1000 pcs / package



AL2735

Drinking cup dispensers

85 x 85 x 360 mm
up to a maximum of 70 cups



Silver
2750-1



White
2750-2

Plastic syringes

for elastomers
50 pcs / box
10 boxes / carton
500 pcs



3710

Used needle holder

plastic box



AL2766

First examination instruments kit

non-sterile
content:
2100-M
0700-M
0601-M



S0600-M

Waste container

1000 pcs / box



AL2767-1

aluminium base
for waste containers



AL2767-2

Synthetic instant ice

14x18 cm
non woven bag
temperature -4°C
25 bags / carton



3600E

Disposable plastic impression trays

24 pcs / pack



12 lower + 12 upper



1
2853E-1

2
2853E-2



3
2853E-3

4
2853E-4

12 partial right + 12 partial left



1
2853E-1DS

2
2853E-2DS

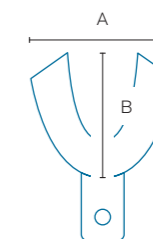

LOWER	A (mm)	B (mm)
1	61	50
2	67	52
3	72	56
4	74	58

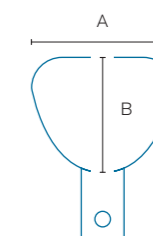

UPPER	A (mm)	B (mm)
1	61	49
2	65	53
3	70	59
4	73	63



DIAGNOSTIC

MADE IN ITALY

EMPOWERING DENTISTS TO MAKE PRECISE AND ACTIONABLE DIAGNOSIS

The ultimate goal of dental care is to assist in the lifelong maintenance of a dentition that is functional, comfortable and aesthetically pleasant. It all starts with a reliable diagnosis that can be clearly and effectively communicated to the patient. For this reason, we designed our diagnostic instruments selecting those materials offering the ideal trade-offs between precision, elasticity, ergonomics and durability, with different emphasis depending on the scope of the tool.

- B3 Pocket markers
- B3 Cotton and dressing pliers
- B5 Explorers
- B10 Combination Explorers - Probes
- B12 Spreaders
- B13 Pluggers
- B15 Vertical condensers
- B15 Excavators
- B16 Endodontic instruments
- B17 Mirrors
- B21 Ultralight Retractor
- B22 Kits

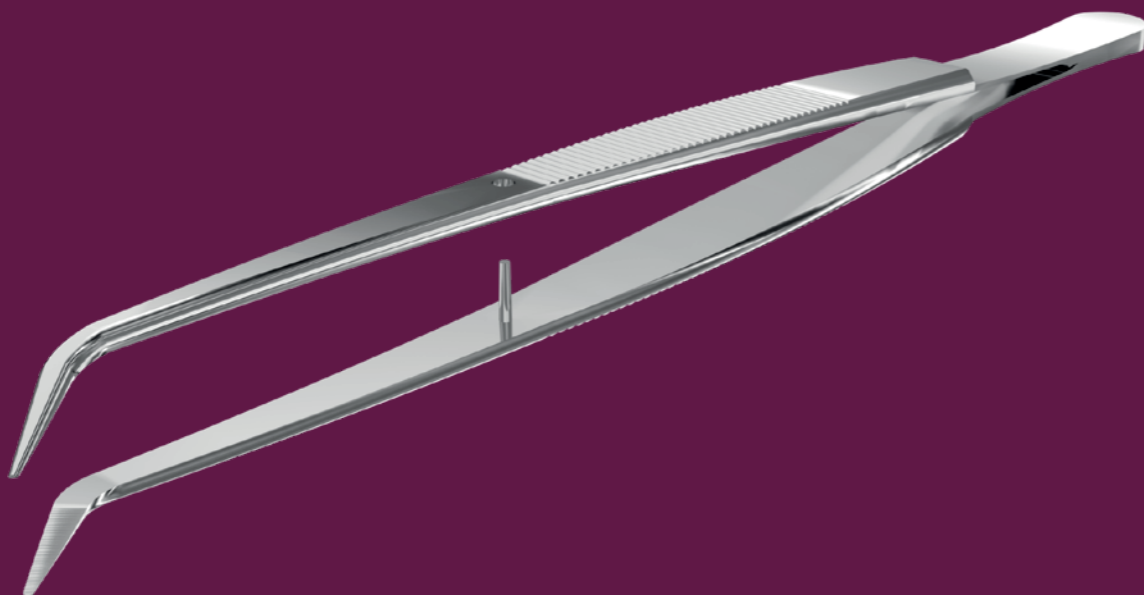

Handle options

SINGLE END

Asa60
(stainless steel)
ø 6.0 mm



Asa60M
(stainless steel, single-piece)
ø 6.0 mm



Leonardo ML
(stainless steel)
ø 7.0 mm



● Alu80
(aluminum, hollow)
ø 8.0 mm



● Magic Color MC
(aluminum core and non-slip plastic)
ø 8.0 / 10.5 mm



DOUBLE END

Asa60
(stainless steel)
ø 6.0 mm



Asa Light MV
(stainless steel, hollow)
ø 8.0 mm



Leonardo ML
(stainless steel)
ø 7.0 mm



● Magic Color MC
(aluminum core and non-slip plastic)
ø 8.0 / 10.5 mm



How to use

- 3R Rhein → pattern + scientific name
- 0700-3R → Asa Dental code
- Asa60 → handle option

AsaLady

- products ergonomically designed for women hands:
- smaller and lighter handles
 - smaller finger holes
 - reduced size
 - code starts with "W" or "SW"

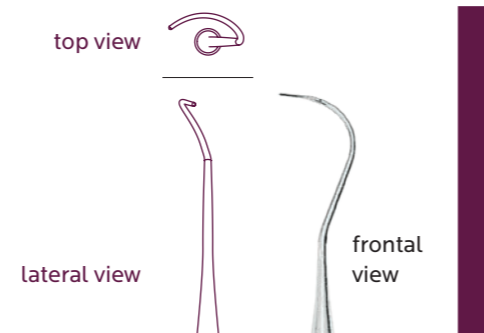
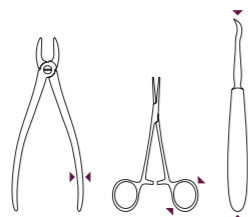

Periodontal pocket markers



1 (Crane-Kaplan) Goldman-Fox
15 cm
0650-1

2 (Crane-Kaplan) Goldman-Fox
15 cm
0650-2

Cotton and dressing pliers self-locking



18L Locking
16 cm
0600-18L

1
15 cm
0602-1

2
15 cm
0602-2

Cotton and dressing pliers

set of 5



1 Flag
S0601-1



2 London-College
S0601-2



3 Meriam
S0601-3

Cotton and dressing pliers



0600-2
Antimagnetic and easy to clean, these pliers are comfortably light and efficiently durable. Shape and angles make them ideal for any situations, even the most complicated. Thanks to an anti-adherent coating, they can be used to place temporary filling materials.



1 Flag 15 cm 0601-1	2 London-College 15 cm 0601-2	3 Meriam 16 cm 0601-3	4 Perry 13 cm 0601-4	5 Perry 13 cm 0601-5	4 Perry 13 cm 0600-4	2 London-College 16 cm 0600-2	3 16 cm 0600-3	17 16 cm 0600-17	18 16 cm 0600-18	19 16.5 cm 0600-19	1 Flag 14 cm W0610-1	2 London College 14 cm W0610-2	3 Meriam 15 cm W0610-3
---------------------------	-------------------------------------	-----------------------------	----------------------------	----------------------------	----------------------------	-------------------------------------	----------------------	------------------------	------------------------	--------------------------	----------------------------	--------------------------------------	------------------------------

Single ended Explorers



2
0700-2
Asa60
0701-2
Asa60M



3
0700-3
Asa60
0701-3
Asa60M



3A
0700-3A
Asa60
0701-3A
Asa60M



3R Rhein
0700-3R
Asa60
ML0700-3R
Leonardo ML



5
0700-5
Asa60
0701-5
Asa60M



6
0700-6
Asa60
0701-6
Asa60M
ML0700-6
Leonardo ML
MC0700-6
● Magic Color MC



8
0700-8
Asa60
0701-8
Asa60M
ML0700-8
Leonardo ML



9
0700-9
Asa60
0701-9
Asa60M
ML0700-9
Leonardo ML
MC0700-9
● Magic Color MC



10
0700-10
Asa60
0701-10
Asa60M



11
0700-11
Asa60
0701-11
Asa60M



12
0700-12
Asa60
0701-12
Asa60M



16
0700-16
Asa60
0701-16
Asa60M



17
0700-17
Asa60
0701-17
Asa60M
ML0700-17
Leonardo ML



17A
0700-17A
Asa60
0701-17A
Asa60M



23
0700-23
Asa60
0701-23
Asa60M
ML0700-23
Leonardo ML
MC0700-23
● Magic Color MC

Single ended Explorers



0700-23
Designed for outstanding ergonomics, they are perfect for cavity diagnostic. The ideal trade-off between sharpness and flexibility ensures investigation of minimal filling fissures and excess, as well as confirmation of optimal occlusion when fixed dental prosthetics demand for uncompromised precision.

set of 5
Asa60



6
S0700-6



9
S0700-9



11
S0700-11



16
S0700-16



23
S0700-23

Double ended Explorers



6/9
0704-6D9
Asa60
ML0704-6D9
Leonardo ML
MC0704-6D9
● Magic Color MC

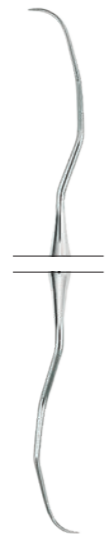

11/12AF
0704-11/12AF
Asa60
ML0704-11/12AF
Leonardo ML
MC0704-11/12AF
● Magic Color MC

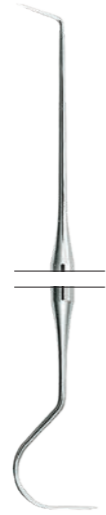

16/23
0704-16D1
Asa60
MV0704-16D1
Asa Light MV



16/3
0704-16D2
Asa60
MV0704-16D2
Asa Light MV

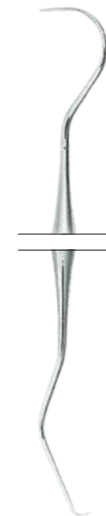

23/17
0704-23D1
Asa60
MV0704-23D1
Asa Light MV
ML0704-23D1
Leonardo ML
MC0704-23D1
● Magic Color MC

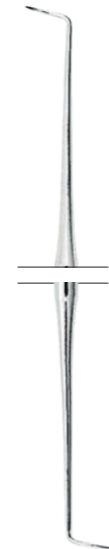

3
0709-3
Asa60
MV0709-3
Asa Light MV

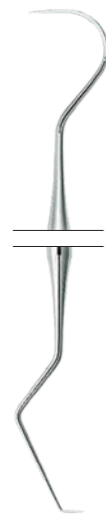

23/17A
0704-23D2
Asa60
MV0704-23D2
Asa Light MV

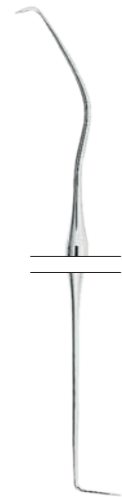

UT 1/2 Cattoni
0704-UT1
Asa60
MV0704-UT1
Asa Light MV

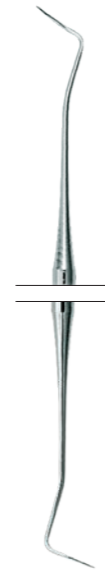

2
0709-2
Asa60
MV0709-2
Asa Light MV

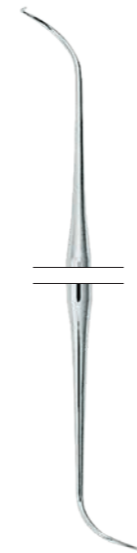

2A
0709-2A
Asa60
MV0709-2A
Asa Light MV

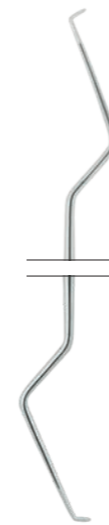

17/19
ML0704-6D2
Leonardo ML

Double ended Explorers

Root-canal Explorers



6/1
0710-6D1
Asa60
MV0710-6D1
Asa Light MV

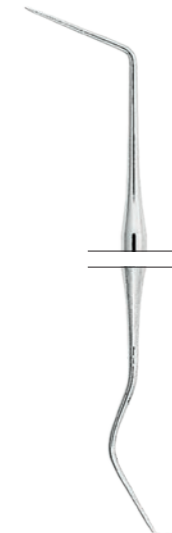



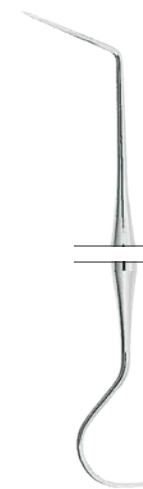

6/17
0710-6D2
Asa60
MV0710-6D2
Asa Light MV

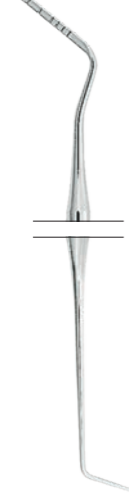
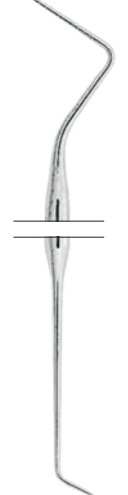
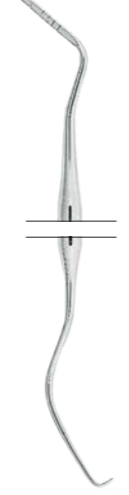

6/23
0710-6D3
Asa60
MV0710-6D3
Asa Light MV

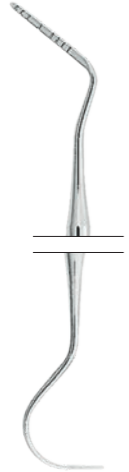
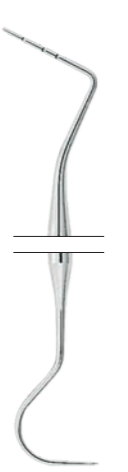
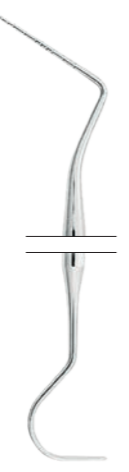
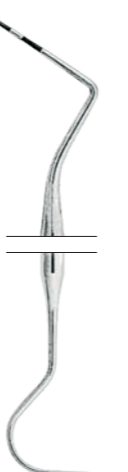
Combination Explorers - Probes

1 2 3 5 7 8 9 10 FLAT TIP	1 2 3 5 7 8 9 10 FLAT TIP	1 2 3 5 7 8 9 10	1 2 3 5 7 8 9 10 FLAT TIP	3 6 8	1 2 3 5 7 8 9 10
					
3 Goldman-Fox 0705L-3GF Asa60 MV0705-3GF Asa Light MV	16 Goldman-Fox 0705L-16GF Asa60 MV0705-16GF Asa Light MV	16 Williams 0705L-16W Asa60 MV0705-16W Asa Light MV	17 Goldman-Fox 0705L-17GF Asa60 MV0705-17GF Asa Light MV	17 University of Michigan 0705L-17UM Asa60 MV0705-17UM Asa Light MV	17 Williams 0705L-17W Asa60 MV0705-17W Asa Light MV
1 2 3 5 7 8 9 10 FLAT TIP	3 6 8	1 2 3 5 7 8 9 10 12 14	3 6 8 11	3 6 9 12	
					
23 Goldman-Fox 0705L-23GF Asa60 MV0705-23GF Asa Light MV	23 University of Michigan 0705L-23UM Asa60 MV0705-23UM Asa Light MV	23 Williams 0705L-23W Asa60 MV0705-23W Asa Light MV ML0705-23W Leonardo ML	23/CP11 0706L-2311 Asa60 MV0706-2311 Asa Light MV	23/CP12 0706L-2312 Asa60 MV0706-2312 Asa Light MV	

Double ended Explorers

1 2 3 5 7 8 9 10 FLAT TIP	3 6 9 12		
			
1 2 3 5 7 8 9 10	12 9 6 3		
Goldman-Fox Williams 0707L-GFW Asa60 MV0707-GFW Asa Light MV MC0707-GFW ● Magic Color MC	2N Nabers 0708L-2N Asa60	1N Nabers 0708-1N Asa60 MV0708-1N Asa Light MV	2N Nabers 0708-2N Asa60 MV0708-2N Asa Light MV ML0708-2N Leonardo ML MC0708-2N ● Magic Color MC

MV0707L-GFW



Root-canal Spreaders



0800-1
ROOT CANAL INSTRUMENTS
A special coating help tips work without any adherence issue in any condition, including those asking for extra pressure.

1
0800-1
Asa60
ML0800-1
Leonardo ML
MC0800-1
● Magic Color MC

2
0800-2
Asa60
ML0800-2
Leonardo ML
MC0800-2
● Magic Color MC

3
0800-3
Asa60
ML0800-3
Leonardo ML
MC0800-3
● Magic Color MC

4
0800-4
Asa60

5
0800-5
Asa60

6
0800-6
Asa60

7
0800-7
Asa60

Root-canal Pluggers

1 Luks
0801-1
Asa60

2 Luks
0801-2
Asa60

3 Luks
0801-3
Asa60

4 Luks
0801-4
Asa60











1 Machtou
ML0803-1
Leonardo ML
MC0803-1
● Magic Color MC

2 Machtou
ML0803-2
Leonardo ML
MC0803-2
● Magic Color MC



3 Machtou
ML0803-3
Leonardo ML
MC0803-3
● Magic Color MC

4 Machtou
ML0803-4
Leonardo ML
MC0803-4
● Magic Color MC

Root-canal Pluggers

<p>Ø 0.30 15 20</p>  <p>FSR DENTIL ML0802-1 © Italy</p> <p>7 ½ Schilder ML0802-1 Leonardo ML</p>	<p>Ø 0.35 10 15 20</p>  <p>8 Schilder ML0802-2 Leonardo ML MC0802-2 ● Magic Color MC</p>	<p>Ø 0.40 5 10 15 20</p>  <p>8 ½ Schilder ML0802-3 Leonardo ML</p>	<p>Ø 0.50 5 10 15 20</p>  <p>9 Schilder ML0802-4 Leonardo ML MC0802-4 ● Magic Color MC</p>	<p>Ø 0.60 5 10 15 20</p>  <p>9 ½ Schilder ML0802-5 Leonardo ML</p>	<p>Ø 0.70 5 10 15 20</p>  <p>10 Schilder ML0802-6 Leonardo ML MC0802-6 ● Magic Color MC</p>
<p>Ø 0.80 5 10 15 20</p>  <p>10 ½ Schilder ML0802-7 Leonardo ML</p>	<p>Ø 0.90 5 10 15 20</p>  <p>11 Schilder ML0802-8 Leonardo ML</p>	<p>Ø 1.05 5 10 15 20</p>  <p>11 ½ Schilder ML0802-9 Leonardo ML</p>	<p>Ø 1.20 5 10 15 20</p>  <p>10 Schilder ML0802-10 Leonardo ML</p>		

Vertical condensers

<p>Ø 0.5 5 10 15 20</p>  <p>FSR DENTIL 0802L-1 © Italy</p> <p>1 0802L-1 Asa60</p>	<p>Ø 0.7 5 10 15 20</p>  <p>2 0802L-2 Asa60</p>	<p>Ø 0.9 5 10 15 20</p>  <p>3 0802L-3 Asa60</p>	<p>Ø 1.1 5 10 15 20</p>  <p>4 0802L-4 Asa60</p>	<p>ENDODONTIC RULER</p>  <p>FSR DENTIL 0800 © Italy</p> <p>0800</p>
--	---	---	---	---

Root-canal Excavators

<p>Ø 1.2</p>  <p>FSR DENTIL 1709-31L © Italy</p> <p>31L 1709-31L Asa60 MV1709-31L Asa Light MV</p>	<p>Ø 1.5</p>  <p>32L 1709-32L Asa60 MV1709-32L Asa Light MV</p>	<p>Ø 2</p>  <p>33L 1709-33L Asa60 MV1709-33L Asa Light MV</p>
---	---	---

Endodontic instruments

Pliers for removing broken broaches



1
13 cm
0870-1



2
13 cm
0870-2

Forceps and pliers for silver cones



1 Stieglitz
0102-1



2 Stieglitz
0102-2

Photographic Mirrors

Occlusal surfaces

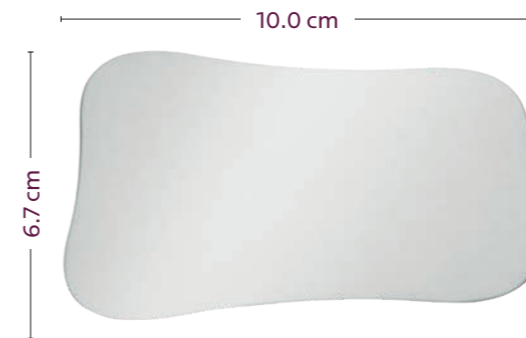

2250-1

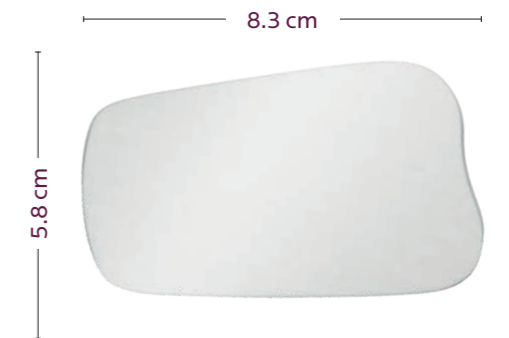

2250-2

Buccal surfaces



2250-3

Lingual surfaces

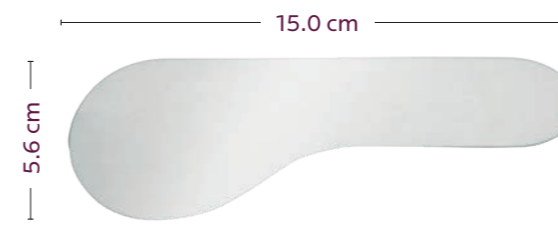

2250-4



2250-5

Simple stem Mouth Mirrors

box of 12



Simple stem Mouth Mirrors

single



parallelometer
2002-6
parallelometer + handle
S2002-6
Asa60

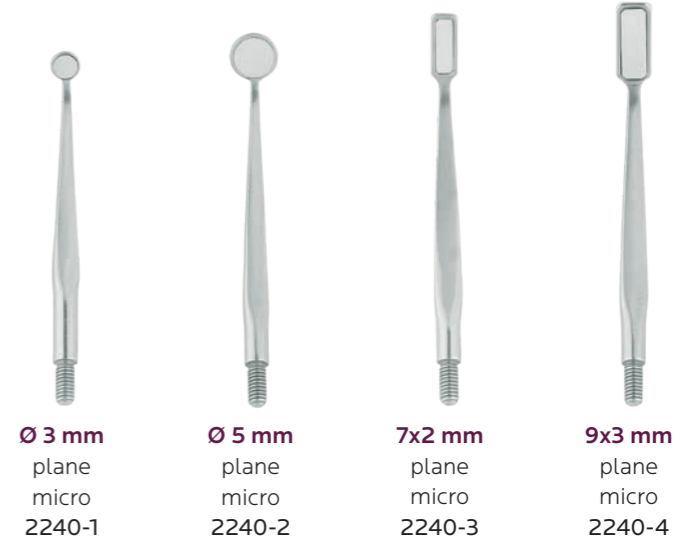

box of 12



Handles



S2100 Octagonal set of 5
S2101 Asa60 set of 5
S2102-IN Exagonal hollow set of 5
ML2101 Leonardo ML
2104-B ● Alu80
2104-C ● Alu80
2104-G ● Alu80
2104-R ● Alu80
2104-V ● Alu80
MC2101-B ● Magic Color MC

box of 12



5
Ø 22 mm
plane
2221-4

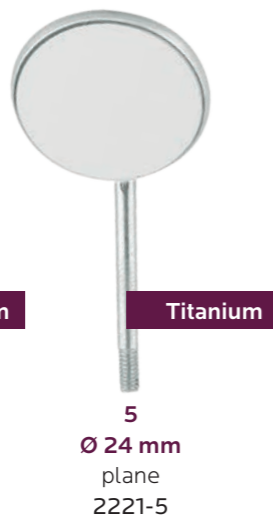

5
Ø 24 mm
plane
2221-5

box of 6



5
Ø 24 mm
plane
double sided
2230-5

Cone-socket Mouth Mirrors

box of 12



4
Ø 22 mm
2210E-4
plane

5
Ø 24 mm
2210E-5
plane

4
Ø 22 mm
2211E-4
magnifying

5
Ø 24 mm
2211E-5
magnifying

box of 6



5
Ø 24 mm
plane
double sided
2231-5CS

Handles



2100-CS
Octagonal

2101-CS
Asa60

2102-CS
Exagonal

Ultralight Mirror

technical data:
Philips shockproof miniature
lamps 2.25 V - 0.25 A
2 x 1.5 V alkaline batteries AAA type

spare parts:
0690-G o-ring
0690-L lamp
0690-M spring
0690-T head with mandrel



16 cm
0690



Ultralight Retractor

technical data:
Philips shockproof miniature
lamps 2.25 V - 0.25 A
2 x 1.5 V alkaline batteries AAA type



15 cm
0691



how to use the Ultralight Mirror and the Ultralight Retractor:

- insert 2 alkaline batteries
- take out the batteries prior to sterilization
- sterilizable O-ring on lamp to avoid penetration of saliva or liquid into the handle, thus preserving battery life
- easy light on/off through bottom cap
- no maintenance required for electrical or mechanical parts
- full disassembly for proper cleaning
- easy change of batteries and lamps
- ergonomic handle

Ultralight kit with mirror and retractor in a mini locking tray

content:
0690 ultralight mirror
0691 ultralight retractor
2772-1 locking tray mini



S0690-2

First examination instrument kit



S0600-6

- content:
- 6 anatomic handle explorer 0700-6
 - 2 London-College cotton and dressing pliers 0601-2
 - anatomic mouth mirror handle 2101
 - 4 plane mouth mirror 2200-4

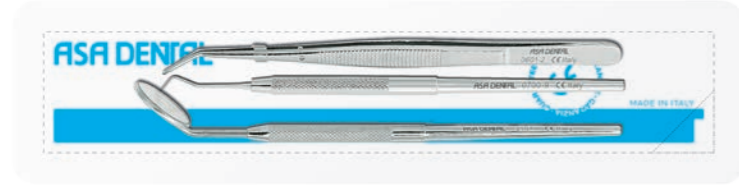

S0600-9

- content:
- 9 anatomic handle explorer 0700-9
 - 2 London-College cotton and dressing pliers 0601-2
 - anatomic mouth mirror handle 2101
 - 4 plane mouth mirror 2200-4

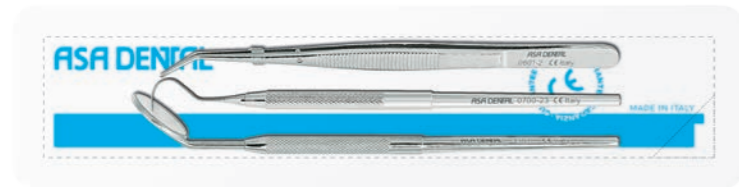

S0600-23

- content:
- 23 anatomic handle explorer 0700-23
 - 2 London-College cotton and dressing pliers 0601-2
 - anatomic mouth mirror handle 2101
 - 4 plane mouth mirror 2200-4

First examination instrument kit - AsaLady

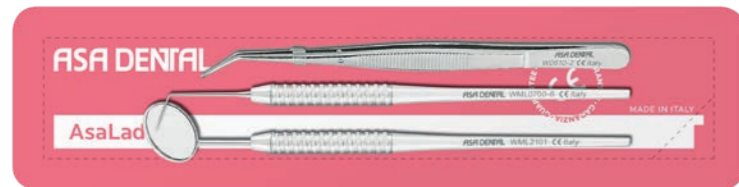

SWML0600-6

- content:
- 6 anatomic handle explorer WML0700-6
 - 2 London-College cotton and dressing pliers WML0610-2
 - Leonardo mouth mirror handle WML2101
 - 4 plane mouth mirror 2200-4

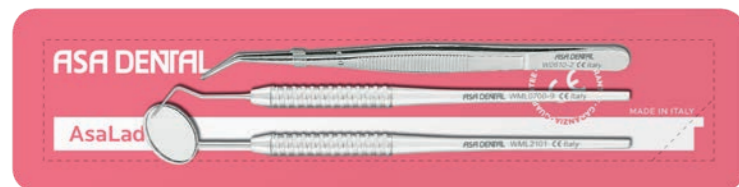

SWML0600-9

- content:
- 9 anatomic handle explorer WML0700-9
 - 2 London-College cotton and dressing pliers WML0610-2
 - Leonardo mouth mirror handle WML2101
 - 4 plane mouth mirror 2200-4

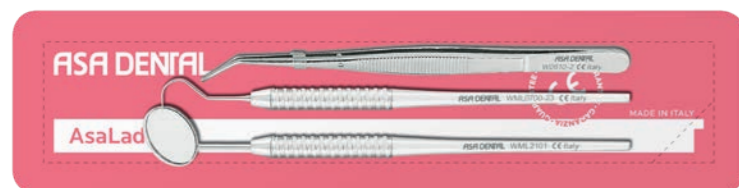

SWML0600-23

- content:
- 23 anatomic handle explorer WML0700-23
 - 2 London-College cotton and dressing pliers WML0610-2
 - Leonardo mouth mirror handle WML2101
 - 4 plane mouth mirror 2200-4

First examination instrument kit - Magic Color



SMC0600-6

- content:
- 6 Magic Color handle explorer MC0700-6
 - 2 London-College cotton and dressing pliers 0601-2
 - Magic Color mouth mirror handle MC2101-B
 - 4 plane mouth mirror 2200-4



SMC0600-9

- content:
- 9 Magic Color handle explorer MC0700-9
 - 2 London-College cotton and dressing pliers 0601-2
 - Magic Color mouth mirror handle MC2101-B
 - 4 plane mouth mirror 2200-4



SMC0600-23

- content:
- 23 Magic Color handle explorer MC0700-23
 - 2 London-College cotton and dressing pliers 0601-2
 - Magic Color mouth mirror handle MC2101-B
 - 4 plane mouth mirror 2200-4



Magic Color instrument kit

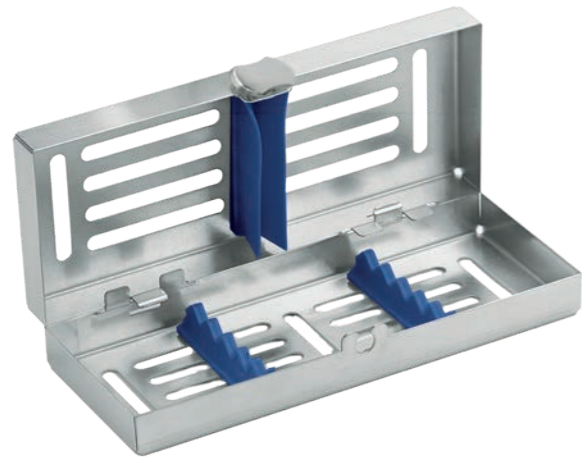

Diagnostic instruments kit
SMC0700-5



	mouth mirror handle	MC2101-B
4	plane mouth mirror	2200-4
	Williams probe	MC0703-14
23/17	d/e explorer	MC0704-23D1
2	excavator	MC1700-2
2	London-College cotton and dressing pliers	0601-2
	mini locking tray	2772-1

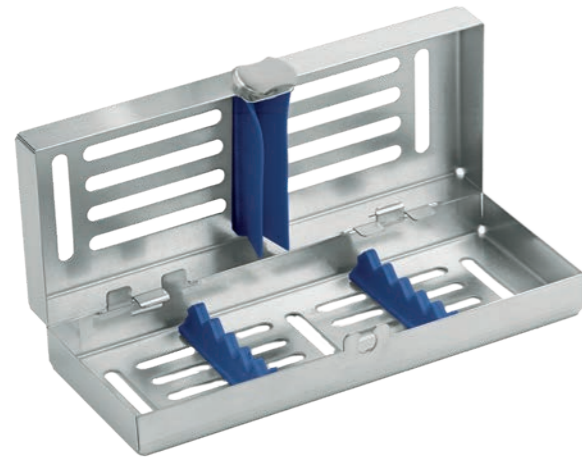

Endodontic instruments kit
SMC0800-5



6/9	d/e explorer	MC0704-6D9
1	excavator	MC1700-1
1	spreader/plugger	MC0803-1
1/2	Hollenback	MC1500-02
2	London-College cotton and dressing pliers	0601-2
	mini locking tray	2772-1

Endodontic kit



set
7 Laser System instruments
S0702L-7



Boston university
set 23 instruments
S0702L-23



Endodontic set
S0800

CP-12S	laser colour coded O.M.S periodontal pocket probe	0702L-12S
CP-12	laser colour coded periodontal pocket probe	0702L-12
	laser colour coded Williams explorer	0703L-1
	laser colour coded Goldman-Fox explorer	0703L-4
23/CP-12	combined laser colour coded explorer/probe	0706L-2312
1	laser colour coded vertical condenser	0802L-1
2	laser colour coded vertical condenser	0802L-2
	endodontic ruler	0800
	complete perforated instrument tray	S2702

2	London-College cotton and dressing pliers	0601-2
	anatomic mouth mirror handle	2101
4	plane mouth mirror	2200-4
	endodontic ruler	0800
23/17	Asa Light double ended explorer	MV0704-23D1
6/1	Asa Light root canal explorer	MV0710-6D1
16	Asa Light Williams combined explorer/probe	MV0705-16W
3	Asa Light Goldman-Fox combined explorer/probe	MV0705-3GF
CP-12S	laser colour coded O.M.S. periodontal pocket probe	0702L-12S
CP-12	laser colour coded periodontal pocket probe	0702L-12
CP-11	laser colour coded periodontal pocket probe	0702L-11
23/CP-12	laser colour coded combined explorer/probe	0706L-2312
1	spreader	0800-1
32L	Asa Light root canal excavator	MV1709-32L
19	Asa Light double ended excavator	MV1706-19
14	Asa Light double ended excavator	MV1703-14
1	Asa Light double ended excavator	MV1701-1
1/2	Asa Light Gracey curette	MV1807-02
3/4	Asa Light Gracey curette	MV1807-04
5/6	Asa Light Gracey curette	MV1807-06
7/8	Asa Light Gracey curette	MV1807-08
9/10	Asa Light Gracey curette	MV1807-10
11/12	Asa Light Gracey curette	MV1807-12
13/14	Asa Light Gracey curette	MV1807-14
	perforated instrument tray	S2721-2

	Aluminium endodontic instrument cleaner	AL2746-1
	Measuring plate	0800
	London-College cotton and dressing pliers	0601-2
	Handle for mouth mirror, round	2101
4	Mouth mirror plane	2200-4
6/1	Root canal explorer	0710-6D1
31L	Root canal excavator	1709-31L
1	Spreader	0800-1
	Insert frame for 7 instruments in stainless steel	2700-G
	Complete perforated instrument tray	S2702



ORAL SURGERY

MADE IN ITALY

ALL THE NECESSARY SURGICAL PRECISION

As a dental professional, you know that the more a procedure is invasive the clearer your communication with your patient must be. Answering questions like “How complicated it is?”, “How long will it take?” and “What could go wrong?” becomes as important as the intervention itself. Your job includes explaining the patient that the combination of your unique skills with the precision our instruments ensures the optimal outcome in the shortest time. We know that, and we answer the call of professionals like you asking for ergonomic instruments reliable over time and use that help reducing complexity and preventing complications.

- C3 Scissors
- C10 Needle holders
- C20 Hemostats
- C24 Scalpels
- C28 Syringes
- C31 Towel clamps
- C32 Dressing forceps
- C33 Mouth gags
- C33 Tongue forceps
- C34 Retractors
- C37 Antrum probes
- C38 Tissue pliers
- C44 Aspirators
- C45 Bone curettes
- C46 Kits

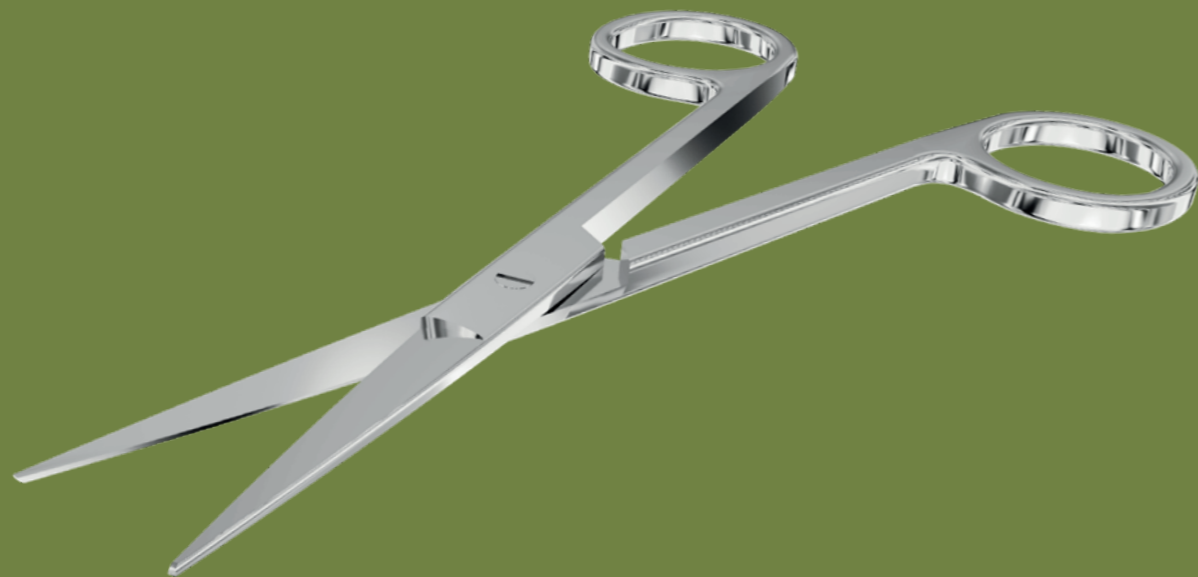

Handle options

DOUBLE END

Asa60
(stainless steel)
ø 6.0 mm

Asa Light MV
(stainless steel, hollow)
ø 8.0 mm

Leonardo ML
(stainless steel)
ø 7.0 mm

● Magic Color MC
(aluminum core and
non-slip plastic)
ø 8.0 / 10.5 mm

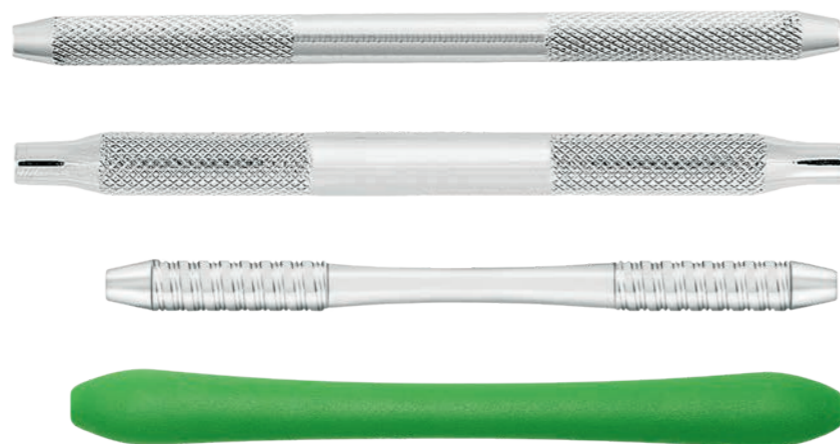

standard instrument



instrument with tungsten carbide (TC) inserts

How to use

- 1 Hemingway → pattern + scientific name
- MC2000-1 → Asa Dental code
- Magic Color MC → handle option

AsaLady

- products ergonomically designed for women hands:
- smaller and lighter handles
 - smaller finger holes
 - reduced size
 - code starts with "W" or "SW"

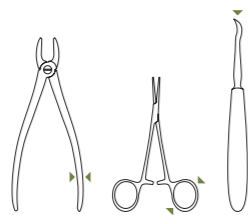

* these products are not manufactured by Asa Dental and are distributed under manufacturer brand

Gum scissors



1
straight
12 cm
0300-1



2
curved
12 cm
0300-2



1
straight
12 cm
W0319-1



2
curved
12 cm
W0319-2



1
angular
11.5 cm
0301-1



1
angular
one blade serrated
11.5 cm
0301-2



1 Goldman-Fox
straight
one blade serrated
13 cm
0304-1



2 Goldman-Fox
curved
one blade serrated
13 cm
0304-2

Gum scissors

Gum scissors



1 Iris
straight
11.5 cm
0305-1



2 Iris
curved
11.5 cm
0305-2



1TC Iris
straight
11 cm
0305-1TC



2TC Iris
straight
11 cm
0305-2TC



3 Iris
curved
11.5 cm
0305-3



1 Quinby
straight
12.5 cm
0308-1



2 Quinby
curved
12.5 cm
0308-2



3 Goldman-Fox (special)
curved
one blade serrated
13 cm
0304-3



1TC Goldman-Fox
straight
13 cm
0304-1TC



2TC Goldman-Fox
curved
13 cm
0304-2TC



1TC Goldman-Fox
curved
17 cm
0306-1TC



1 Kelly
straight
16 cm
0309-1



2 Kelly
curved
16 cm
0309-2



1TC Kelly
straight
16 cm
0309-1TC



2TC Kelly
curved
16 cm
0309-2TC

Gum scissors



1 Sullivan
straight
one blade serrated
14.5 cm
0311-1



2 Sullivan
curved
one blade serrated
14.5 cm
0311-2



1TC Locklin
angular
16.5 cm
0310-1TC



1 Neumann
curved
12.5 cm
0302-1



1 Dean
curved
one blade serrated
17 cm
0306-1



1 La Grange
curved
one blade serrated
10.5 cm
0307-1



1 Locklin
angular
one blade serrated
16.5 cm
0310-1



2 Locklin
angular
one blade serrated
16.5 cm
0310-2



2TC Locklin
angular
16.5 cm
0310-2TC



1 Noyes (Castroviejo)
curved
very thin beaks
12 cm
0303-1



1 Westcott
curved
sharp beaks
11 cm
0312-1



2 Westcott
curved
blunt beaks
11 cm
0312-2



1
curved
very thin beaks
14.5 cm
0313-1

Gum scissors

suture scissors



1 Spencer
9 cm
0320-1



2 Spencer
13 cm
0320-2



1 Mayo
straight
14.5 cm
0325-1



2 Mayo
curved
14.5 cm
0325-2



Stevens
straight
11.5 cm
0330-1



Stevens
curved
11.5 cm
0330-2



Stevens
rounded straight beaks
11.5 cm
0329-1

dissecting scissors



1 Metzenbaum
straight
14.5 cm
0321-1



2 Metzenbaum
curved
14.5 cm
0321-2



1 Metzenbaum-Delikat
straight
14.5 cm
0322-1



2 Metzenbaum-Delikat
curved
14.5 cm
0322-2



Stevens
straight
11.5 cm
0328-1



Stevens
curved
11.5 cm
0328-2



Stevens
rounded curved beaks
11.5 cm
0329-2

Needle holders



Olsen-Hegar
scissors combined
14 cm
0400-14



TC Olsen-Hegar
14 cm
0405-14TC



Baumgartner
14.5 cm
0404-14



TC Hegar-Baumgartner
14 cm
0409-14TC



Crile-Wood
15 cm
W0411-15

AsaLady



Crile-Wood
15 cm
0410-15



TC Crile-Wood
15 cm
0415-15TC



Adson
17.5 cm
0403-17



TC Crile-Wood
15 cm
W0411-15TC

AsaLady

0409-14TC



Needle holders



Mayo-Hegar
16 cm
0420-16



TC Mayo-Hegar
16 cm
0425-16TC



Mayo-Hegar
16 cm
W0412-16
AsaLady



Derf
12 cm
0401-12



TC Derf
12 cm
0406-12TC



TC Halsey-Smooth
smooth jaws
13 cm
0407-13TC



Mayo-Hegar
18 cm
0420-18



TC Mayo-Hegar
18 cm
0425-18TC



TC Mayo-Hegar
16 cm
W0412-16TC
AsaLady



TC Mini-Ryder
18 cm
0416-18TC



TC Mini-Ryder
15 cm
0416-15TC



TC Halsey
13 cm
0408-13TC

Needle holders

Needle holders



Gillies
scissors combined
16 cm
0414-16



TC Gillies
scissors combined
16 cm
0419-16TC



TC Fine Swedish
15 cm
0417-15TC



Lichtenberg
smooth action
17 cm
0432-17



TC Lichtenberg
17 cm
0437-17TC



Eiselberg-Mathieu
19.5 cm
0422-19



Toennis
light pattern
18 cm
0421-18



TC Toennis
light pattern
18 cm
0426-18TC



TC Micro-Vascular
15 cm
0418-15TC



Arruga
16 cm
0433-16



TC Arruga
16 cm
0438-16TC

Needle holders

Needle holders



Mathieu
14 cm
0430-14



Mathieu
14 cm
0431-14



Mathieu
scissors combined
14 cm
0432-14



TC Mathieu
14 cm
0435-14TC



TC Mathieu
14 cm
0436-14TC



TC Micro-Barraquer
with curved jaws
18 cm
0451-18TC



Mathieu
17 cm
0430-17



Mathieu
17 cm
0431-17



TC Mathieu
14 cm
0432-14TC



TC Mathieu
17 cm
0435-17TC



TC Mathieu
17 cm
0436-17TC



TC Micro-Barraquer
18 cm
0450-18TC

Needle holders



TC Castroviejo
with curved jaws
15.5 cm
PR0460-15TC



Castroviejo
14 cm
0440-14



Castroviejo
with curved jaws
14 cm
0441-14



Castroviejo
14 cm / 60°
0443-14



TC Castroviejo
14 cm
0445-14TC



TC Castroviejo
14 cm
0446-14TC



TC Castroviejo
14 cm / 60°
0448-14TC

Needle holders



Castroviejo
13 cm
0442-13



Castroviejo
smooth jaws
13 cm
0442-13L



Castroviejo-Barraquer
smooth jaws
12 cm
0444-12L



TC Castroviejo
13 cm
0447-13TC



Castroviejo
18 cm
0440-18



Castroviejo
with curved jaws
18 cm
0441-18



TC Castroviejo
18 cm
0445-18TC



TC Castroviejo
18 cm
0446-18TC

Hemostats



1 Crile straight
14 cm
0520-1



2 Crile curved
14 cm
0520-2



1 Kocher 1x2 straight
14 cm
0530-1



1 Halstead-Mosquito straight
12 cm
0500-1



1 Halstead-Mosquito straight
12 cm
W0502-1



2 Halstead-Mosquito curved
12 cm
0500-2



2 Kocher 1x2 curved
14 cm
0530-2



1 Pean straight
14 cm
0540-1



2 Pean curved
14 cm
0540-2



2 Halstead-Mosquito curved
12 cm
W0502-2



1 Halstead-Mosquito 1x2 straight
12 cm
0505-1



2 Halstead-Mosquito 1x2 curved
12 cm
0505-2

Hemostats



1 Micro-Mosquito
straight
10 cm
0501-1



2 Micro-Mosquito
curved
10 cm
0501-2



1 Micro-Mosquito 1x2
straight
10 cm
0506-1



2 Micro-Mosquito 1x2
curved
10 cm
0506-2

Hemostats



1 Kelly
straight
14 cm
0510-1



2 Kelly
curved
14 cm
0510-2



1 Hartmann
straight
10 cm
0515-1



2 Hartmann
curved
10 cm
0515-2



Orientable blade scalpel handle

Scalpel blade remover

Disposable scalpels *

100 pcs / box



0371-10
Sharp and thin, the blade of our disposable scalpels maintain its characteristic throughout the surgery intervention whether it is used superficially or at the periosteal tissue plane.



16 cm
0335-1

16.5 cm
0352



S0352
kit of 0352 scalpel blade remover +
0335-1 orientable blade scalpel handle



0371-10

0371-11

0371-12

0371-15

Scalpel handles



Scalpel blades *

100 pcs (sterile) / box



Scalpel handles



Scalpel blades *

100 pcs (sterile) / box



Micro-blades *

25 pcs (sterile) / box



Syringes

non self-aspirating



1.8 ml cartridge
metric thread
0483-2



1.8 ml cartridge
metric thread
0483-3



2.2 ml cartridge
imperial thread (Withworth)
0482-3W



2.2 ml cartridge
imperial thread (Withworth)
0482-4W

Syringes

cork screw tip



1.8 ml cartridge
metric thread
0480-1



1.8 ml cartridge
metric thread
0480-2



1.8 ml cartridge
metric thread
0480-4

self-aspirating



1.8 ml cartridge
metric thread
0480-5



1.8 ml cartridge
metric thread
0480-6



1.8 ml cartridge
metric thread
0483-1



2.2 ml cartridge
imperial thread (Withworth)
0482-6W



1.8 ml cartridge
imperial thread (Withworth)
0480-4W



1.8 ml cartridge
metric thread
0480-3

spare caps for
0480-1
0480-2
0480-3
0480-4



metric thread
0480-P1



imperial thread (Withworth)
0480-P2

Syringes

intra-ligamental syringes

stainless steel syringe



1.8 ml cartridge
metric thread
0481-8

brass syringes with stainless steel moving parts

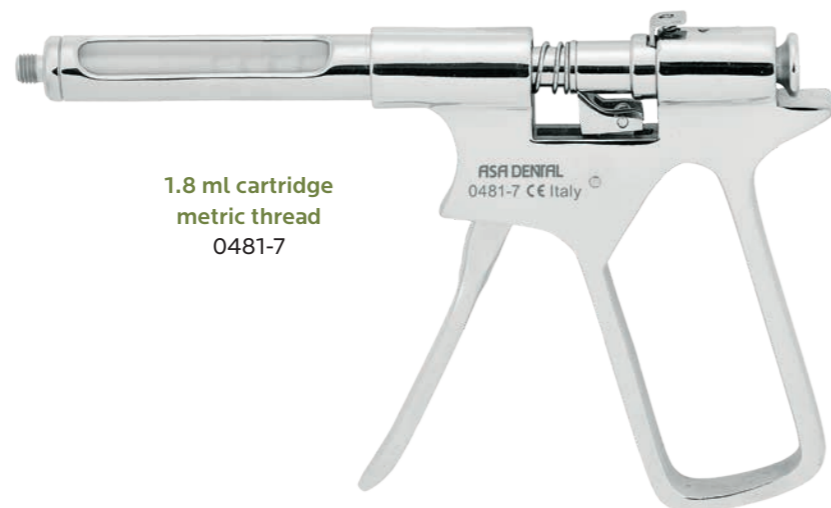

1.8 ml cartridge
metric thread
0481-7



2.2 ml cartridge
imperial thread (Withworth)
0482-7W

autoclavable plastic protection sleeve



0481-T1

syringe stand



0482-1

Towel clamps



1 Backhaus
8 Cm
0550-1



2 Backhaus
11 Cm
0550-2



3 Backhaus
13 Cm
0550-3



Schaedle
9 Cm
0680



Jones
9 Cm
0681



Dressing forceps



Gross-Maier
straight
20 cm
0555-1



Gross-Maier
straight
25 cm
0557-1



Gross-Maier
curved
20 cm
0555-2



Gross-Maier
curved
25 cm
0557-2

Mouth gags

for adults



Molt
14 cm
1870-2



Roser-Koenig
19 cm
1871-2

for children



Molt
11 cm
1870-1



Roser-Koenig
16 cm
1871-1

Tongue forceps



Collin
16 cm
0560



Young
17 cm
0561

Retractors - Tongue depressors

lip retractors

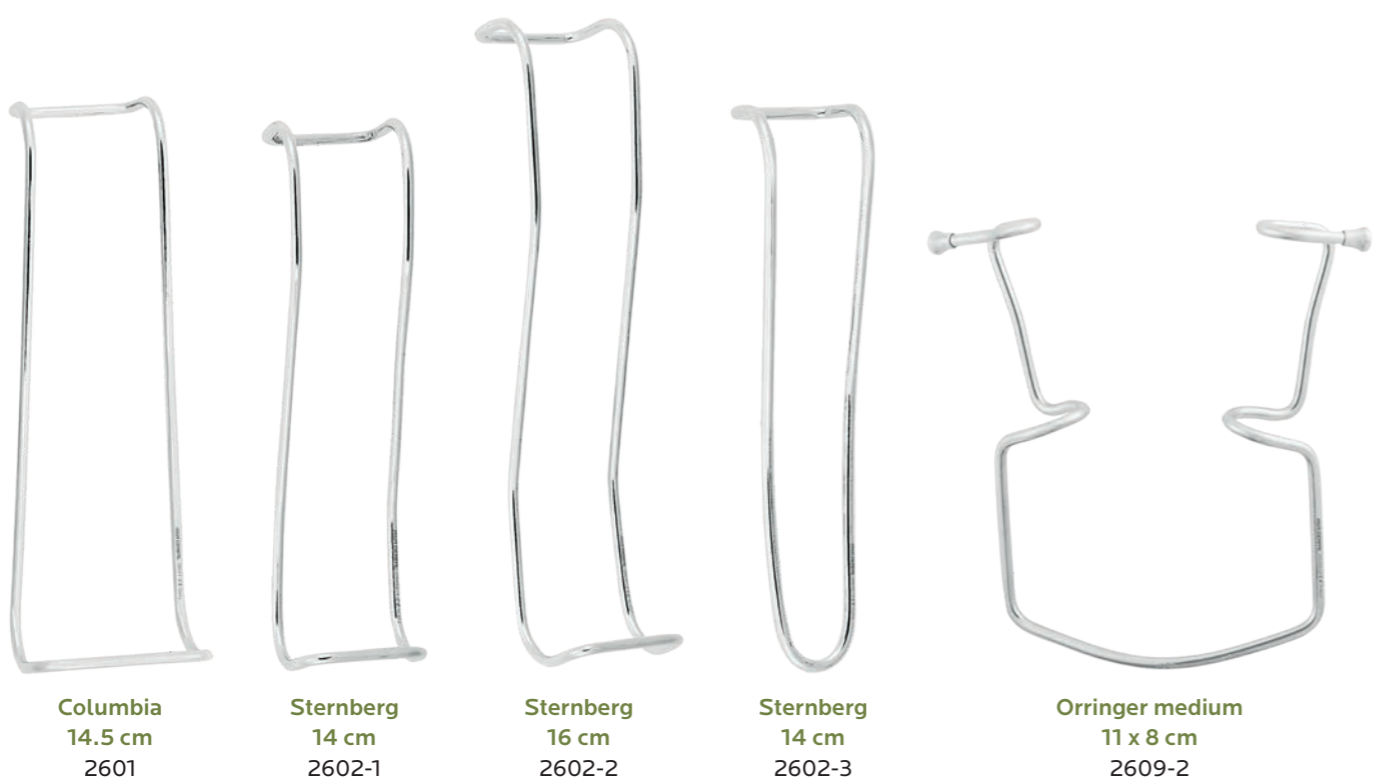

Columbia
14.5 cm
2601

Sternberg
14 cm
2602-1

Sternberg
16 cm
2602-2

Sternberg
14 cm
2602-3

Orringer medium
11 x 8 cm
2609-2

tongue depressor



14.5 cm
2605

14.5 cm
2606

Buchwald
17 cm
2607

Brünings
19 cm
2608

cheek retractor



University of Minnesota
14 cm
2604

Retractors



blunt
16 cm
2611-2

Senn-Miller
blunt
16 cm
2613-2

blunt
16 cm
2611-1

Senn-Miller
sharp
16 cm
2613-1

Kilner
15 cm
2615-1

Farabeuf
13 cm
2616-1



Williger
left
sharp
13 cm
2617-2

Williger
right
sharp
13 cm
2617-3

Williger
right
sharp
13 cm
2617-33

Williger
straight
sharp
13 cm
2617-1

Williger
straight
blunt
13 cm
2618-1

Williger
left
blunt
13 cm
2618-2

Retractors



Retractors



Antrum probes

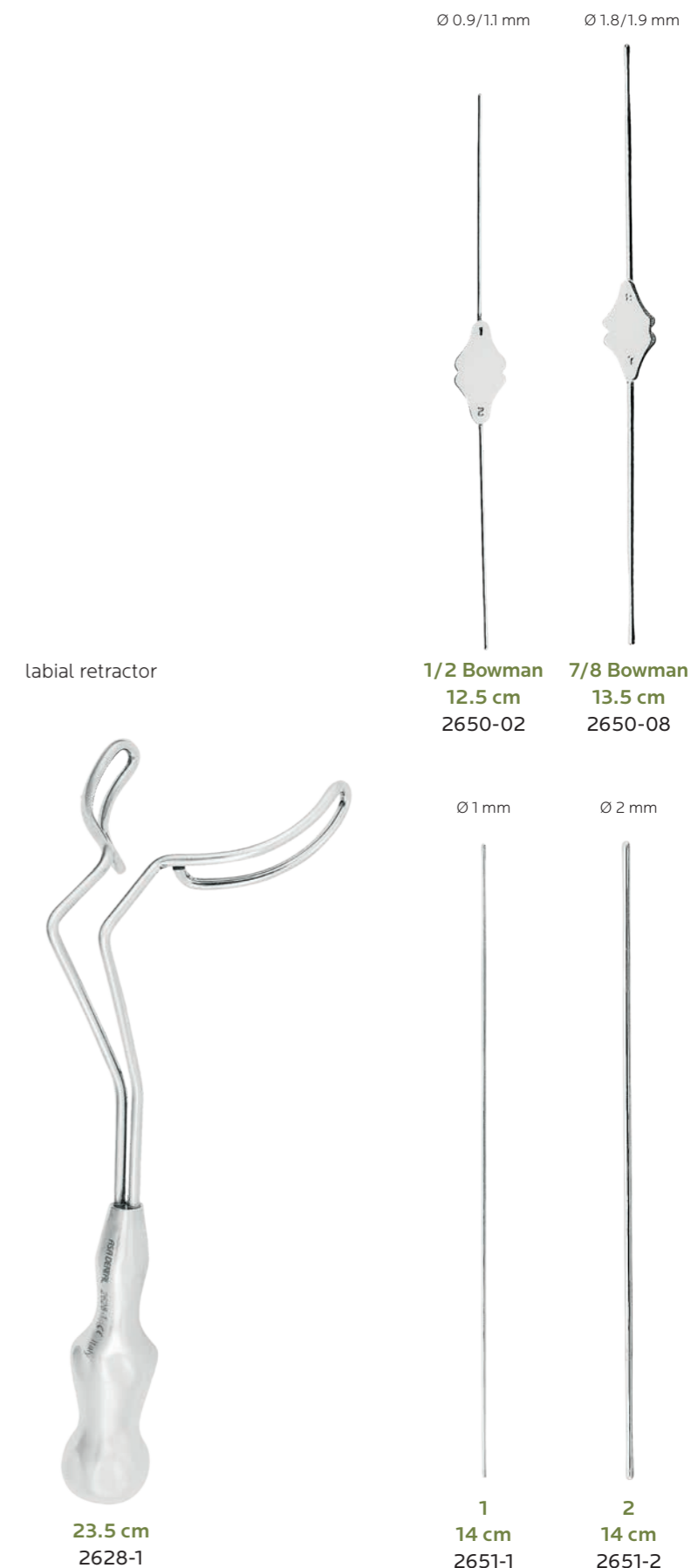

Tissue pliers



PR0632-1
 ATRAUMATIC TISSUE PLIERS WITH THIN TIPS
 allow maximum ease of handling in mobilizing
 the soft tissue and in suturing.

0.8mm



Cooley
 17.5 cm
 PR0632-1



1
 Adson
 12 cm
 0620-1



1
 Adson 1x2
 12 cm
 0621-1



1
 Micro-Adson 1x2
 12 cm
 0622-1

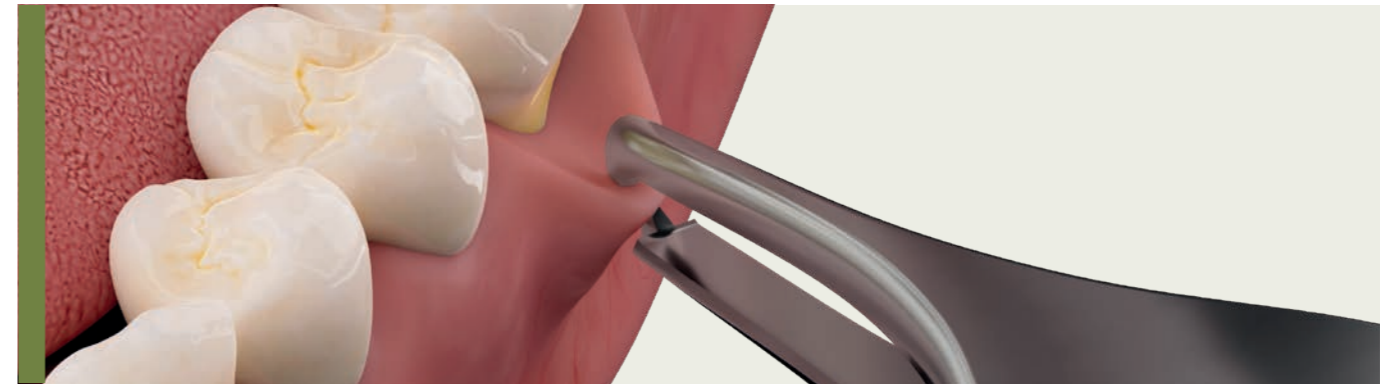

0622-2



2
 Micro-Adson 1x2
 15 cm
 0622-2



10 cm
 0623-1



Micro-Adson
 12 cm
 0624-1



Micro-Adson
 15 cm
 0624-2

Tissue pliers

suture pliers

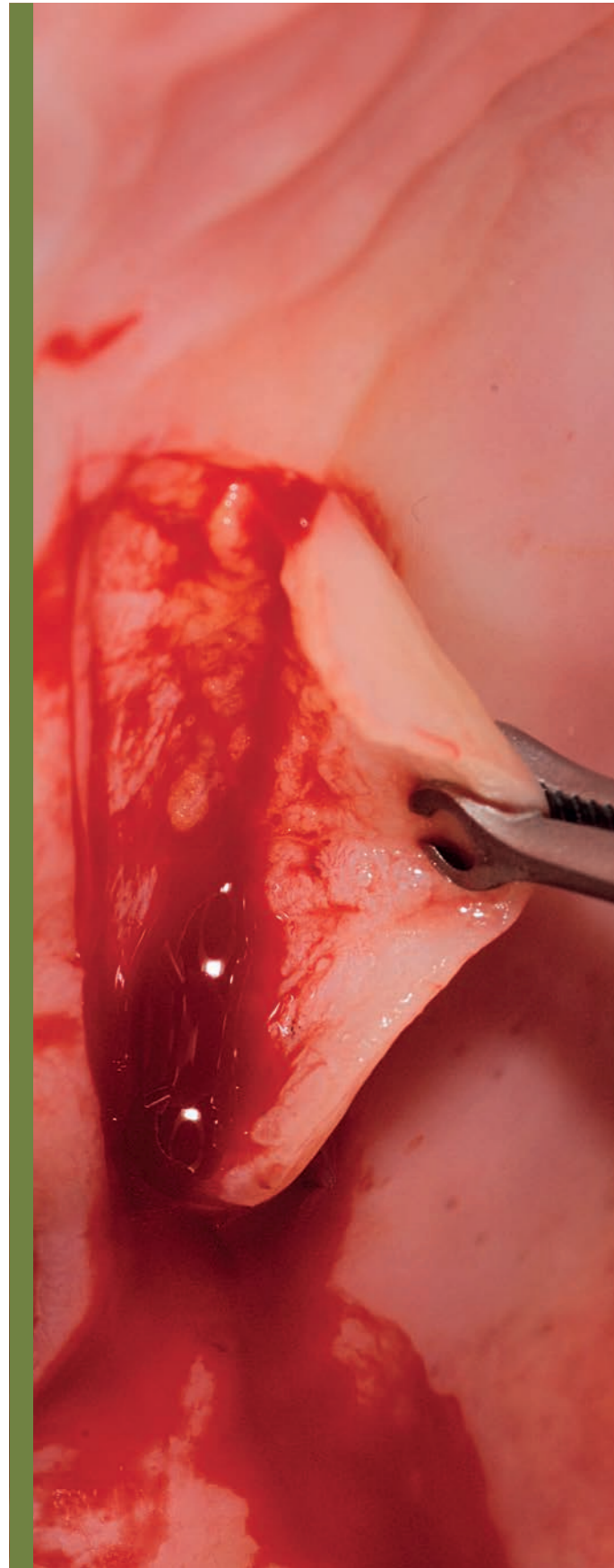

PR0625-3
Allows atraumatic manipulation
of the soft tissue and facilitate suturing



16 cm
PR0625-2



17 cm
PR0625-3



1
15 cm
0625-1



Adson Brown
non traumatic
12 cm
0626-1



1
Semken-Taylor
12.5 cm
0630-1



2
Semken-Taylor
12.5 cm
0630-2



1
Semken-Taylor 1x2
12.5 cm
0631-1



2
Semken-Taylor 1x2
12.5 cm
0631-2

Tissue pliers

set of 5



1 · 2 · 3 · 4 · 5
S0645

very thin tips



1
12.5 cm
0645-1



2
12 cm
0645-2



3
11.5 cm
0645-3



4
11.5 cm
0645-4



5
11.5 cm
0645-5



1
13 cm
0635-1



2
14 cm
0635-2



3
15 cm
0635-3



4
18 cm
0635-4



5
20.5 cm
0635-5

Tissue pliers

Surgical stainless steel saliva ejectors



Surgical aspirator tips

aspirator tips specially shaped for surgical use, autoclavable



Bone curettes



1 Hemingway
2000-1
Asa60
MV 2000-1
Asa Light MV
ML2000-1
Leonardo ML
MC2000-1
● Magic Color MC

2 Hemingway
2000-2
Asa60
MV 2000-2
Asa Light MV
ML2000-2
Leonardo ML
MC2000-2
● Magic Color MC

3 Hemingway
2000-3
Asa60
MV 2000-3
Asa Light MV
ML2000-3
Leonardo ML
MC2000-3
● Magic Color MC

3
2014-3

Instruments kit for oral surgery



S3002-13

2	cotton and dressing pliers	0602-2
3	tissue pliers	0635-3
1	suture pliers	0625-1
	retractor	2611-2
	Mathieu needle holder	0430-14
	Castroviejo needle holder	0441-14
	scalpel handle	0350-3
	straight Spencer surgical scissors	0320-2
2	curved Metzenbaum surgical scissors	0321-2
	mouth mirror handle	2102-IN
	Buchwald retractor	2607
4	mouth mirror	2200-4
	tray	S2722-1

Instruments kit for oral surgery

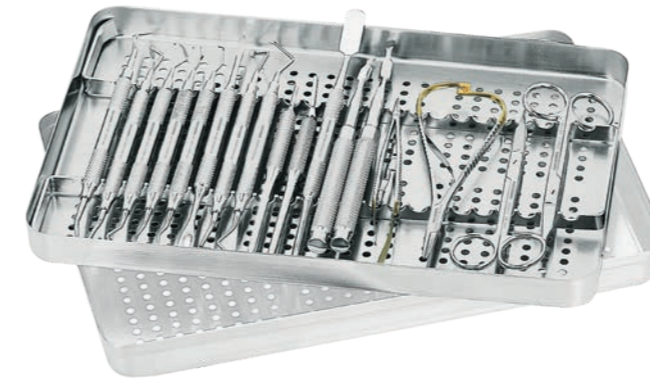

S3002-18

7/8	Gracey curette	MV1807-08
11/12	Gracey curette	MV1807-12
13/14	Gracey curette	MV1807-14
1	straight Goldman-Fox scissors	0304-1
2	curved Goldman-Fox scissors	0304-2
85	Lucas bone curette	MV2001-85
86	Lucas bone curette	MV2001-86
1/2	Kirkland knives	MV1803-D
1/2	Orban knives	MV1804-D
M9	Molt periosteal elevator	MV1850-M9
PR3	Prichard periosteal elevator	MV1851-PR3
5	straight scalpel handle	0350-5
5A	curved scalpel handle	0350-5A
1	Ochsenbein chisel	1800-1
2	Ochsenbein chisel	1800-2
	Castroviejo needle holder	0445-14TC
	Mathieu needle holder	0435-14TC
	tray	S2722-2



S3002-17

	mouth mirror handle	2102-IN
23	explorer	0700-23
2	London-College cotton and dressing pliers	0601-2
1	Semken-Taylor tissue pliers	0631-1
7	Goldman-Fox knives	1815-7
1/2	Orban knives	1804-D
M9	Molt periosteal elevator	MV1850-M9
PR3	Prichard periosteal elevator	MV1851-PR3
	Farabeuf retractor	2616-1
	Sternberg retractor	2602-1
	Senn-Miller retractor	2613-2
	Crile-Wood needle holder	0415-15TC
	Mathieu needle holder	0430-14
2	Goldman-Fox scissors	0304-2
1	straight Halstead-Mosquito Hemostats	0500-1
2	curved Halstead-Mosquito Hemostats	0500-2
5	mouth mirror	2200-5
	tray	S2722-1



EXTRACTIVE SURGERY

MADE IN ITALY

FIX IT NOW BUT THINK LONG TERM

Removing a tooth is always an extreme measure, most of the time supposed to solve a painful situation for the patient. Even the simplest extractions demand the most careful manoeuvres, aiming at preserving the bone as much as possible without compromising the possibility of future implants. Yet, both your experience and medical literature tell you that there are cases demanding for procedures that are far more complex. A molar broken off at the gum line, an included or semi-included wisdom tooth, a non-erupting molar: the extraction turns into a real surgery with the necessity to create an access through the gum and minimize the amount of sacrificed bone. Being minimally invasive and extremely precise requires you a broad range of superior performance instruments, including a large variety of tooth-dedicated levers to address any type of intervention. This is what you find here.

- D4 Extracting forceps
- D37 Extracting forceps for children
- D40 Extracting forceps for roots
- D42 Bone rongeurs
- D44 Nippers
- D45 Root elevators
- D63 Root-tip picks
- D65 Syndesmotomes
- D68 Periotomes
- D68 Exciser
- D69 Kits
- D71 Accessories

Extracting forceps - range of application

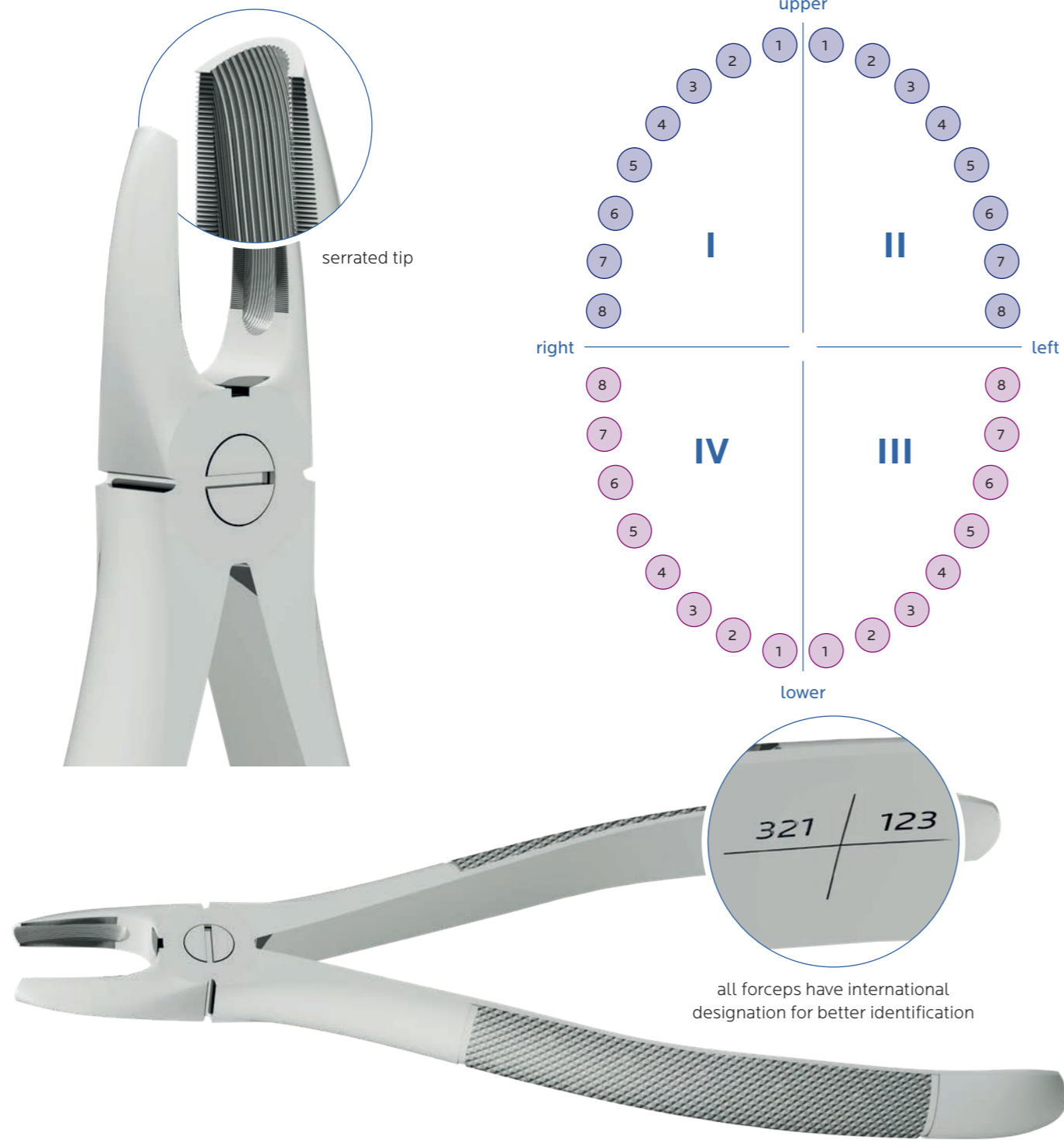

How to use

AsaLady

- products ergonomically designed for women hands:
- smaller and lighter handles
- smaller finger holes
- reduced size
- code starts with "W" or "SW"

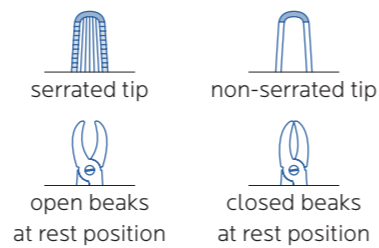
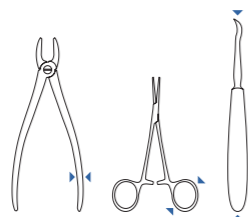

		incisors and canines		pre-molars		molars		roots		third molars		for children	
		lower	upper	lower	upper	lower	upper	lower	upper	lower	upper	lower	upper
0100-1	W0160-1		•										
0100-2	W0160-2		•										
0100-3			•										
0100-4	W0160-4	•											
0100-7	W0160-7				•								
0100-8					•								
0100-13	W0160-13				•								
0100-17	W0160-17						•						
0100-18	W0160-18						•						
0100-18A							•						
0100-19											•		
0100-20											•		
0100-21	W0160-21						•						
0100-22	W0160-22						•						
0100-22L							•						
0100-22R							•						
0100-23													
0100-24							•						
0100-29													
0100-29N			•										
0100-30													
0100-31			•										
0100-33	W0160-33												
0100-33A													
0100-33L													
0100-38A													
0100-41													
0100-43A													
0100-44													
0100-45	W0160-45												
0100-46													
0100-46L													
0100-48													
0100-49													
0100-51													
0100-51A	W0160-51A												
0100-51L													
0100-51LX													
0100-52			•										
0100-54													
0100-55													
0100-56													
0100-59													
0100-59L			•										
0100-60													
0100-65L													
0100-65R													
0100-66L													
0100-66R													
0100-67													
0100-67A	W0160-67A												
0100-67/L													
0100-67/R													
0100-68													
0100-73													
0100-74	W0160-74												
0100-74M			•										
0100-74N													
0100-75			•										
0100-79	W0160-79												
0100-79A													
0100-79C													
0100-86/L													
0100-86/R													
0100-86C	W0160-86C												
0100-86W													
0100-87													
0100-89													
0100-90													
0100-99													
0100-107			•										
0100-121													
0100-145	W0160-145												
0100-151/	W0160-151/												
0100-151/													
0100-166													
0100-167													
0100-168			•										
0100-169			•										
0100-346													
0100-349													
0100-359													
0104-1			•										
0104-2													
0104-3			•										
0104-4			•										
0120-5	W0121-5												
0120-6	W0121-6												
0120-10S	W0121-10S												
0120-16	W0121-16												
0120-17	W0121-17												
0120-18L	W0121-18L												
0120-18R	W0121-18R												
0120-23	W0121-23												
0120-53R	W0121-53R												
0120-53L	W0121-53L												
0120-65	W0121-65												
0120-69	W0121-69												
0120-88R	W0121-88R												
0120-88L	W0121-88L												
0120-101	W0121-101												
0120-150	W0121-150												
0120-150S	W0121-150S												
0120-151	W0121-151												
0120-151S	W0121-151S												
0120-222	W0121-222												
0130-1													
0130-2													
0130-4													
0130-7													
0130-13													
0130-17													
0130-18													
0130-21													
0130-22													
0130-33													
0130-45													
0130-51A													
0130-67A													
0130-74													
0130-79													
0130-86C													
0130-89													
0130-90													
0130-145													
0130-151/													
0130-349													
0130-359													
0110-37													
0110-39													
0110-39R													
0110-39L													
0110-51S													
0110-13S													
0110-22S													
0110-30S													
0110-33S													
0110-38													
0112-1													
0112-2													
0112-3													
0112-4													
0112-5													
0112-6													
0112-7													
0101-1													
0101-2													
0102-1													
0102-2													

Extracting forceps

serrated tips



S0100-1

1	0100-1
17	0100-17
18	0100-18
79	0100-79
67A	0100-67A
51A	0100-51A
13	0100-13
22	0100-22



1
17 cm
0100-1
upper incisors
and canines

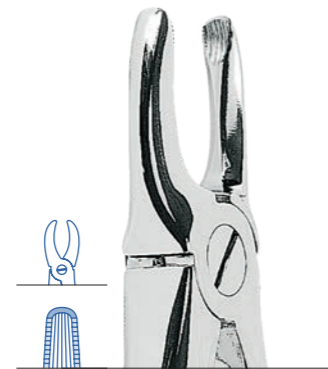

3
17 cm
0100-3
overlapping upper
incisors and canines



7
17 cm
0100-7
upper incisors
upper premolars

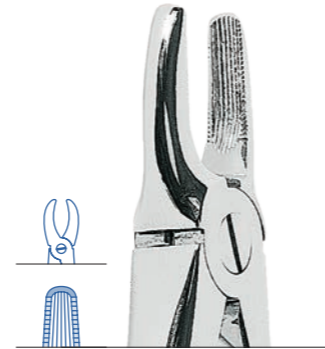

2
18 cm
0100-2
upper incisors
and canines

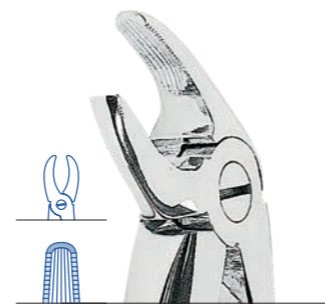

4
14 cm
0100-4
lower incisors
and canines



8
16 cm
0100-8
lower premolars

Extracting forceps

serrated tips



S0100-2

1	0100-1
7	0100-7
17	0100-17
18	0100-18
4	0100-4
13	0100-13
22	0100-22
86C	0100-86C



13
15 cm
0100-13
lower premolars



18
17 cm
0100-18
upper molars
left

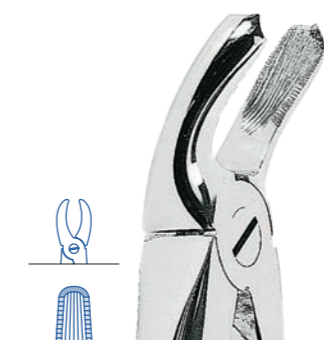

20
14 cm
0100-20
lower third molars

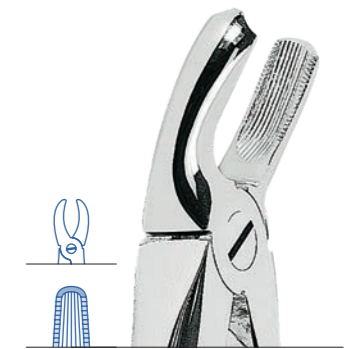

17
17 cm
0100-17
upper molars
right



18A
17 cm
0100-18A
upper molars



21
16 cm
0100-21
lower molars

Extracting forceps

serrated tips



19
17 cm
0100-19
upper third molars



22
15 cm
0100-22
lower molars



22L Routurier
18 cm
0100-22L
lower molars and
third molars, left



22R Routurier
18 cm
0100-22R
lower molars and
third molars, right



23
0100-23
15 cm
lower molars
right



24
15 cm
0100-24
lower molars
left

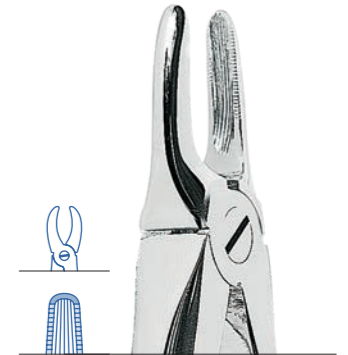

29
17 cm
0100-29
upper roots

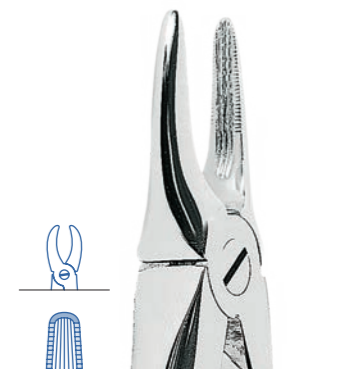

29N
17 cm
0100-29N
upper roots
and incisors

Extracting forceps

serrated tips

Extracting forceps

serrated tips



0100-45
Curved extracting forceps for lower roots.



30
17 cm
0100-30
upper roots



31
16 cm
0100-31
lower roots
and incisors



33
15 cm
0100-33
lower roots



33A
15 cm
0100-33A
lower roots



33L
15 cm
0100-33L
lower roots



38A
15 cm
0100-38A
fractured or decayed
lower teeth



41
19 cm
0100-41
upper roots



43A
17 cm
0100-43A
fractured or decayed
upper teeth



44
19 cm
0100-44
upper roots



46
18 cm
0100-46
lower roots



45
18 cm
0100-45
lower roots



46L
18 cm
0100-46L
lower roots

Extracting forceps

serrated tips



48
19 cm
0100-48
upper roots



49
19 cm
0100-49
upper roots



51
18 cm
0100-51
upper roots

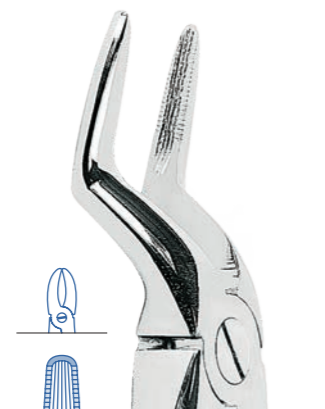

51A
18 cm
0100-51A
upper roots



51L
19 cm
0100-51L
upper roots

Extracting forceps

serrated tips



51LX
20 cm
0100-51LX
upper roots



52
18 cm
0100-52
upper roots
and canines

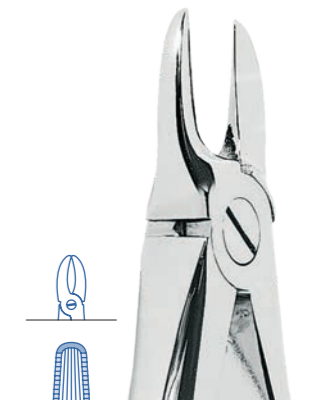

54
17 cm
0100-54
for separating
upper molars



55
17 cm
0100-55
for separating
upper molars



56
16 cm
0100-56
for separating
lower molars



59
15 cm
0100-59
lower roots



59L
16 cm
0100-59L
lower incisor roots

Extracting forceps

serrated tips

Extracting forceps

serrated tips



60
15 cm
0100-60
lower roots



65L
17 cm
0100-65L
upper molars
left



65R
17 cm
0100-65R
upper molars
right



66L
17 cm
0100-66L
upper molars
left



66R
17 cm
0100-66R
upper molars
right



67
18 cm
0100-67
upper third molars



67A
19 cm
0100-67A
upper third molars



67 1/2 L
18 cm
0100-67/L
upper third molars
left



67 1/2 R
18 cm
0100-67/R
lower incisor roots

Extracting forceps

serrated tips



68
18 cm
0100-68
lower roots



73
16 cm
0100-73
lower molars



74
16 cm
0100-74
lower roots



74M
15 cm
0100-74M
lower roots



74N
16 cm
0100-74N
lower roots

Extracting forceps

serrated tips



75
16 cm
0100-75
lower canines
and premolars



79
17 cm
0100-79
lower third molars



79A
17 cm
0100-79A
lower third molars



79C
17 cm
0100-79C
lower third molars

Extracting forceps

non-serrated tips

Extracting forceps

non-serrated tips



86 1/2L Roururier
17 cm
0100-86/L
lower third molars
left



86 1/2R Roururier
17 cm
0100-86/R
lower third molars
right



86C
16 cm
0100-86C
lower molars



86W White
17 cm
0100-86W
for lower last molar



87
16 cm
0100-87
lower decayed molars
or broken crowns



166 Trotter
17 cm
0100-166
universal extracting forceps
for upper teeth, in particular
molars and premolars

Extracting forceps

serrated tips



89
18 cm
0100-89
upper molars
right



90
18 cm
0100-90
upper molars
left



99
16 cm
0100-99
lower molars with
broken crowns



107
17 cm
0100-107
upper canines

Extracting forceps

serrated tips



121 Ogden-Felsch
18 cm
0100-121
upper third molars



145
18 cm
0100-145
lower roots



151 1/2
19 cm
0100-151/
upper roots

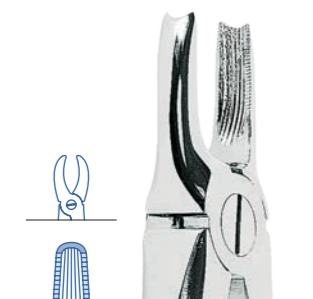

168 Trotter
17 cm
0100-168
upper canines



346
18 cm
0100-346
lower roots

Extracting forceps

non-serrated tips

serrated tips

serrated tips

Extracting forceps - AsaLady

serrated tips



167 Trotter
16 cm
0100-167
universal extracting forceps
for lower teeth, in particular
molars and premolars



169 Trotter
16 cm
0100-169
upper third molars



359
16 cm
0100-359
lower roots



349
19 cm
0100-349
upper roots



1
15 cm
W0160-1
upper incisors
and canines



2
16 cm
W0160-2
upper incisors
and canines



4
14 cm
W0160-4
lower incisors
and canines



7
15 cm
W0160-7
upper incisors
upper premolars



13
13 cm
W0160-13
lower premolars



17
15 cm
W0160-17
upper molars
right



18
15 cm
W0160-18
upper molars
left

Extracting forceps - AsaLady

serrated tips

Extracting forceps - AsaLady

serrated tips

non-serrated tips



22
13 cm
W0160-22
lower molars



33
13 cm
W0160-33
lower roots



W0160-51A
Angled extracting forceps for upper roots.



21
14 cm
W0160-21
lower molars



45
16 cm
W0160-45
lower roots



51A
17 cm
W0160-51A
upper roots



79
15 cm
W0160-79
lower third molars



145
16 cm
W0160-145
lower roots



86C
14 cm
W0160-86C
lower molars



67A
17 cm
W0160-67A
upper third molars

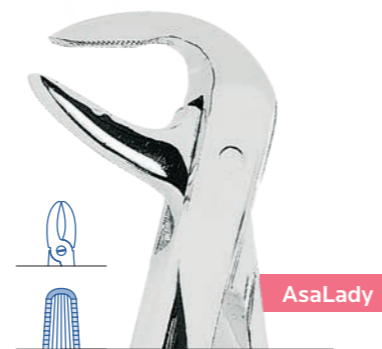

74
14 cm
W0160-74
lower roots



151 1/2
18 cm
W0160-151/
upper roots

Extracting forceps - MEAD pattern

serrated tips



1
17 cm
0104-1
universal extracting
forcep for upper
incisors and canines



2
17 cm
0104-2
upper molars

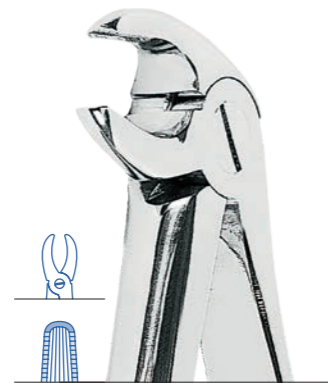

3
15 cm
0104-3
lower incisors,
premolars and roots

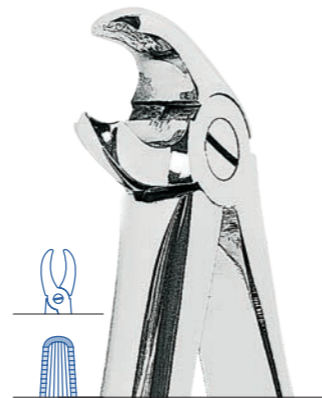

4
15 cm
0104-4
lower molars

0104-1



Extracting forceps - AMERICAN pattern

non-serrated tips



5 Physick
18 cm
0120-5
lower third molars



6
17 cm
0120-6
separating forceps



10S
18 cm
0120-10S
upper molars



16
17 cm
0120-16
lower molars



17
18 cm
0120-17
lower molars

Extracting forceps - AMERICAN pattern

non-serrated tips

Extracting forceps - AMERICAN pattern

non-serrated tips



18L Harris
18 cm
0120-18L
upper molars
left



18R Harris
18 cm
0120-18R
upper molars
right



23
18 cm
0120-23
lower molars



53R
19 cm
0120-53R
upper molars
right



53L
19 cm
0120-53L
upper molars
left



65
19 cm
0120-65
upper incisors
and roots



69 Tomes
18 cm
0120-69
upper and
lower roots



88L Nevius
18 cm
0120-88L
upper molars
left



88R Nevius
18 cm
0120-88R
upper molars
right



101 Hull
16 cm
0120-101
deciduous teeth

Extracting forceps - AMERICAN pattern

non-serrated tips



150 Cryer
18 cm
0120-150
upper incisors,
premolars, roots



150S Cryer
16 cm
0120-150S
upper teeth
(for children)



151 Cryer
17 cm
0120-151
lower incisors,
premolars, roots



151S Cryer
15 cm
0120-151S
lower teeth
(for children)



222
18 cm
0120-222
lower third molars

Extracting forceps - AMERICAN pattern, AsaLady

non-serrated tips



5 Physick
16 cm
W0121-5
lower third molars



6
16 cm
W0121-6
separating forceps



10S
17 cm
W0121-10S
upper molars

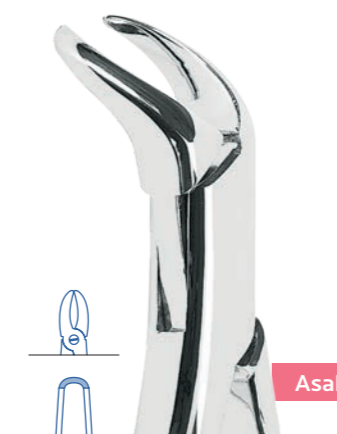

16
16 cm
W0121-16
lower molars



17
16 cm
W0121-17
lower molars

W0121-5

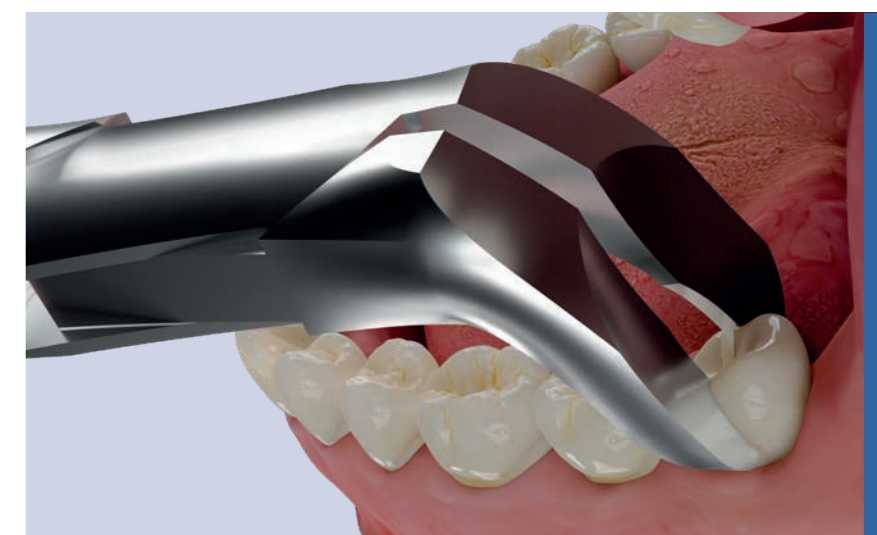

Extracting forceps - AMERICAN pattern, AsaLady

non-serrated tips

Extracting forceps - AMERICAN pattern, AsaLady

non-serrated tips



18L Harris
16 cm
W0121-18L
upper molars
left

AsaLady



18R Harris
16 cm
W0121-18R
upper molars
right

AsaLady



23
16 cm
W0121-23
lower molars

AsaLady



53R
17 cm
W0121-53R
upper molars
right

AsaLady



53L
17 cm
W0121-53L
upper molars
left

AsaLady



65
18 cm
W0121-65
upper incisors
and roots

AsaLady



69 Tomes
18 cm
W0121-69
upper and
lower roots

AsaLady



88L Nevius
17 cm
W0121-88L
upper molars
left

AsaLady



88R Nevius
17 cm
W0121-88R
upper molars
right

AsaLady



101 Hull
W0121-101
deciduous teeth

AsaLady

Extracting forceps - AMERICAN pattern, AsaLady

non-serrated tips

Extracting forceps - ANATOMICALLY SHAPED handle

serrated tips



AsaLady

150 Cryer
17 cm
W0121-150
upper incisors,
premolars, roots



AsaLady

150S Cryer
W0121-150S
upper teeth
(for children)



AsaLady

151 Cryer
16 cm
W0121-151
lower incisors,
premolars, roots



AsaLady

151S Cryer
W0121-151S
lower teeth
(for children)



AsaLady

222
17 cm
W0121-222
lower third molars



1
17 cm
0130-1
upper incisors
and canines

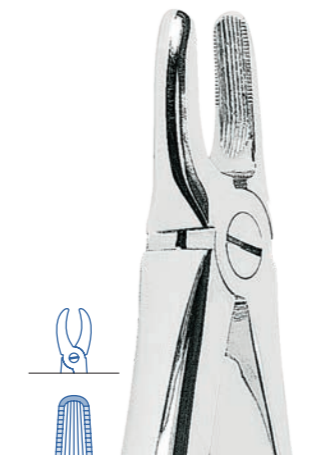

2
17 cm
0130-2
upper incisors
and canines



4
16 cm
0130-4
lower incisors
and canines

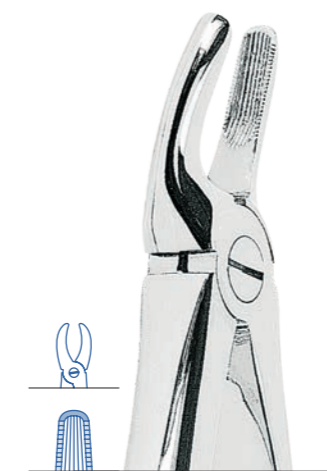

7
16 cm
0130-7
upper premolars



13
15 cm
0130-13
lower premolars

Extracting forceps - ANATOMICALLY SHAPED handle

serrated tips

Extracting forceps - ANATOMICALLY SHAPED handle

serrated tips



17
17 cm
0130-17
upper molars
right



18
17 cm
0130-18
upper molars
left



21
17 cm
0130-21
lower molars

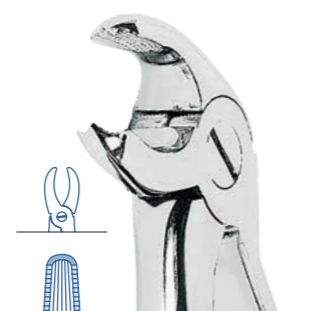

22
15 cm
0130-22
lower molars



33
15 cm
0130-33
lower roots

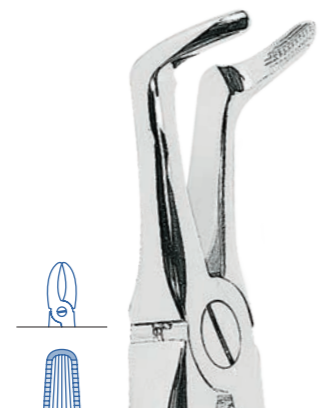

45
18 cm
0130-45
lower roots



51A
18 cm
0130-51A
upper roots



67A
18 cm
0130-67A
upper third molars



74
16 cm
0130-74
lower roots



79
17 cm
0130-79
lower third molars



86C
15 cm
0130-86C
lower molars

Extracting forceps - ANATOMICALLY SHAPED handle

serrated tips



89
17 cm
0130-89
upper molars
right



90
17 cm
0130-90
upper molars
left



145
18 cm
0130-145
lower roots



151 1/2
19 cm
0130-151/
upper roots



349
18 cm
0130-349
upper roots



359
16 cm
0130-359
lower roots

Extracting forceps for children

serrated tips



13S
13 cm
0110-13S
lower premolars



22S
14 cm
0110-22S
lower molars



30S
15 cm
0110-30S
upper incisors
and roots

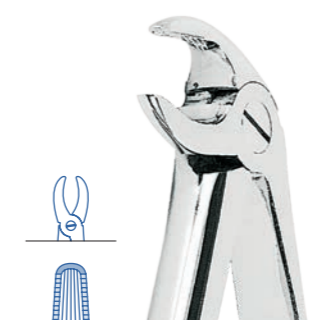

33S
14 cm
0110-33S
lower roots

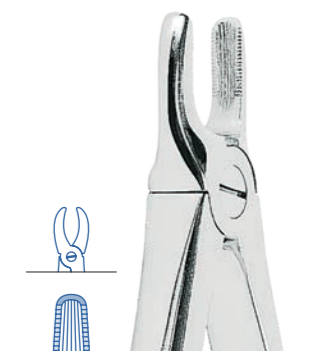

37
15 cm
0110-37
upper incisors,
premolars, roots

Extracting forceps for children

serrated tips



S0110

37	0110-37
39	0110-39
39R	0110-39R
39L	0110-39L
51S	0110-51S
13S	0110-13S
30S	0110-30S
33S	0110-33S
22S	0110-22S
38	0110-38



38
14 cm
0110-38
lower incisors
and canines



39
15 cm
0110-39
upper molars

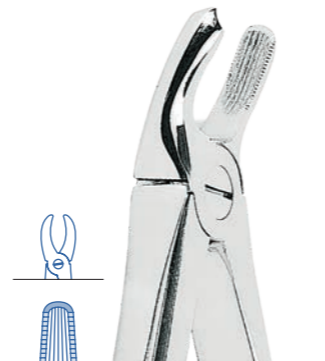

39R
15 cm
0110-39R
upper molars
right



39L
15 cm
0110-39L
upper molars
left



51S
16 cm
0110-51S
upper roots

Extracting forceps for children - KLEIN pattern

serrated tips



S0112

1	0112-1	5	0112-5
2	0112-2	6	0112-6
3	0112-3	7	0112-7
4	0112-4		



2
13 cm
0112-2
upper premolars

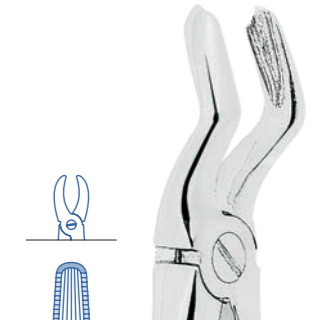

3
13 cm
0112-3
upper molars



1
12 cm
0112-1
upper incisors



4
13 cm
0112-4
upper roots



5
11 cm
0112-5
lower incisors

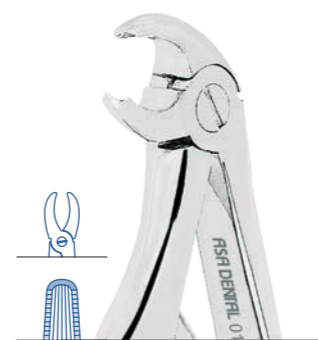

6
11 cm
0112-6
lower molars



7
11 cm
0112-7
lower roots

Extracting forceps for roots

serrated tips



0101-1
Witzel extracting forceps are pliers handle versatile instruments that can be used for extraction of both teeth and roots. The serrated tips, the curved jaw and the slim profile make them effective on roots, preventing unwanted fractures.

Extracting forceps for root splinters

non-serrated tips



0102-1
This forceps are designed for precision and sensitivity. The scissor-like handle increases guidance while the narrow beak allows reaching and firmly holding small root fragments.



1 Witzel
15 cm
0101-1
lower roots



2 Witzel
15 cm
0101-2
upper roots



1 Stieglitz
14 cm
0102-1
root fragments



2 Stieglitz
13 cm
0102-2
root fragments

Bone rongeurs

Bone rongeurs



Luer
15 cm
0103-10



Friedman
14 cm
0103-20



Mini Friedman
12 cm
0103-25



Cleveland 5
16 cm
0103-40



Cleveland-Gardner
16 cm
0103-45



Blumenthal
15 cm
0103-30



Blumenthal
14 cm
0103-31



Blumenthal
14 cm
0103-32



Mead 1A
16 cm
0103-50

Bone rongeurs

multiple action

Bone/soft tissue nipper

small size for use
in limited access areas

Root elevators with stainless steel handle



0234-1



Mini-Ruskin
15 cm
0103-70



Beyer
17 cm
0103-71



Goldman-Fox
10 cm
0103-60



1 Hylin
0234-1



2 Hylin
0234-2



3 Hylin
0234-3



4 Hylin
0234-4

Root elevators with stainless steel handle



0231-2



Root elevators with stainless steel handle



1B	0200-1
4B	0200-4
2F	0201-2
3F	0201-3
44	0220-44
45	0220-45

S0200-6



Root elevators with stainless steel handle



Root elevators with stainless steel handle



S0200-10

2B	0200-2
3B	0200-3
4B	0200-4
2F	0201-2
3F	0201-3
1	0291-1
2	0291-2
3	0291-3
320	0202-320
321	0202-321



Root elevators with stainless steel handle

helicoidal tips



S0244-6

1K	0244-1
2K	0244-2
3K	0244-3
4K	0244-4
5K	0244-5
6K	0244-6

Root elevators with stainless steel handle

helicoidal tips



Root elevators with stainless steel handle



Root elevators with stainless steel handle



Root elevators with stainless steel handle

Root elevators with stainless steel handle



Root elevators with stainless steel handle



Root elevators with stainless steel handle

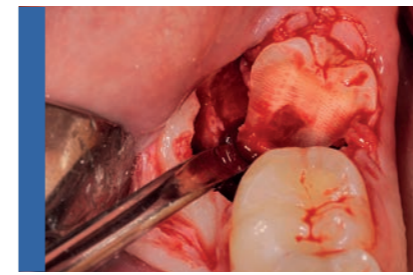

0229-1F
Almost all impacted lower third molars can be handled with this Friedman elevator that, applied from above in the gap produced by bone resection, dislocates the tooth upward and backward. Third molar cut and removal of fragment with the Friedman elevator (double mirror + Friedman)

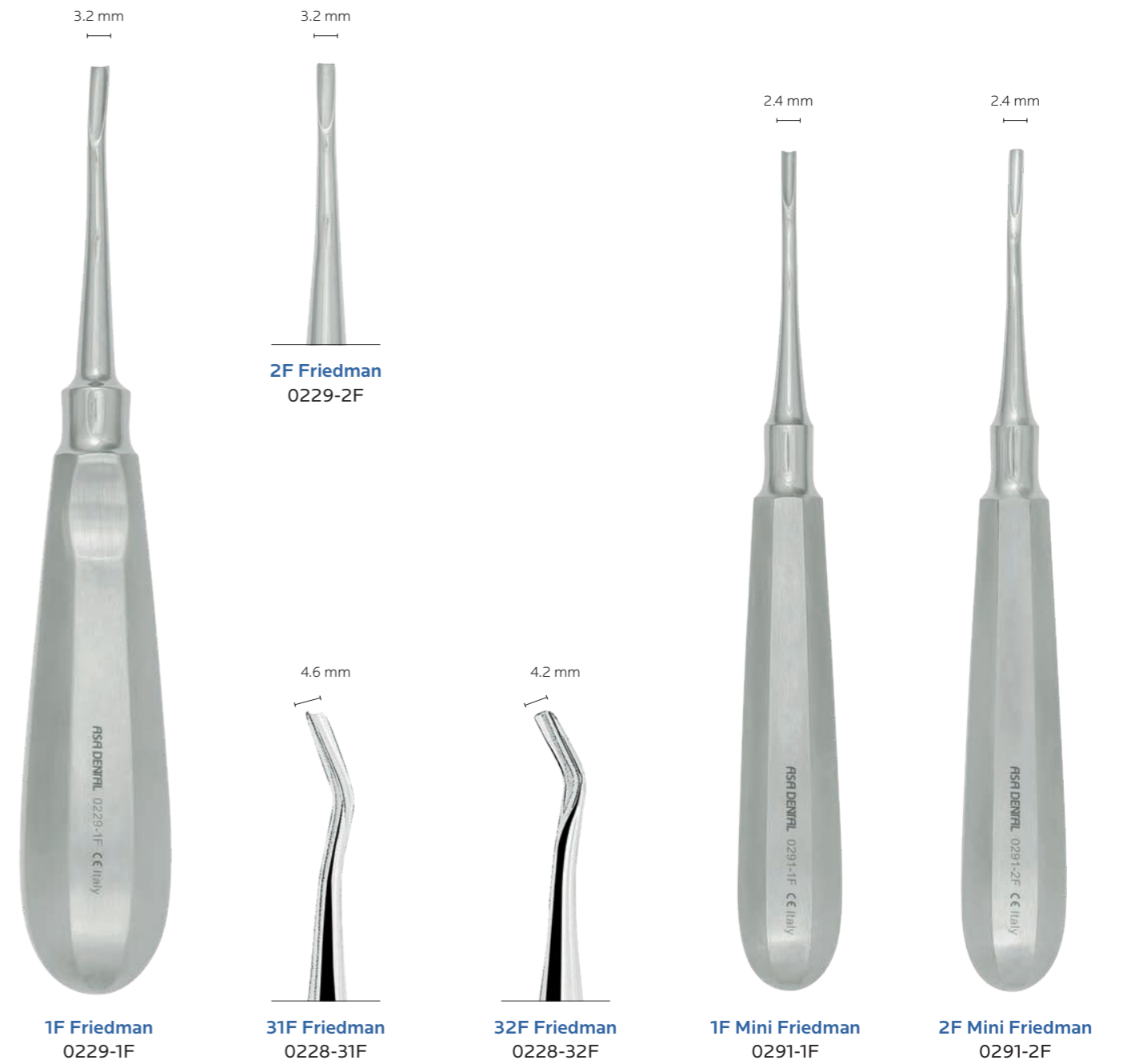

Root elevators with stainless steel handle

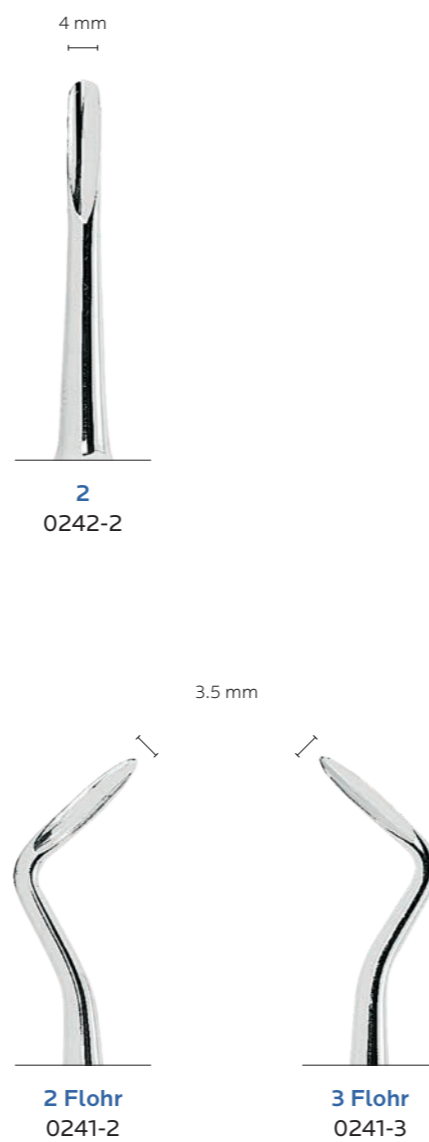

Root elevators with stainless steel ANATOMICALLY SHAPED handle

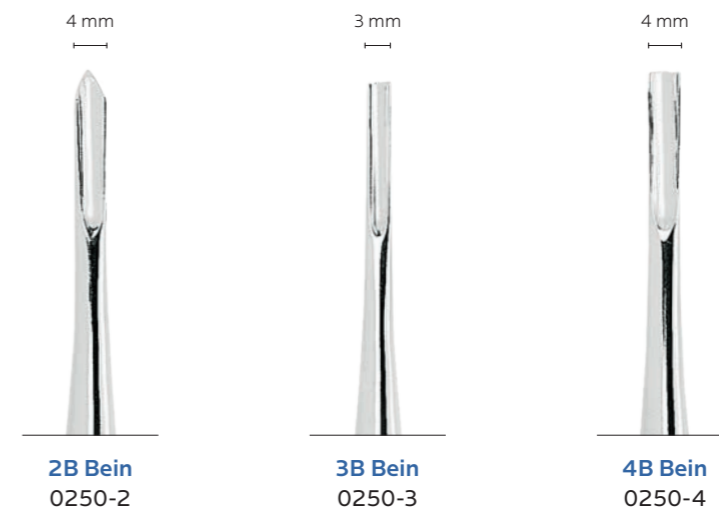

Root elevators with stainless steel ANATOMICALLY SHAPED handle



Root elevators with stainless steel handle

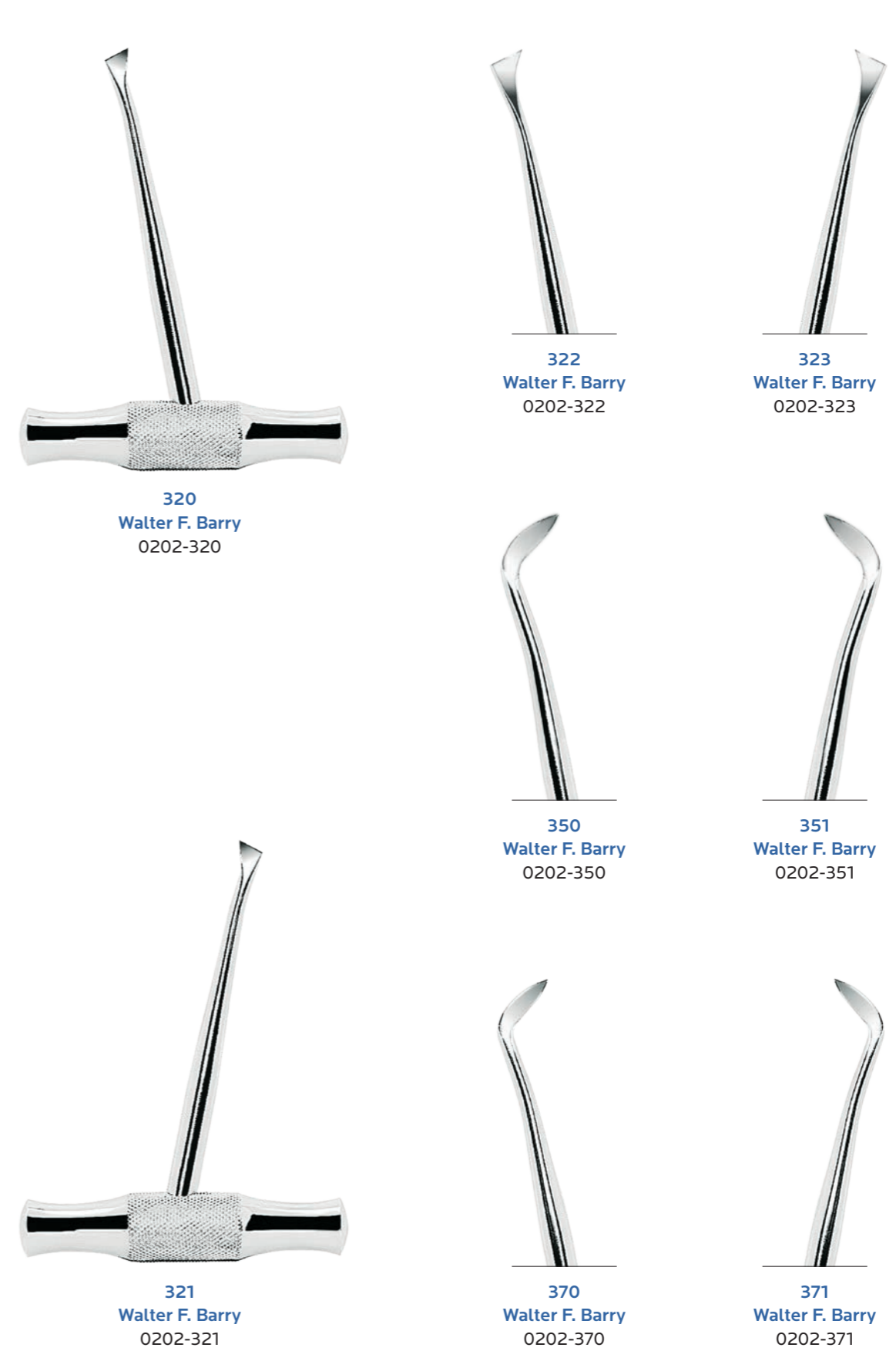

Root elevators with stainless steel handle



Root elevators with stainless steel handle



Root-tip picks with stainless steel handle



Root-tip picks with stainless steel handle

Syndesmotomes with stainless steel handle



1 Heidbrink
0290-1



2 Heidbrink
0290-2



3 Heidbrink
0290-3

2.8 mm



1 Warwick-James
0294-1

2 mm



2 Warwick-James
0294-2

2 mm



3 Warwick-James
0294-3



1 Chompret
0295-1



2 Chompret
0295-2



4 Chompret
0295-4



3 Chompret
0295-3



3 Chompret
W0298-3

AsaLady

Syndesmotomes

Syndesmotomes



11 cm
0296-M



0
0296-0

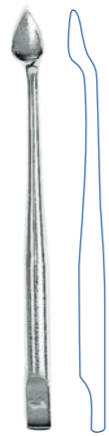

1
0296-1



2
0296-2



3
0296-3



4
0296-4



5
0296-5



6
0296-6



7
0296-7



8
0296-8



9
0296-9

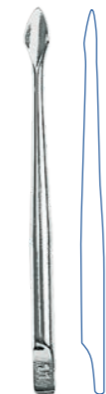

11
0296-11

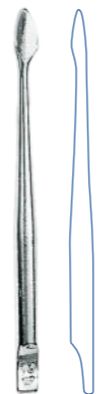

21
0296-21

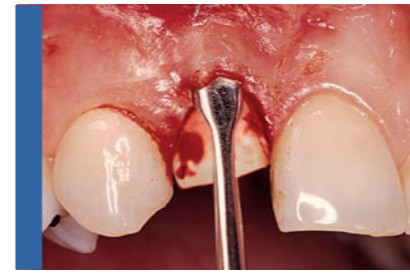

0296-22
Asa Dental syndesmotomes offer the advantage of one handle and many easy to replace tips, helping solve the clinical case at hand. Usually very effective to prepare the field for atraumatic extraction, many of them can be conveniently used as periostomes.



22
0296-22



23
0296-23



24
0296-24



25
0296-25



26
0296-26



27
0296-27



28
0296-28



29
0296-29

Exciser



PR1857-1
Used immediately following scalpel incision, it facilitates surgical incision and net release of the periosteal in bone exposure



PR1857-1
Perfection

Periotomes



1
ML1845-1



2
ML1845-2



3
ML1845-3

Syndesmotomes instruments kit

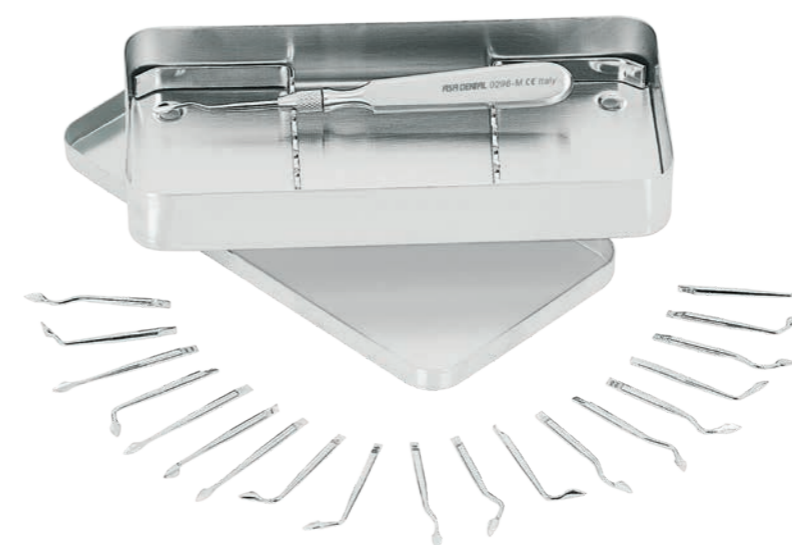

S0296

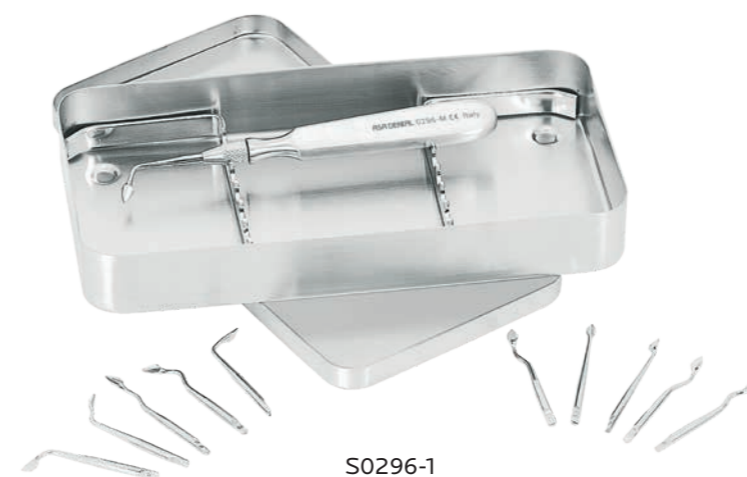

S0296-1



0297-1

	syndesmotome handle	0296-M
0	syndesmotome tip	0296-0
1	syndesmotome tip	0296-1
2	syndesmotome tip	0296-2
3	syndesmotome tip	0296-3
4	syndesmotome tip	0296-4
5	syndesmotome tip	0296-5
6	syndesmotome tip	0296-6
7	syndesmotome tip	0296-7
8	syndesmotome tip	0296-8
9	syndesmotome tip	0296-9
11	syndesmotome tip	0296-11
21	syndesmotome tip	0296-21
22	syndesmotome tip	0296-22
23	syndesmotome tip	0296-23
24	syndesmotome tip	0296-24
25	syndesmotome tip	0296-25
26	syndesmotome tip	0296-26
27	syndesmotome tip	0296-27
28	syndesmotome tip	0296-28
29	syndesmotome tip	0296-29
	insert frame tray	2700-G
	base tray	2700-L
	lid tray	2700-U

	syndesmotome handle	0296-M
0	syndesmotome tip	0296-0
1	syndesmotome tip	0296-1
2	syndesmotome tip	0296-2
3	syndesmotome tip	0296-3
4	syndesmotome tip	0296-4
5	syndesmotome tip	0296-5
6	syndesmotome tip	0296-6
7	syndesmotome tip	0296-7
8	syndesmotome tip	0296-8
9	syndesmotome tip	0296-9
11	syndesmotome tip	0296-11
	insert frame tray	2700-G
	base tray	2700-L
	lid tray	2700-U

syndesmotome tips holder
20 holes
70x40x12 mm

Extraction and oral surgery kit



Oral surgery kit
SPR2781-S

	mouth mirror handle	ML2101
5	double sided mouth mirrors	22305
CP-15	periodontal pocket probes	0702L-15
5	scalpel handle and blade	0350-5
	exciser	PR1857-1
PR3	Prichard periosteal tissue pliers	MV1851-PR3 PR0625-2
23	Seldin retractor	1855-23
	Farabeuf retractor	2616-1
	Friedman root elevator	0229-2F
	Friedman root elevator	0229-1F
	Mini Friedman root elevator	0291-1F
	Mini Friedman root elevator	0291-2F
85	Lucas bone curette	ML2001-85
87	Lucas bone curette	ML2001-87
88	Lucas bone curette	ML2001-88
2R/2L	periodontal instrument	ML1806-2RL
4R/4L	periodontal instrument	ML1806-4RL
	Castroviejo needle holder	PR0460-15TC
2TC	gum scissors	0309-2TC
	sterilization cassette	2780-1B



S0100-3

33	extracting forcep	0100-33
51A	extracting forcep	0100-51A
67A	extracting forcep	0100-67A
79	extracting forcep	0100-79
1B	root elevator	0200-1
2F	root elevator	0201-2
3F	root elevator	0201-3
320	root elevator	0202-320
321	root elevator	0202-321



S0100-4

33	extracting forcep	0100-33
51A	extracting forcep	0100-51A
67A	extracting forcep	0100-67A
79	extracting forcep	0100-79
1B	root elevator	0200-1
2B	root elevator	0201-2
3B	root elevator	0201-3
	needle holders	0435-14TC
	needle holders	0425-16TC

Accessories

case for instruments and pliers



9002

1	case	9002
2	insert with elastic bands for 10 instruments	9002-2
3	insert with slots for 16 instruments	9002-3
4	insert for 6 extractive forceps	9002-1

autoclave instrument protection lubricant

Best instruments' autoclaving protection. Penetrates and lubricates all instruments' joints. Protects all dental and surgical hand instruments before and after sterilization. Instructions for use: oil all tips, joints and fastening of instruments before and after sterilization.



Steril Oil
40 ml
8002

Specific lubricant for dental and surgical instruments. The lubricant is designed to lubricate joints of all dental instruments (scissors, haemostatic and extracting forceps, bone rongeurs, needle holders etc.). Before and after sterilization it does not dry out during sterilization. Provides protection from corrosion and other deposits and ensures proper operation of the instruments.



Silicone
40 ml
8010

IMPLANT SURGERY

MADE IN ITALY

FROM LOSS TO RECOVERY

In the last decade, implantology has become an important part of clinical practice, helping dentists to improve the quality of life of many patients. Whilst implant treatment could often be a convenient alternative to conventional treatment options, in certain cases, it is the treatment of first choice for the rehabilitation of severe functional, anatomical or aesthetic problems arising from tooth loss. Asa Dental has developed a number of highly functional and easy to use instruments to help qualified dentists tackle even the most challenging clinical cases effectively and fully deliver all the advantages patients can benefit from Implant Surgery, including high stability, preservation of alveolar bone and long-term results. Our proficiency with design and manufacturing has led to educational collaboration with major dental institutions to grow competency in this branch of dentistry among dental professionals.

- E4 Scissors
- E5 Needle holders
- E7 Scalpels
- E10 Retractors
- E13 Sinus lift instruments
- E16 Mallets
- E16 Chisels
- E18 Osteotomes
- E21 Bone instruments and accessories
- E32 Pocket probes
- E32 Depth gauges
- E33 Aspirators
- E33 Calipers
- E34 Burs
- E35 Bone compactors
- E35 Pocket markers
- E36 Tissue pliers
- E37 Tweezers
- E38 Kits

Handle options

SINGLE END

Asa60
(stainless steel)
ø 6.0 mm

Leonardo ML
(stainless steel)
ø 7.0 mm

Perfection
(stainless steel)
ø 8.0 mm

● Magic Color MC
(aluminum core and
non-slip plastic)
ø 8.0 / 10.5 mm

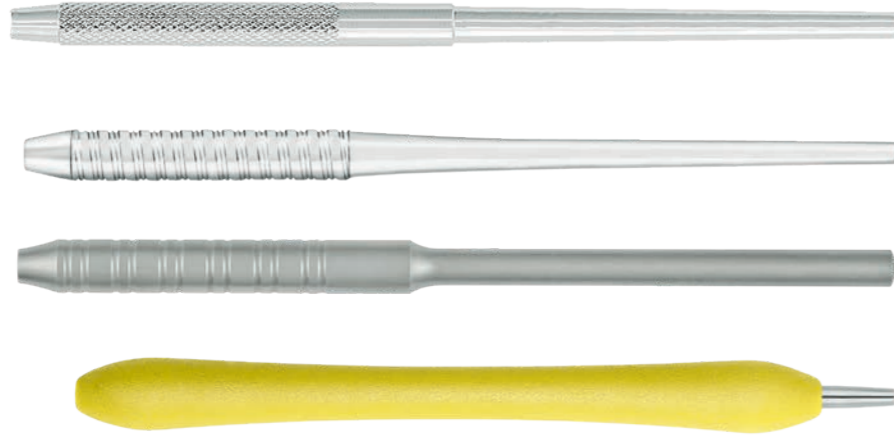

DOUBLE END

Asa60
(stainless steel)
ø 6.0 mm

Asa Light MV
(stainless steel, hollow)
ø 8.0 mm

Leonardo ML
(stainless steel)
ø 7.0 mm

Perfection
(stainless steel)
ø 8.0 mm

Octagonal
(stainless steel)
ø 5.5 mm

● Magic Color MC
(aluminum core and
non-slip plastic)
ø 8.0 / 10.5 mm

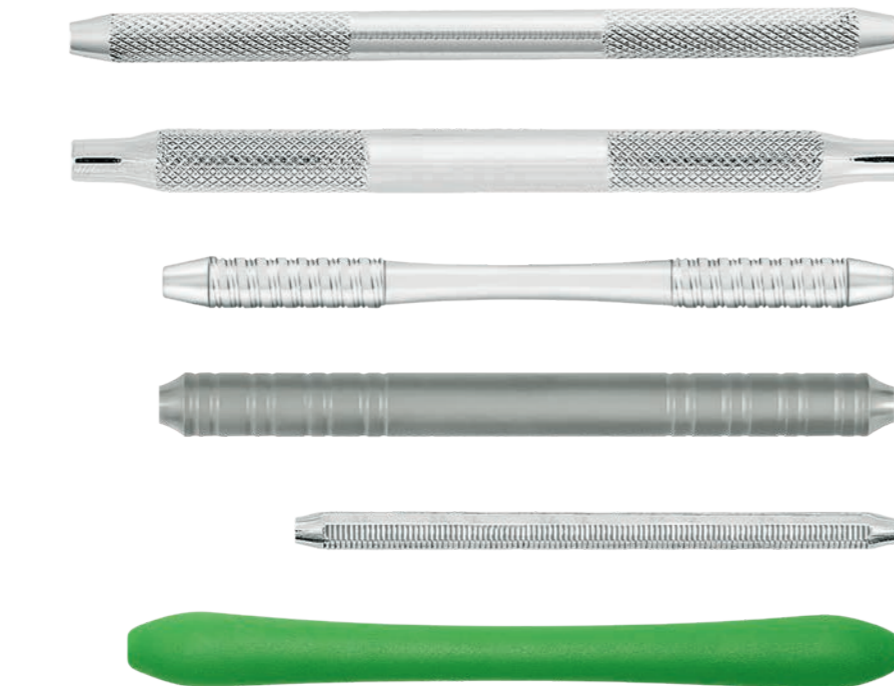

standard instrument



instrument with tungsten carbide (TC) inserts

How to use

- CP-12 → pattern + scientific name
- MC0702-12 → Asa Dental code
- Magic Color MC → handle option

AsaLady

products ergonomically designed for women hands:

- smaller and lighter handles
- smaller finger holes
- reduced size
- code starts with "W" or "SW"

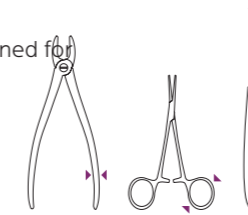

* these products are not manufactured by Asa Dental and are distributed under manufacturer brand

Gum scissors



1 Goldman-Fox
straight
one blade serrated
13 cm
0304-1



2 Goldman-Fox
curved
one blade serrated
13 cm
0304-2



1TC Kelly
straight
16 cm
0309-1TC



2TC Kelly
curved
16 cm
0309-2TC



1 Metzenbaum-Delikat
straight
14.5 cm
0322-1



2 Metzenbaum-Delikat
curved
14.5 cm
0322-2

dissecting scissors

Needle holders



TC Mathieu
14 cm
0435-14TC



TC Mathieu
17 cm
0435-17TC



TC Lichtenberg
17 cm
0437-17TC



TC Castroviejo
14 cm
0445-14TC



TC Castroviejo
14 cm
0446-14TC



TC Castroviejo
14 cm / 60°
0448-14TC

Needle holders

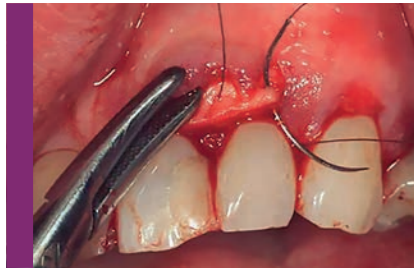

PR0460-15TC
CURVED CASTROVIEJO NEEDLE HOLDER
Allows maximum ease of handling during suturing.

Scalpel handles



TC Castroviejo
with curved jaws
15.5 cm
PR0460-15TC



TC Micro-Barraquer
18 cm
0450-18TC



TC Micro-Barraquer
with curved jaws
18 cm
0451-18TC



3
13 cm
0350-3



3
12 cm
W0349-3

AsaLady



3G
13 cm
0350-3G



8
13 cm
0350-8



7
16 cm
0350-7

Scalpel handles



5
14.5 cm
0350-5

5A
14.5 cm
0350-5A

Scalpel blades *

100 pcs / box



12D
double cutting edge
0351-12D



15C
0351-15C



10
0351-10



11
0351-11



12
0351-12



15
0351-15

Micro-blades *

25 pcs (sterile) / box



13.5 cm
0365-1



7
0366-7



4
0366-4



7
0366-7

Orientable blade scalpel handle



16 cm
0335-1



16.5 cm
0352

Scalpel blade remover



16.5 cm
0352



kit of 0352 scalpel blade remover +
0335-1 orientable blade scalpel handle

Disposable scalpels *

100 pcs / box



0371-11



0371-10



0371-12



0371-15

Retractors

labial retractors



23.5 cm
2628-1

vestibular a-matic retractor



25.5 cm
2628-2

Retractors



20 cm
2627

lip retractors



Sternberg
14 cm
2602-1



Orringer medium
11 x 8 cm
2609-2

Retractors

cheek retractor

ramus retractors for nasal spine

Sinus lift instruments



University of Minnesota
14 cm
2604



Middeldorpf
21.5 cm
2620-1



21 cm
2625-1



21 cm
2626-1



1
MV1856-1
Asa Light MV

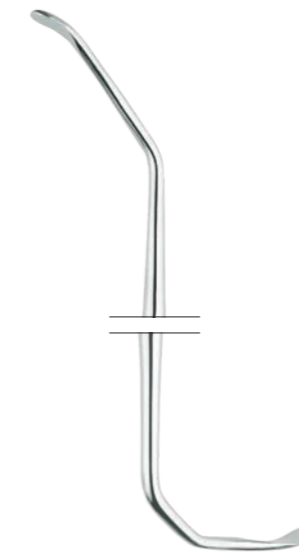

2
MV1856-2
Asa Light MV



3
MV1856-3
Asa Light MV



4
MV1856-4
Asa Light MV

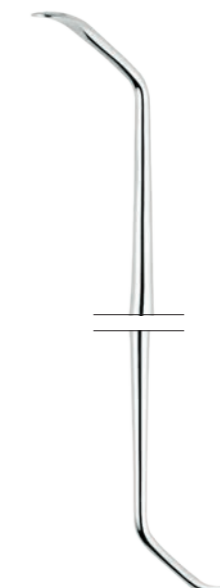

5
MV1856-5
Asa Light MV

Sinus lift instruments



6
MV1856-6
Asa Light MV



7
MV1856-7
Asa Light MV

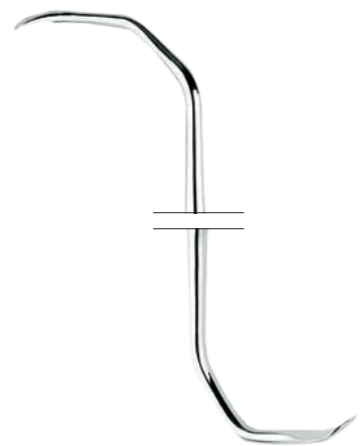

8
MV1856-8
Asa Light MV



1
PR1859-1
Perfection



2
PR1859-2
Perfection



1
MV1855-1
Asa Light MV



2
MV1855-2
Asa Light MV

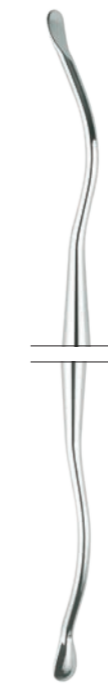

4
MV1855-4
Asa Light MV

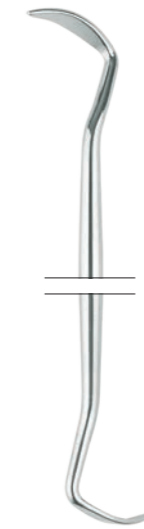

3
MV1855-3
Asa Light MV

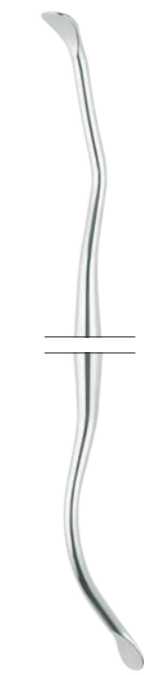

5
MV1855-5
Asa Light MV



6
MV1855-6
Asa Light MV

Sinus lift instruments

Mallets

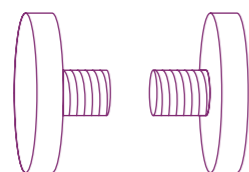

1881-R
#2 Teflon inserts
autoclavable
max 120°



Partsch
19 cm
1880
lead filled



Mead
19.5 cm
1881

Freer single cut chisels

2 mm



0.7 mm



1 Freer
1839-1

4 mm



1.3 mm



3 Freer
1839-3

6.3 mm



1.3 mm

Graduated chisels

3.8 mm

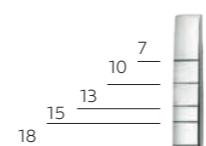

1
straight
1840-1

3.8 mm

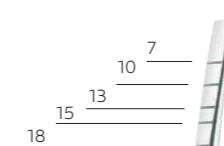

2
curved
1840-2

7.5 mm

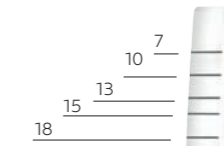

3
straight
1840-3

7.5 mm

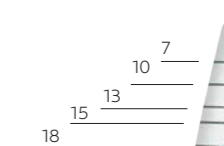

4
curved
1840-4

1840-1

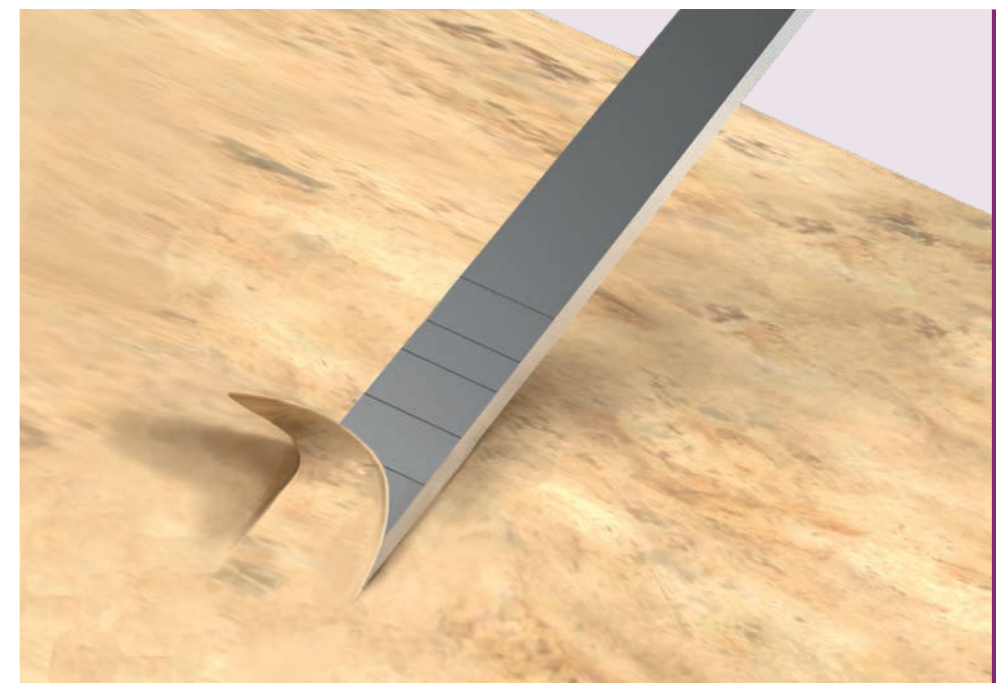

Osteotomes

Osteotomes

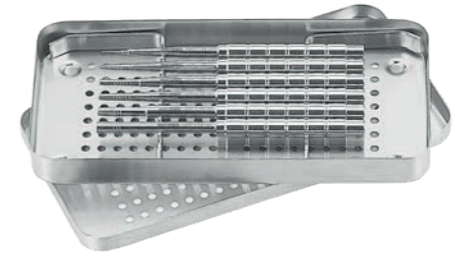

1 · 2 · 3 · 4 · 5 · 6
S0495-6
set of 6
with tray S2702

annular osteotomes with setting point

 CONCAVE Ø 3 mm 165 mm 0498-1B3	 CONCAVE Ø 3.3 mm 165 mm 0498-1B3	 CONCAVE Ø 3 mm 165 mm 0498-2C3	 CONCAVE Ø 3.3 mm 165 mm 0498-2C3	 ANGULAR Ø 3 mm 165 mm 0498-30B3	 FLAT Ø 3 mm 120 mm 0498-PF3
 CONCAVE Ø 3 mm 165 mm 0498-1B3	 CONCAVE Ø 3.3 mm 165 mm 0498-1B3	 CONCAVE Ø 3 mm 165 mm 0498-2C3	 CONCAVE Ø 3.3 mm 165 mm 0498-2C3	 ANGULAR Ø 3.3 mm 165 mm 0498-30B3	 FLAT Ø 3.3 mm 120 mm 0498-PF3
 CONCAVE Ø 4 mm 165 mm 0498-1B4	 CONCAVE Ø 4 mm 165 mm 0498-1B4	 CONCAVE Ø 4 mm 165 mm 0498-2C4	 CONCAVE Ø 4 mm 165 mm 0498-2C4	 ANGULAR Ø 4 mm 165 mm 0498-30B4	 FLAT Ø 4 mm 120 mm 0498-PF4
 CONCAVE Ø 5 mm 165 mm 0498-1B5	 CONCAVE Ø 5 mm 165 mm 0498-1B5	 CONCAVE Ø 5 mm 165 mm 0498-2C5	 CONCAVE Ø 5 mm 165 mm 0498-2C5	 ANGULAR Ø 5 mm 165 mm 0498-30B5	 FLAT Ø 5 mm 120 mm 0498-PF5

 CONCAVE Ø 1.5 mm 7.5 · Ø 1.6 mm 9 · Ø 1.7 mm 10.5 · Ø 2.2 mm 12 · Ø 2.4 mm 13.2 · Ø 2.5 mm 15.2 · Ø 3.4 mm 155 mm 0495-1	 CONCAVE Ø 1.8 mm 7.5 · Ø 2 mm 9 · Ø 2.1 mm 10.5 · Ø 2.9 mm 12 · Ø 3 mm 13.2 · Ø 3.1 mm 15.2 · Ø 3.2 mm 155 mm 0495-2	 CONCAVE Ø 2.9 mm 7.5 · Ø 3.1 mm 9 · Ø 3.2 mm 10.5 · Ø 3.3 mm 12 · Ø 3.4 mm 13.2 · Ø 3.4 mm 15.2 · Ø 3.5 mm 155 mm 0495-3	 CONCAVE Ø 3.1 mm 7.5 · Ø 3.8 mm 9 · Ø 3.9 mm 10.5 · Ø 4.1 mm 12 · Ø 4.2 mm 13.2 · Ø 4.3 mm 15.2 · Ø 4.6 mm 155 mm 0495-4	 CONCAVE Ø 4.1 mm 8.5 · Ø 5 mm 10 · Ø 5 mm 11 · Ø 5 mm 155 mm 0495-5	 CONCAVE Ø 5.5 mm 8.5 · Ø 6.2 mm 10 · Ø 6.2 mm 11 · Ø 6.2 mm 155 mm 0495-6
---	---	---	---	---	---

Osteotomes

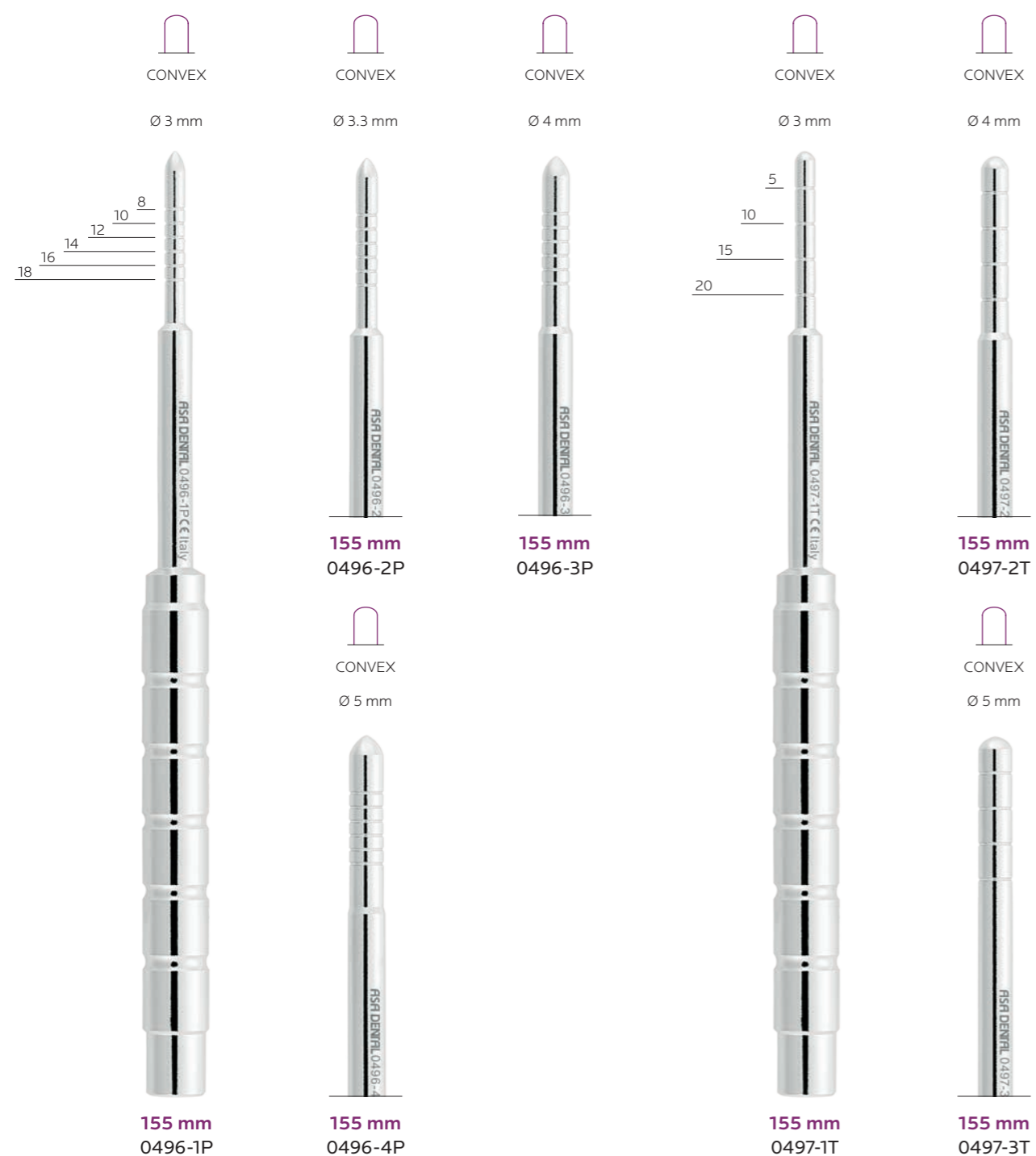

Bone files

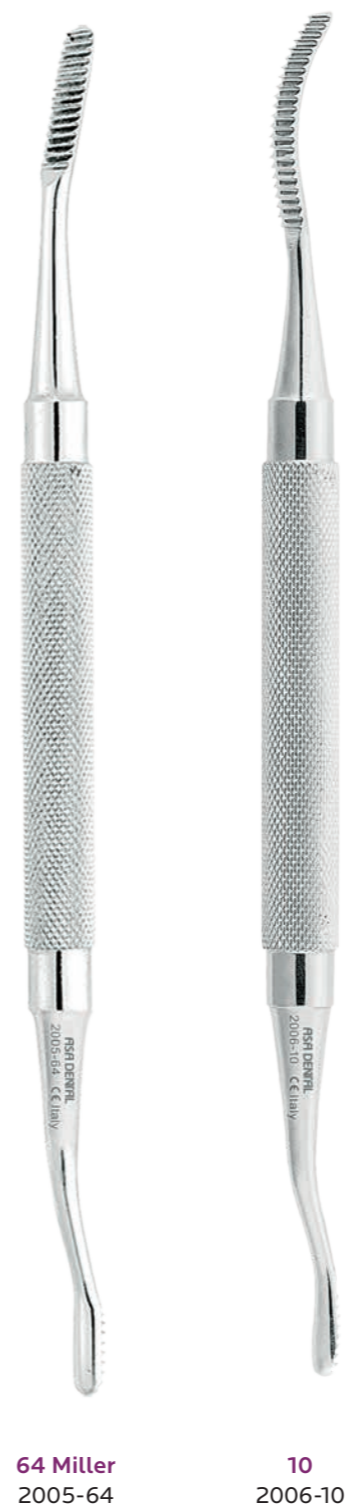

Bone cures



Exciser

Periosteal elevators

Periosteal elevators

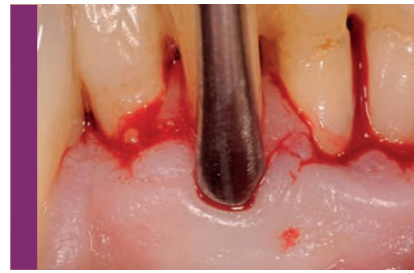

PR1850-M
 PERIOSTEAL ELEVATOR
 WITH ROUNDED TIP AND LANCE TIP
 Allows efficient release of even
 the most restricted and scalloped
 gingival margins.



1
 PR1857-1
 Perfection

3 mm
 LANCE TIP



3 mm
 ROUNDED TIP

Buser
 PR1850-M
 Perfection



Beale
 5114-1
 Octagonal



GF Goldman-Fox
 MV1850-GF
 Asa Light MV



9A Allen
 MV1850-9A
 Asa Light MV

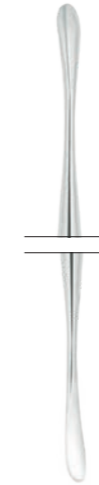

M7 Molt
 MV1850-M7
 Asa Light MV

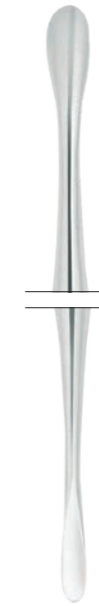

M8 Molt
 MV1850-M8
 Asa Light MV



M9 Molt
 MV1850-M9
 Asa Light MV

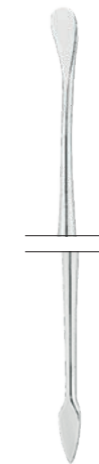

2 Hourigan
 MV1851-2
 Asa Light MV



PR3 Prichard
 MV1851-PR3
 Asa Light MV

Periosteal elevators



PR1850-1
PAPILLA PERIOSTEAL
for atraumatic release and
lifting of the gingival papilla
in papilla restorative
techniques.

2 mm

2.5 mm

Periosteal elevators



Partsch
14.5 cm
1849-1
Asa60

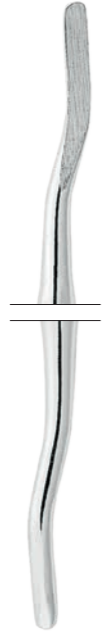

1 Hopkins
MV1852-1
Asa Light MV

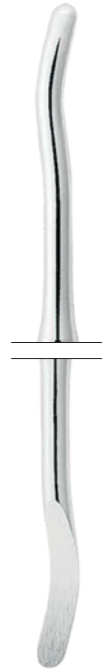

2 Hopkins
MV1852-2
Asa Light MV

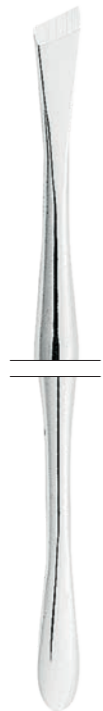

3 Mead
MV1854-3
Asa Light MV

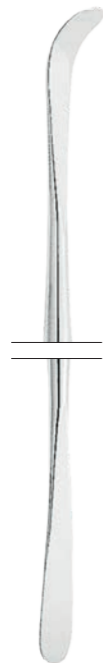

15 Freer
MV1853-15
Asa Light MV

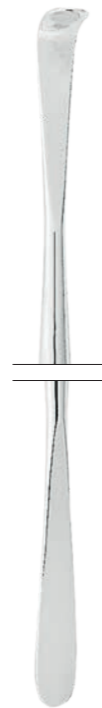

16 Freer
MV1853-16
Asa Light MV



17 cm
PR1850-1
Perfection



22 Seldin
retractor
1855-22



23 Seldin
retractor
1855-23



König
15.5 cm
1858-1



Williger
17 cm
1856-1



Williger
16 cm
1856-2



Williger
16 cm
1857-1



Williger
13 cm
1857-2

Mucotomes

3 mm



straight
1844-3

4 mm



straight
1844-4

5 mm



straight
1844-5

6 mm



straight
1844-6

3 mm



curved
1844-3C

4 mm



curved
1844-4C

5 mm



curved
1844-5C

6 mm



curved
1844-6C

Bone injector

Ø 2.5 mm



16 cm
0490-1

Ø 4.5 mm



16 cm
0490-2

Bone mill



17 cm
1846

Bone scrapers

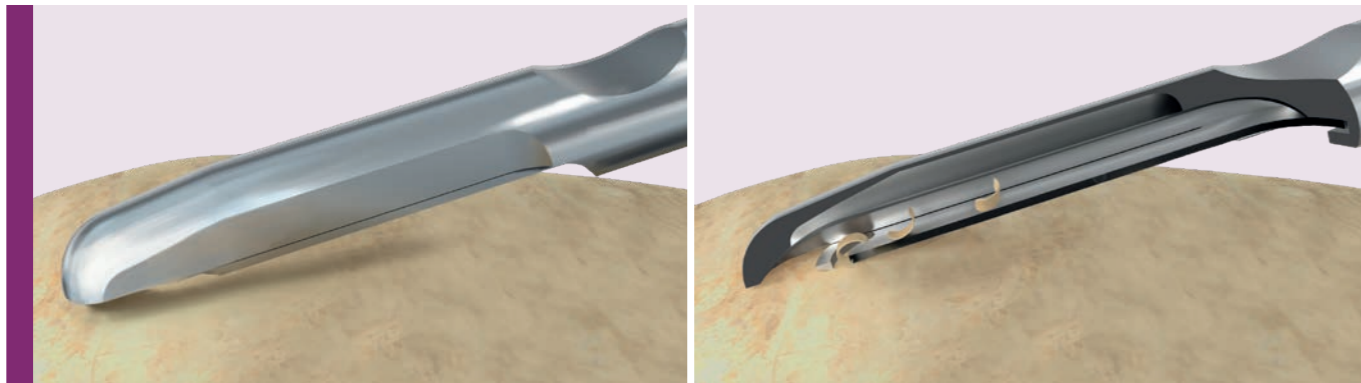

0494-1



straight
15 cm
0494-1
blade included



straight
0494-1R
blade for
0494-1



curved
15 cm
0494-2
blade included



straight
0494-2R
blade for
0494-2

Periotomes



1
ML1845-1
Leonardo ML

2
ML1845-2
Leonardo ML

3
ML1845-3
Leonardo ML

Bone applicator



MV1231-1
Asa Light MV

Bone/soft tissue nipper

small size for use
in limited access areas



Goldman-Fox
10 cm
0103-60

Bone rongeurs

Bone thickness gauge

Membrane placement instrument



Luer
15 cm
0103-10



Mini Friedman
12 cm
0103-25



Blumenthal
15 cm
0103-30



Blumenthal
14.5 cm
0103-31

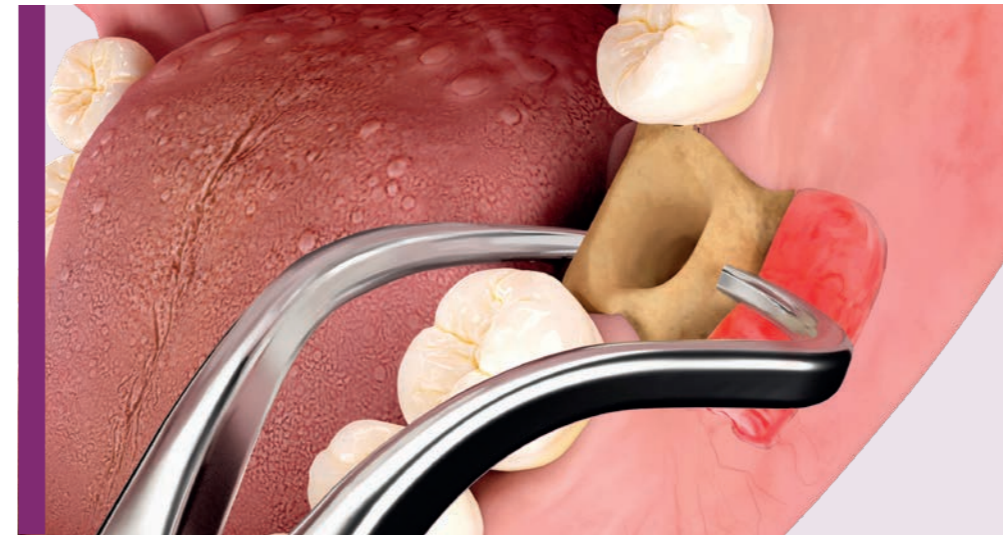

0491-2



17.5 cm
0491-1



15.5 cm
0491-2



Buser
MV1883
Asa Light MV

Bone well

Pocket probes

Depth gauge

Aspirators
bone filters

Caliper



h. 3 cm
1030-4



CP-11
0702L-11
Asa60



CP-12
0702L-12
Asa60
MC0702-12
● Magic Color MC



CP-12S
0702L-12S
Asa60



ML0804-1



surgical saliva ejector
bone filter
autoclavable

200 mm
16.5 cm
0493-1

spare filter
medium grid
for 0493-1



Ø 5 mm
2.7 cm
0493-2



stainless steel bone filter
to be used with the
disposable saliva ejector



0493-5

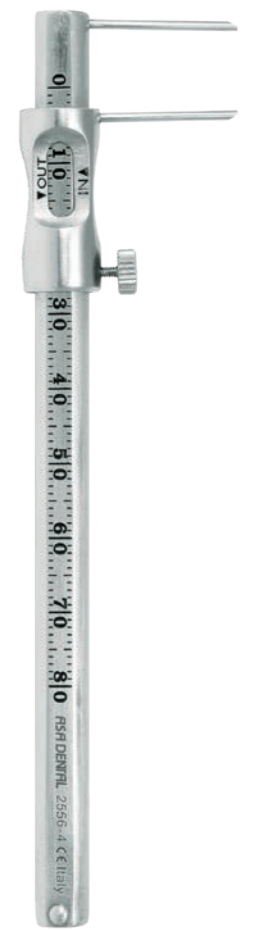

2556-4

Trepine graduated burs *

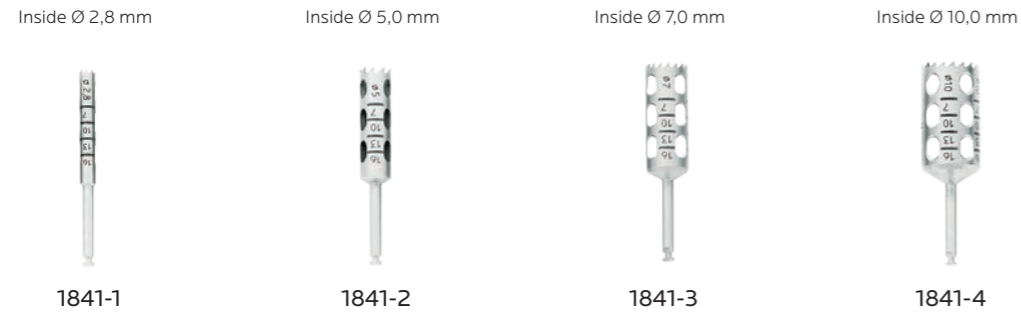

Burs holder

aluminum, suitable for steam sterilizing



colored silicone with plastic cover

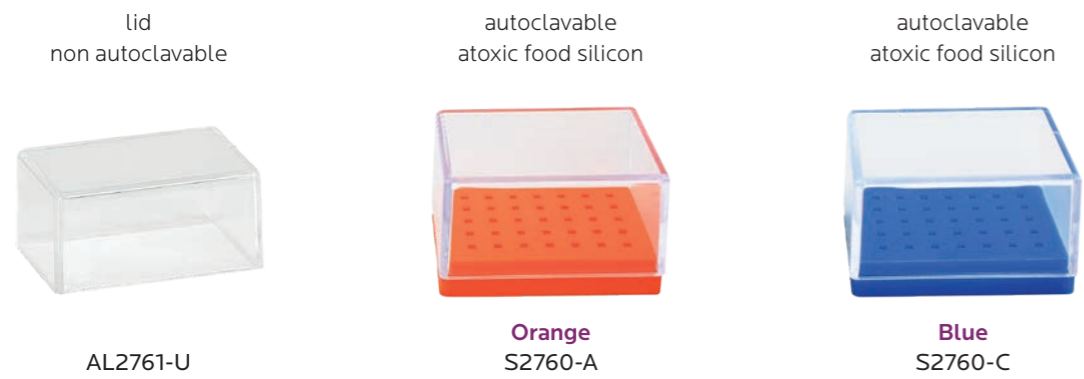

Bone compactors



Periodontal pocket markers



Tissue pliers

suture pliers

Membrane holding tweezers

Implant holding tweezers



1
Adson
12 cm
0620-1



1
Adson 1x2
12 cm
0621-1



1
Semken-Taylor
12.5 cm
0630-1



2
Semken-Taylor
12.5 cm
0630-2



0.16 mm
16 cm
PR0625-2



0.13 mm
17 cm
PR0625-3



10.5 cm
0660-1



9 cm
0660-2
with delicate ring tips



16.5 cm
0661-1



14.5 cm
0661-2



14.5 cm
0661-3

Implant surgery instruments

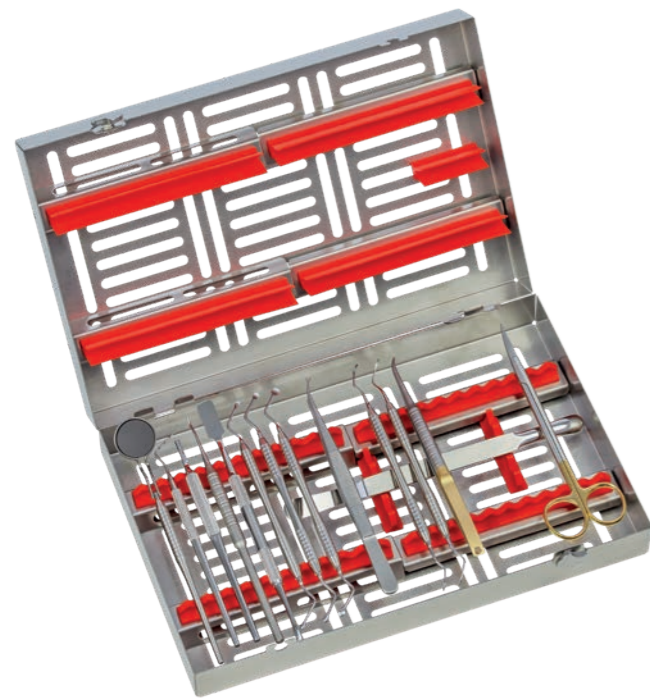

Implant surgery kit
SPR2781-I

	mouth mirror handle	ML2101
5	double sided mouth mirrors	22305
CP-15	periodontal pocket probes	0702L-15
5	scalpel handle and blade	0350-5
	exciser	PR1857-1
PR3	Prichard periosteal	MV1851-PR3
23	Seldin retractor	1855-23
85	Lucas bone curette	ML2001-85
87	Lucas bone curette	ML2001-87
88	Lucas bone curette	ML2001-88
	tissue pliers	PR0625-2
2R/2L	periodontal instrument	ML1806-2RL
4R/4L	periodontal instrument	ML1806-4RL
	Castroviejo needle holder	PR0460-15TC
2TC	gum scissors	0309-2TC
	sterilization cassette	2780-1R

Implant surgery instruments



Sinus lift mini kit
SPR0495

	osteotomes	0495-1
	osteotomes	0495-2
	osteotomes	0495-3
	osteotomes	0495-4
	osteotomes	0495-5
	osteotomes	0495-6
	mead mallet	1881
	sterilization cassette	2770-1R



Sinus lift maxi kit
SPR0496

	sinus lift	PR1859-1
	sinus lift	PR1859-2
	bone applicator	MV1231-1
	bone injector	0490-1
2	sinus lift curette	MV1856-2
	sterilization cassette	2770-3R



288 x 182 x h. 60 mm
S2780-IMP

	bone well	1030-4
	bone mill	1846
3	bone curettes	2014-3
	straight bone scraper	0494-1
	bone injector	0490-2
	bone injector	0490-1
1	compactor	MV1230-1
2	compactor	MV1230-2

Implant surgery instruments



Sinus lift mini kit
S0498-8

1B4	concave osteotome sinus lift	0498-1B4
2C4	concave osteotome sinus lift	0498-2C4
30B4	angular osteotome sinus lift	0498-30B4
PF4	flat osteotome sinus lift	0498-PF4
U15/30	Towner-Jacquette scaler	1902-2
1	Goldman-Fox Universal scaler	1809-1
31/32	Jacquette curette	1831-32
87	Lucas bone curette	2001-87
	instruments tray	S2702

Implant surgery instruments

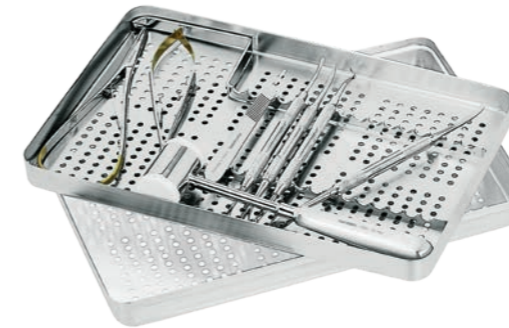

S3003-9

M9	Molt periosteal	MV1850-M9
PR3	Prichard periosteal	MV1851-PR3
GF	Goldman-Fox periosteal	MV1850-GF
15K/16K	Kirkland knife	MV1803-D
	Mead mallet	1881
	Castroviejo needle holder	0446-14TC
	Mathieu needle holder	0435-17TC
3	scalpel handle	0350-3
	instrument tray	S2722-1



Goracci kit
S3001-20

	gum scissors straight	0300-1
	Flagg cotton & dressing pliers	0601-1
23/17A	explorer d. e.	0704-23D2
2	cement spatulas double ended	0903-2
2	Heidemann separating spatulas	1101-2
2	filling instrument	1200-2
1L	filling instrument	1202-1L
2L	filling instrument	1202-2L
1T	Tanner filling instrument	1211-1T
	placement instrument	1301
1/2	Hollenback amalgam cavers	1500-02
1	cleodis discoids	1600-1
26	black margin trimmer	1601-1
27	black margin trimmer	1601-2
1	double ended excavator	1700-1
2	double ended excavator	1700-2
3	double ended excavator	1700-3
4	double ended excavator	1700-4
	mirror handle	2102-IN
5	mouth mirror plane	2200-5
	instruments tray	S2721-2



S3003-11

3	scalpel handle	0350-3
	Sternberg retractor	2602-1
2	Goldman-Fox scissor	0304-2
M9	Molt periosteal	MV1850-M9
PR3	Prichard periosteal	MV1851-PR3
	Crite-Wood needle holder	0415-15TC
1	Semken Taylor tissue plier	0631-1
23	explorer	0700-23
	mouth mirror handle	2102-IN
5	mouth mirror plane	2200-5
11	disposable blades (100 pcs)	0351-11
	instrument tray	S2722-1



RESTORATIVE

MADE IN ITALY

MAKE PEOPLE SMILE

This simple yet powerful idea drives every decision we take at Asa Dental. Whenever we choose materials, technologies, designs or manufacturing processes we make sure they will help dental professionals make people smile, anywhere in the world. Our Restorative instruments are first the result of a mindset, only after advanced technologies and skilled hands shape them.

This is how we manufacture durable excavators, precise carvers, effective burnishers, innovative isolation instruments and all the other products that allow the best practitioners to deliver aesthetically and functionally superior results.

- F2 Vision dental dam
- F4 Isolation clamps
- F8 Isolation instruments
- F13 Excavators
- F18 Cavity preparation instruments
- F20 Amalgam wells
- F20 Amalgam carriers
- F22 Spatulas
- F25 Filling instruments
- F36 Carvers
- F39 Operative instruments
- F40 Crown instruments
- F44 Hemostats
- F45 Scissors
- F46 Matrix
- F48 Composite instruments



Vision® Shade

dental dam

pack of 60 rubber dams
(black, mint-flavored dams)



VS3045

stainless steel dam frame
100x150 mm



VV3040-2

stainless steel magnetic locking tray



VV2731-6

stainless steel magnetic locking tray
with 6 clamps



SVS2731-6

clamps



210
winged
perfect for anterior teeth
VS3051-210



12A
winged, serrated
for lower right/upper left molar
VS3052-12A



W4
wingless
for upper/lower molars
VS3052-W4



2
winged
for lower/upper premolars
VS3052-2



13A
winged, serrated
for lower left/upper right molar
VS3052-13A



W8
wingless
for upper/lower molars
VS3052-W8

stainless steel clamp forceps

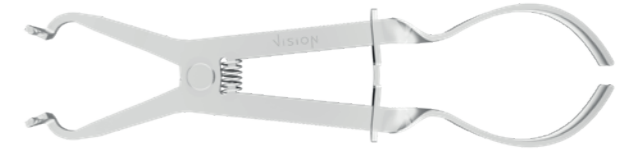

VV3030

stainless steel punch forceps



VV3033

stainless steel punching template

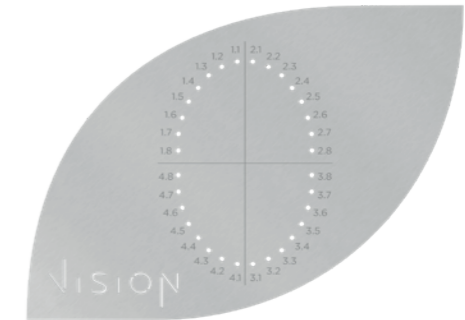

VV3035

marker suitable for food contact



VVPEN

Vision Shade Kit



SVS3000

Tooth numbering

Maxillary teeth	pattern
18 17 16	4 W4 8 W8 8A W8A 12A 14 14T W14 14A W14A 26 51 205 202
15 14	0 W0 1 1T W1 2A 2AT W2A 29
13 12 11 21 22 23	9 9T 212 210
24 25	0 W0 1 1T W1 2A 2AT W2A 29
26 27 28	4 W4 8 W8 8A W8A 13A 14 14T W14 14A W14A 26 51
Mandibular teeth	pattern
38 37 36	3 W3 7 W7 8A W8A 13A 14 14T W14 14A W14A
35 34	0 W0 2A 2AT W2A 2 2T W2 29
33 32 31 41 42 43	00 9 9T 212 210
44 45	0 W0 2 2T W2 2A -2AT W2A 29
46 47 48	3 W3 7 W7 12A 14 14T W14 14A W14A

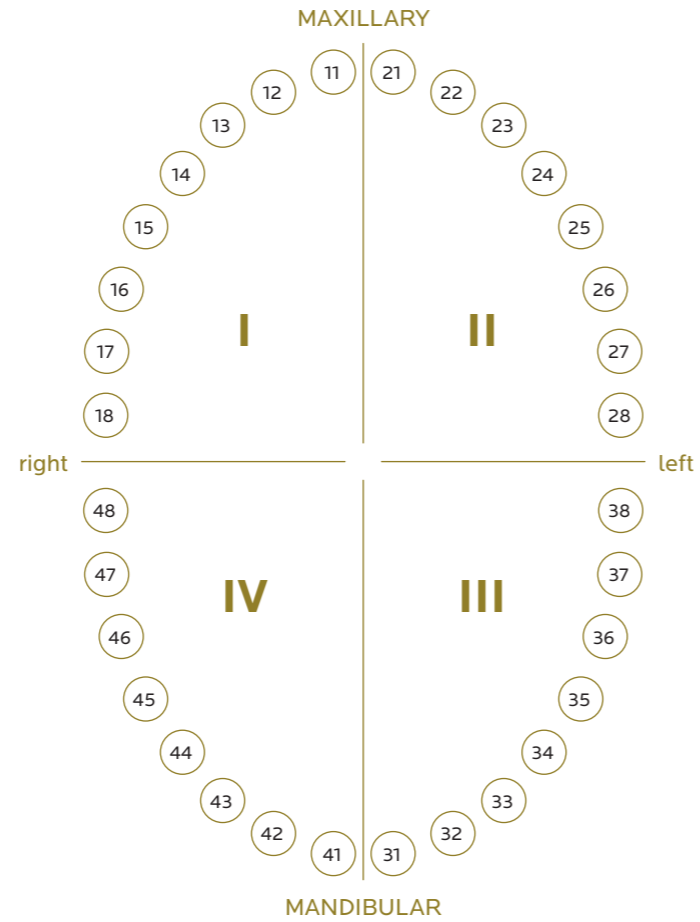

Classification

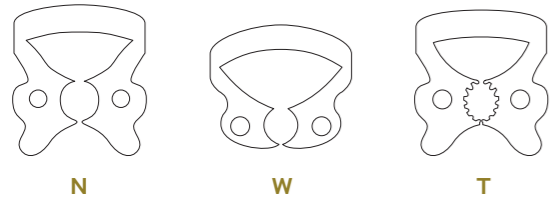

- N** = Standard (winged clamp)
- W** = Wingless (wingless clamp)
- T** = Tiger (serrated jaws)

Rubber dam clamps

ANTERIOR

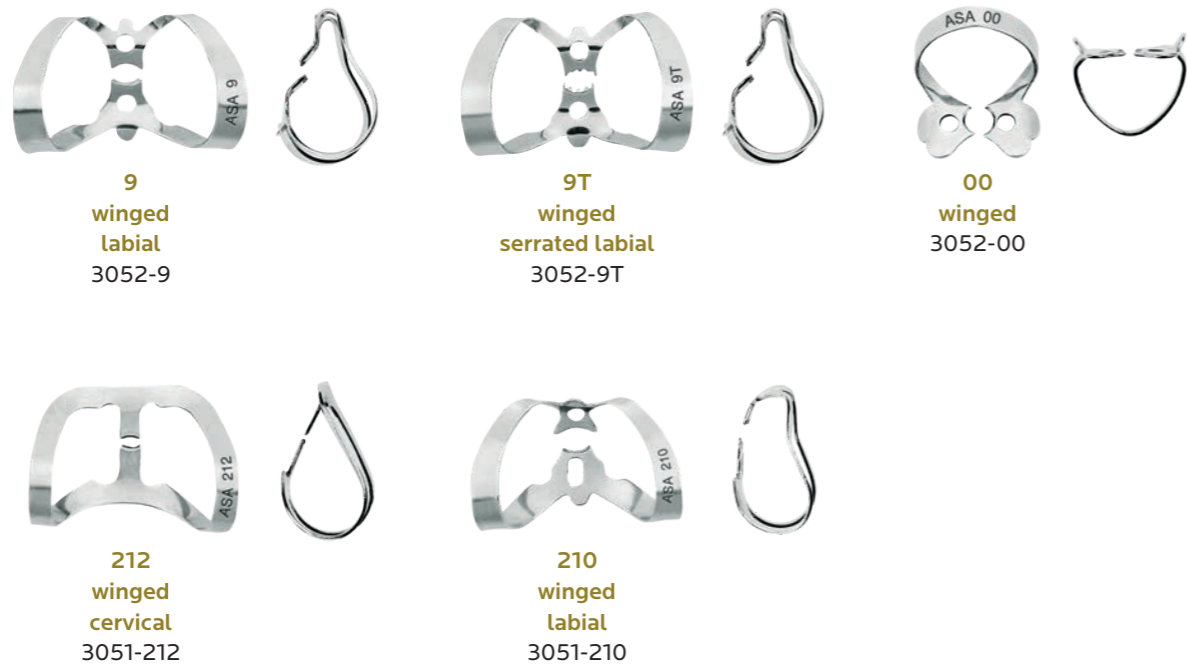

PREMOLARS

for elongated teeth
or with small necks



for general use upper
with adjustable jaws
according to gingival line
shapes



for premolars,
with large necks



for general purpose
lower premolars



primarily for lower
premolars



MOLARS

for small lower molars



3
winged
3052-3



W3
wingless
3052-W3



for square lower molars



7
winged
3052-7



W7
wingless
3052-W7



for molar roots



8A
winged
3052-8A



W8A
wingless
3052-W8A



for round molars,
partially broken,
undersized or inclined



14
winged
3052-14



14T
winged, serrated
3052-14T



W14
wingless
3052-W14



for upper molars



26
wingless
3051-26



51
wingless
3051-51

MOLARS

for small upper molars
with round collars



4
winged
3052-4



W4
wingless
3052-W4



for round upper molars



8
winged
3052-8



W8
wingless
3052-W8



for partially broken
lower molars



12A
winged, serrated
3052-12A



13A
winged, serrated
3052-13A



for large molars,
partially broken,
irregularly shaped
or inclined



14A
winged
3052-14A



W14A
wingless
3052-W14A



for large upper molars



202
winged
3051-202



205
winged
3051-205

Rubber dam instruments

AsaLady

products ergonomically designed for women hands:

- smaller and lighter handles
- smaller finger holes
- reduced size
- code starts with "W" or "SW"

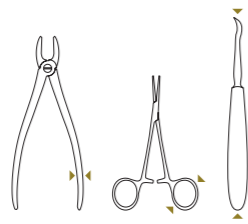

latex dam
vacuum packed
36 pcs / pack

15x15 cm (6"x 6")
3045



punch forceps



Ainsworth
17 cm
3032



Ainsworth
17 cm
W3036



Ivory
16.2 cm
3033

Rubber dam instruments



Rubber dam placed on an upper molar

rubber dam frame
stainless steel

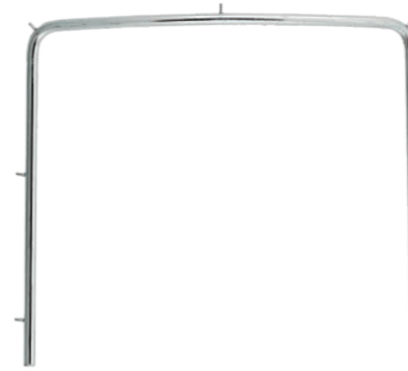

10x10 cm
3040-1

rubber dam frame
plastic
sterilizable
x-rays compatible



3041-1

clamp forceps



Ivory lightweight
17 cm
3030



Ivory lightweight
16 cm
W3035

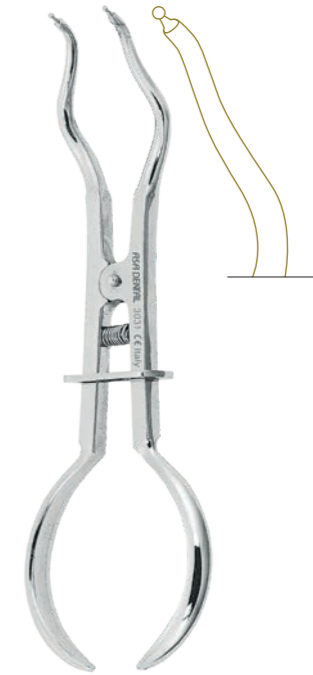

Brewer
17,5 cm
3031



Stoke
17,5 cm
3034

Rubber dam instrument kit



S3000

rubber dam instrument kit realised according to the instruction of Prof. GUIDO GORACCI, Senior Professor in the Department of Conservative Dentistry of Rome University, "LA SAPIENZA"

	stainless steel rubber dam frame	3040-1
	Brewer clamp forceps	3031
	Ivory punch forceps	3033
60	wingless bicuspid clamp	3050-60
26	wingless molar clamp	3051-26
51	wingless molar clamp	3051-51
29	wingless bicuspid clamp	3051-29
202	winged molar clamp	3051-202
205	winged molar clamp	3051-205
212	winged cervical clamp	3051-212
210	winged labial clamp	3051-210
	stainless steel rubber dam clamp tray	2731-1
	stainless steel instrument tray base	2720-L
	stainless steel instrument tray lid	2720-U
	stainless steel insert frame	2730-3

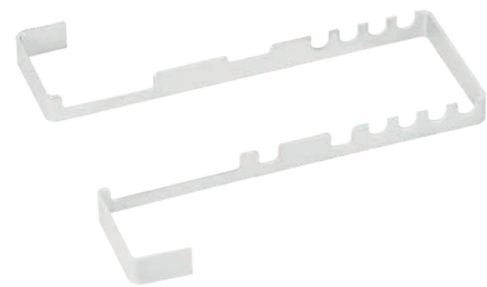

2730-3

stainless steel insert frame

Rubber dam instrument kit



S2731-1

stainless steel rubber dam clamp tray with 8 different clamps

60	wingless bicuspid clamp	3050-60
26	wingless molar clamp	3051-26
51	wingless molar clamp	3051-51
29	wingless bicuspid clamp	3051-29
202	winged molar clamp	3051-202
205	winged molar clamp	3051-205
212	winged cervical clamp	3051-212
210	winged labial clamp	3051-210
	stainless steel rubber dam clamp tray	2731-1



S2731-12

stainless steel rubber dam clamp tray with 12 different clamps

212	winged cervical clamp	3051-212
00	winged premolar clamp	3052-00
0	winged premolar clamp	3052-0
1	winged premolar clamp	3052-1
2A	winged premolar clamp	3052-2A
3	winged molar clamp	3052-3
7	winged molar clamp	3052-7
8	winged molar clamp	3052-8
8A	winged molar roots clamp	3052-8A
12A	serrated and winged molar clamp	3052-12A
13A	serrated and winged molar clamp	3052-13A
14	winged molar clamp	3052-14
	stainless steel rubber dam clamp tray	2731-1



2731-1

stainless steel rubber dam clamp tray (without clamps)

Handle options

SINGLE END

Asa35
(stainless steel)
ø 3.5 mm



Asa60
(stainless steel)
ø 6.0 mm



Octagonal
(stainless steel)
ø 5.5 mm



DOUBLE END

Asa60
(stainless steel)
ø 6.0 mm



Asa Light MV
(stainless steel, hollow)
ø 8.0 mm



Leonardo ML
(stainless steel)
ø 7.0 mm



Octagonal
(stainless steel)
ø 5.5 mm



● Alu60
(aluminum)
ø 6.0 mm



● Alu80
(aluminum, hollow)
ø 8.0 mm



● Magic Color MC
(aluminum core and non-slip plastic)
ø 8.0 / 10.5 mm



How to use

- 1/2 Wedelstaet → pattern + scientific name
- MV1604-02 → Asa Dental code
- Asa Light MV → handle option

AsaLady

- products ergonomically designed for women hands:
- smaller and lighter handles
 - smaller finger holes
 - reduced size
 - code starts with "W" or "SW"

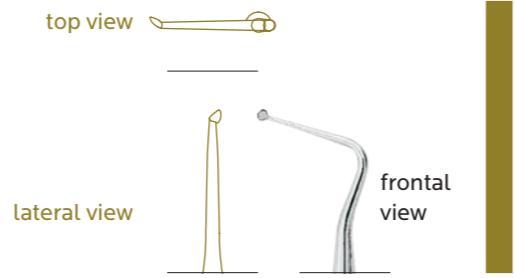
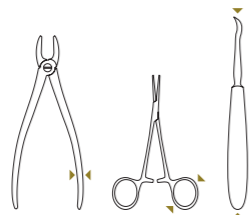

Excavators - spoons

set of 5

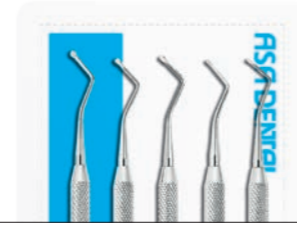

0 · 1 · 2 · 3 · 4
S1700
Asa60
SMV1700
Asa Light MV

0
S1700-0
Asa60

2
S1700-2
Asa60

3
S1700-3
Asa60

4
S1700-4
Asa60

0.8 mm



0
1700-0
Asa60
MV1700-0
Asa Light MV

1.2 mm

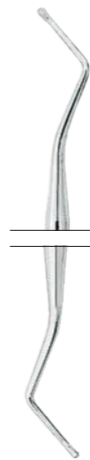

1
1700-1
Asa60
MV1700-1
Asa Light MV
MC1700-1
● Magic Color MC

1.4 mm



2
1700-2
Asa60
MV1700-2
Asa Light MV
MC1700-2
● Magic Color MC

1.5 mm

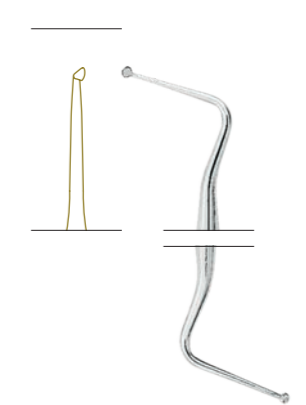

1
1701-1
Asa60
MV1701-1
Asa Light MV

1.6 mm

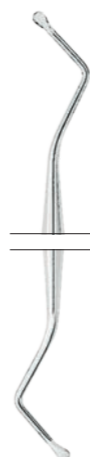

3
1700-3
Asa60
MV1700-3
Asa Light MV
MC1700-3
● Magic Color MC

2 mm

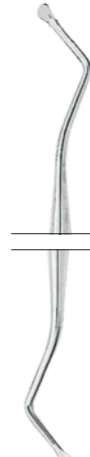

4
1700-4
Asa60
MV1700-4
Asa Light MV

2 mm

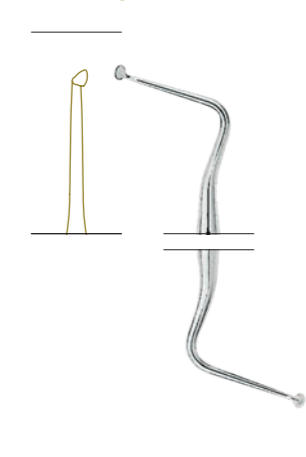

2
1701-2
Asa60
MV1701-2
Asa Light MV

Excavators - spoons

Excavators - oval spoons

Excavators - ASH

<p>1.2 mm</p>  <p>6 1702-6 Asa60 MV1702-6 Asa Light MV</p>	<p>1.5 mm</p>  <p>14 1703-14 Asa60 MV1703-14 Asa Light MV MC1703-14 ● Magic Color MC</p> <p>2.2 mm</p>  <p>19 1706-19 Asa60 MV1706-19 Asa Light MV</p>	<p>1.2 mm</p>  <p>17 1704-17 Asa60 MV1704-17 Asa Light MV MC1704-17 ● Magic Color MC</p> <p>1.2 mm</p>  <p>31L 1709-31L Asa60 MV1709-31L Asa Light MV</p>	<p>1.5 mm</p>  <p>18 1705-18 Asa60 MV1705-18 Asa Light MV</p> <p>1.5 mm</p>  <p>32L 1709-32L Asa60 MV1709-32L Asa Light MV</p>	<p>1.2 mm</p>  <p>38/39 1707-39 Asa60 MV1707-39 Asa Light MV</p> <p>2 mm</p>  <p>33L 1709-33L Asa60 MV1709-33L Asa Light MV</p>	<p>1.2 mm</p>  <p>17W 1704-17W Asa60 MV1704-17W Asa Light MV</p>	<p>1.5 mm</p>  <p>18W 1705-18W Asa60 MV1705-18W Asa Light MV</p>	<p>2 mm</p>  <p>19W 1706-19W Asa60 MV1706-19W Asa Light MV</p>	<p>1 mm</p>  <p>243 1711-243 Asa60 ML1711-243 Leonardo ML</p>	<p>1.4 mm</p>  <p>G2 1711-G2 Asa60 ML1711-G2 Leonardo ML</p>
---	--	---	--	---	---	---	---	--	---

Excavators - SS. white type

set of 6



5 · 14 · 17 · 18 · 19 · 20
S1710-6
Asa60

1 mm



5
1710-5
Asa60
ML1710-5
Leonardo ML

1.2 mm

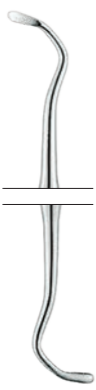

14
1710-14
Asa60
ML1710-14
Leonardo ML

1 mm

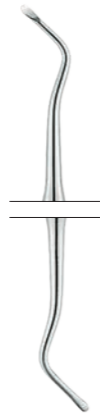

17
1710-17
Asa60
ML1710-17
Leonardo ML

2 mm



20
1710-20
Asa60
ML1710-20
Leonardo ML

1.2 mm

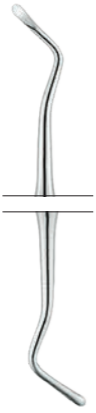

18
1710-18
Asa60
ML1710-18
Leonardo ML

1.6 mm

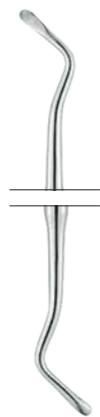

19
1710-19
Asa60
ML1710-19
Leonardo ML

Excavators - Darby-Perry

0.8 mm



1 Darby-Perry
1711-1
Asa60
ML1711-1
Leonardo ML

0.8 mm

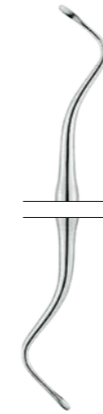

2 Darby-Perry
1711-2
Asa60
ML1711-2
Leonardo ML

1 mm

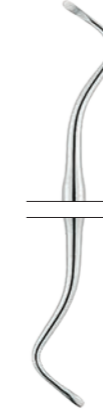

11 Darby-Perry
1711-11
Asa60
ML1711-11
Leonardo ML

1 mm

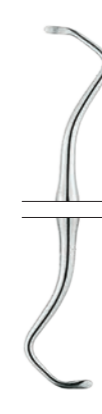

12 Darby-Perry
1711-12
Asa60
ML1711-12
Leonardo ML

1 mm

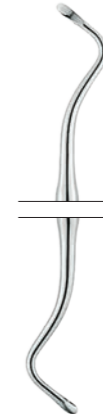

21 Darby-Perry
1711-21
Asa60
ML1711-21
Leonardo ML

2 mm



42 Darby-Perry
1711-42
Asa60
ML1711-42
Leonardo ML

1.2 mm



22 Darby-Perry
1711-22
Asa60
ML1711-22
Leonardo ML

1.6 mm

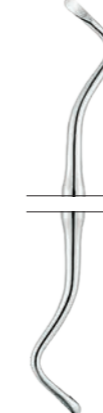

31 Darby-Perry
1711-31
Asa60
ML1711-31
Leonardo ML

1.6 mm

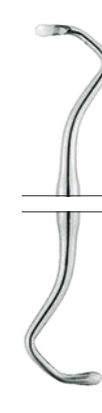

32 Darby-Perry
1711-32
Asa60
ML1711-32
Leonardo ML

2 mm

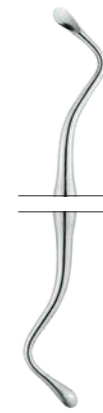

41 Darby-Perry
1711-41
Asa60
ML1711-41
Leonardo ML

Cavity preparation instruments - margin trimmers

Cavity preparation instruments hatchets

Cavity preparation instruments chisels



1 Black/26
distal
1601-1
Asa60
MV1601-1
Asa Light MV

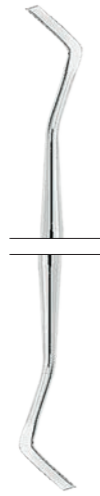

2 Black/27
mesial
1601-2
Asa60
MV1601-2
Asa Light MV

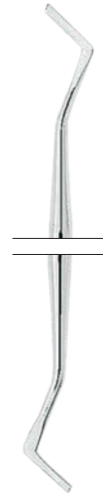

3 Black/28
distal
1601-3
Asa60
MV1601-3
Asa Light MV



4 Black/29
mesial
1601-4
Asa60
MV1601-4
Asa Light MV



1 Black/77-78
distal
1602-1
Asa60
MV1602-1
Asa Light MV



2 Black/79-80
mesial
1602-2
Asa60
MV1602-2
Asa Light MV



1 Black/53-54
1603-1
Asa60
MV1603-1
Asa Light MV



2 Black/51-52
1603-2
Asa60
MV1603-2
Asa Light MV



1/2 Wedelstaet
1604-02
Asa60
MV1604-02
Asa Light MV



3/4 Wedelstaet
1604-04
Asa60
MV1604-04
Asa Light MV



5/6 Wedelstaet
1604-06
Asa60
MV1604-06
Asa Light MV

Amalgam carriers

Ø 1.5 mm



medium/small
20 cm
1015-1

Ø 2.5 mm

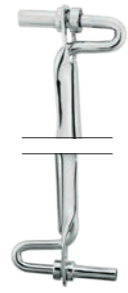

medium/large
20 cm
1015-2

Ø 3 mm

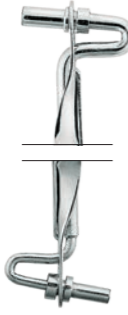

medium/jumbo
20 cm
1015-3

Ø 2 mm



small
15.5 cm
1011-1

Ø 2 mm



medium
15.5 cm
1011-2

Ø 2.5 mm



large
15.5 cm
1011-3

Ø 3 mm



jumbo
15.5 cm
1011-4

Amalgam wells

cold sterilization only



Ø 3.5 cm
h. 3.5 cm
1030-1



Ø 2 cm
h. 4 cm
1030-2



Ø 2 cm
h. 2.5 cm
1030-3

Amalgam carriers

Ø 2 mm



straight
15 cm
1020-1

Ø 2 mm



45°
15 cm
1020-2

Ø 2 mm



90°
15 cm
1020-3

Ø 2 mm



metal tip
for 1020-1-2-3
1020-2P

Ø 1.2 mm



straight
for retrograds
13 cm
1009-1

Ø 1.2 mm



curved
for retrograds
13 cm
1009-2

Ø 1.8 mm



straight
for retrograds
13 cm
1009-3

Ø 1.8 mm



curved
for retrograds
13 cm
1009-4

autoclavable plastic



15.5 cm
1021-1
tip + handle

Ø 2 mm



straight
1021-1
tip + handle
1021-1P
spare tip
(10 pcs / bag)

Ø 2 mm



45°
1021-2
tip + handle
1021-2P
spare tip
(10 pcs / bag)

Ø 2 mm



90°
1021-3
tip + handle
1021-3P
spare tip
(10 pcs / bag)

Cement spatulas

set of 5



- 1 S0903-1
- 2 S0903-2
- 3 S0903-3

glass plate

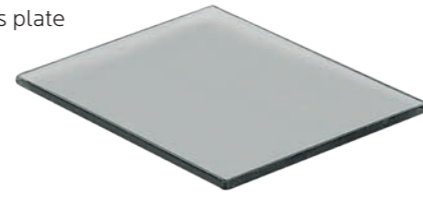

8x12x0.5 cm
0999-1

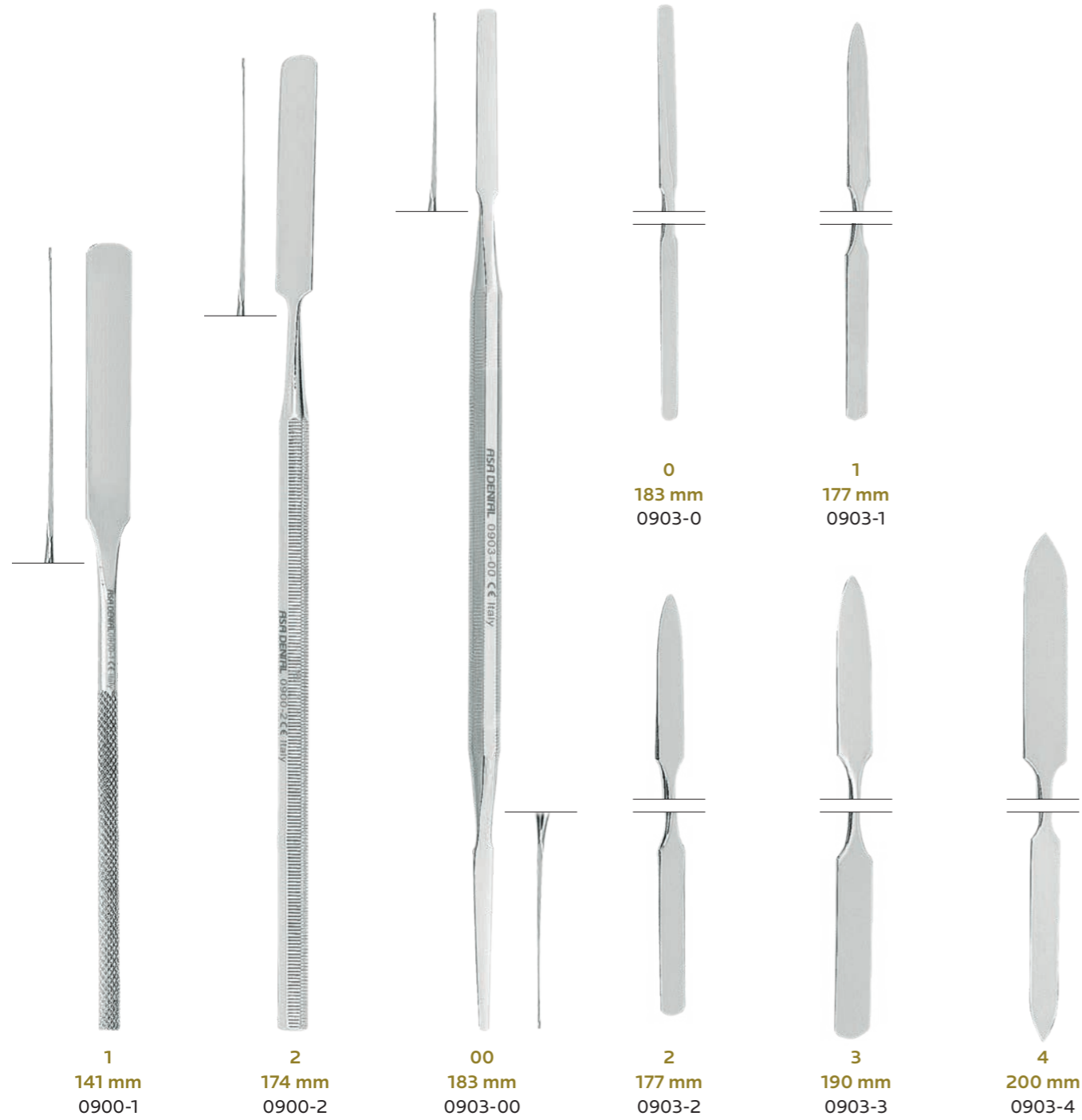

Heidemann separating spatulas



Heidemann separating spatulas

set of 5



- 1
S1102-1
Asa60
- 2
S1102-2
Asa60
- 3
S1102-3
Asa60

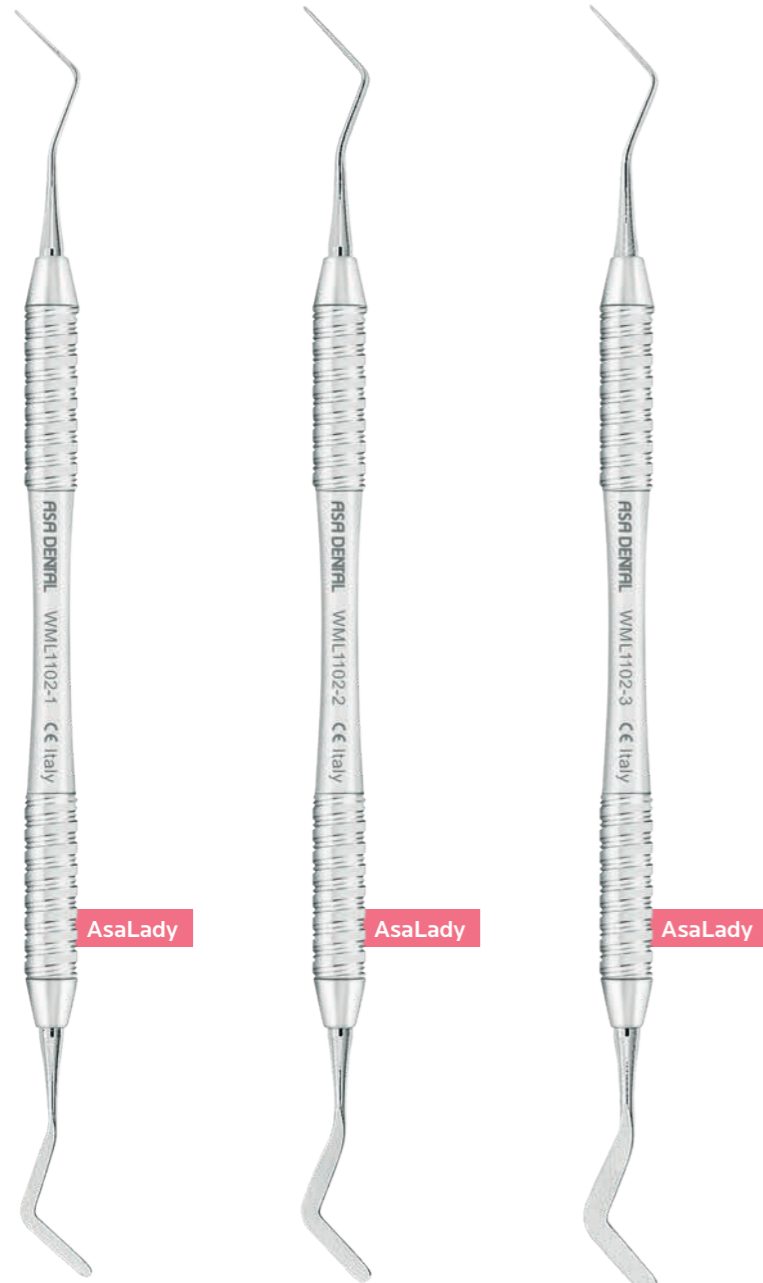

AsaLady

AsaLady

AsaLady

- 1
1102-1
Asa60
MV1102-1
Asa Light MV
WML1102-1
Leonardo ML
MC1102-1
● Magic Color MC
- 2
1102-2
Asa60
MV1102-2
Asa Light MV
WML1102-2
Leonardo ML
MC1102-2
● Magic Color MC
- 3
1102-3
Asa60
MV1102-3
Asa Light MV
WML1102-3
Leonardo ML

Heidemann separating spatulas

with titanium nitride coating

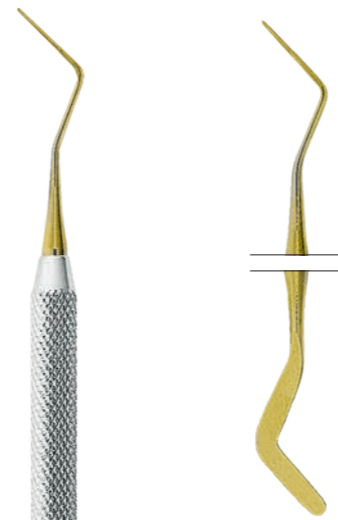

- 3
1102T-3
Asa60

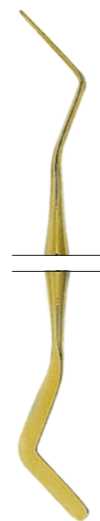

- 1
1102T-1
Asa60
- 2
1102T-2
Asa60

Filling instruments - amalgam instruments

with titanium nitride coating

set of 5

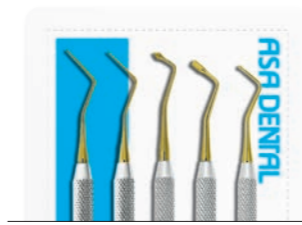

- 1200T-1 · 1202T-2 · 1204T-1
- 1102T-1 · 1102T-2
- S1200T
- Asa60

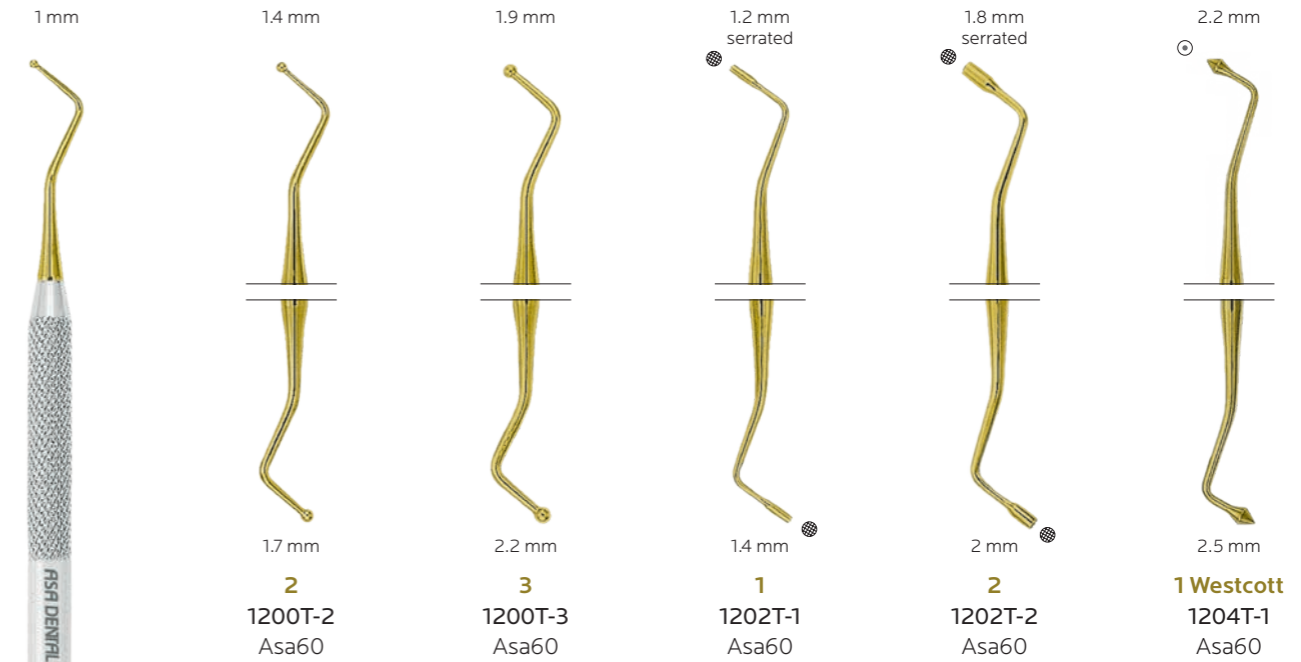

1200T-2

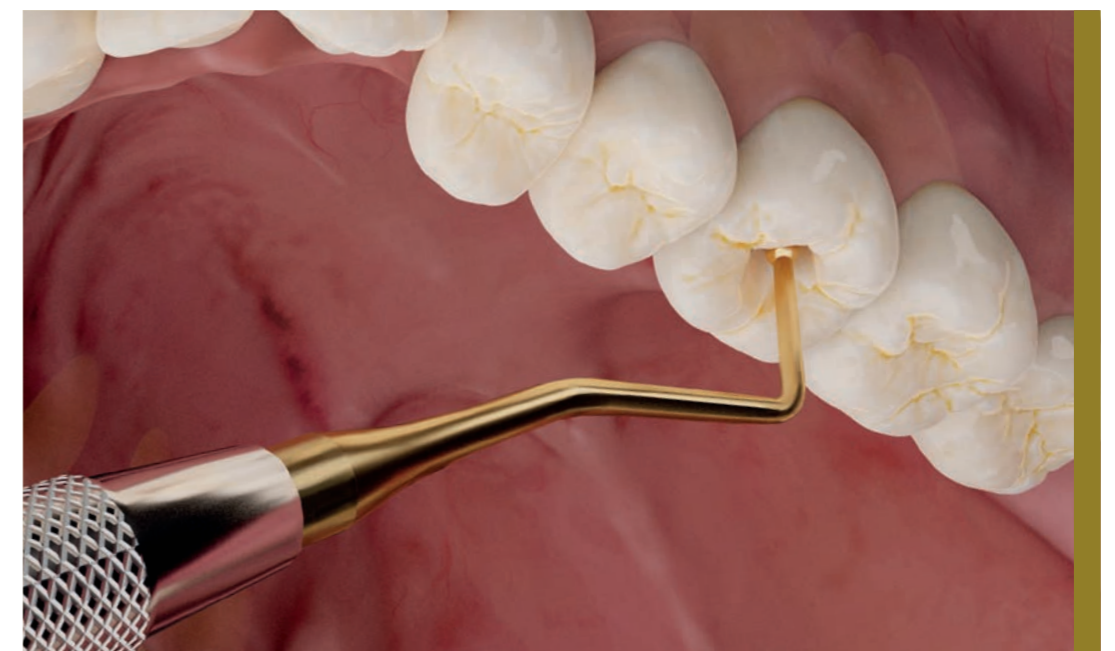

Filling instruments - amalgam instruments

set of 5

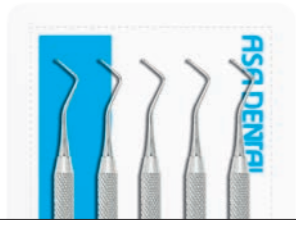

- | | |
|------------------------------|------------------------------|
| 1
S1200-1
Asa60 | 3
S1200-3
Asa60 |
| 2
S1200-2
Asa60 | 4
S1200-4
Asa60 |
| | 5
S1200-5
Asa60 |

Filling instruments - amalgam instruments

1 mm	1 mm	1.9 mm	1 mm serrated	1.6 mm serrated	2.1 mm serrated	1.2 mm serrated	1.8 mm serrated	2.3 mm serrated	3 mm serrated	1.2 mm non-serrated	1.8 mm non-serrated
1.8 mm	2.2 mm	1 mm	2 mm	2.3 mm	2 mm	2.6 mm	3.2 mm	1.4 mm	2 mm		
2 1200-2 Asa60 MV1200-2 Asa Light MV	3 1200-3 Asa60 MV1200-3 Asa Light MV	1 1201-1 Asa60 MV1201-1 Asa Light MV	2 1201-2 Asa60 MV1201-2 Asa Light MV	3 1201-3 Asa60 MV1201-3 Asa Light MV	2 1202-2 Asa60 MV1202-2 Asa Light MV MC1202-2	3 1202-3 Asa60 MV1202-3 Asa Light MV	4 1202-4 Asa60 MV1202-4 Asa Light MV	1L 1202-1L Asa60 MV1202-1L Asa Light MV	2L 1202-2L Asa60 MV1202-2L Asa Light MV		
	2.5 mm	1.7 mm	1 mm non-serrated	1.6 mm non-serrated	2.1 mm non-serrated		2.3 mm non-serrated	3 mm non-serrated	1 mm	1.4 mm	1.8 mm
1.2 mm	2.9 mm	2.9 mm	1.2 mm	2 mm	2.3 mm	1.4 mm	2.6 mm	3.2 mm	1.2 mm	1.6 mm	2 mm
1 1200-1 Asa60 MV1200-1 Asa Light MV	4 1200-4 Asa60 MV1200-4 Asa Light MV	5 1200-5 Asa60 MV1200-5 Asa Light MV	1L 1201-1L Asa60 MV1201-1L Asa Light MV	2L 1201-2L Asa60 MV1201-2L Asa Light MV	3L 1201-3L Asa60 MV1201-3L Asa Light MV	1 1202-1 Asa60 MV1202-1 Asa Light MV	3L 1202-3L Asa60 MV1202-3L Asa Light MV	4L 1202-4L Asa60 MV1202-4L Asa Light MV	1 1203-1 Asa60 MV1203-1 Asa Light MV	2 1203-2 Asa60 MV1203-2 Asa Light MV	3 1203-3 Asa60 MV1203-3 Asa Light MV

● Magic Color MC

Filling instruments - amalgam instruments





Filling instruments - Markley amalgam instruments

<p>1.5 mm</p>  <p>2 mm</p> <p>1 Ward 1205-1 Asa60 MV1205-1 Asa Light MV</p>	<p>2.4 mm</p>  <p>2.8 mm</p> <p>2 Ward 1205-2 Asa60 MV1205-2 Asa Light MV</p>	<p>1.4 mm</p>  <p>0.8 mm</p> <p>OT Tanner 1211-OT Asa60 MV1211-OT Asa Light MV</p>	<p>2.4 mm</p>  <p>1.4 mm</p> <p>1T Tanner 1211-1T Asa60 MV1211-1T Asa Light MV</p>	<p>1.2 mm</p>  <p>0.8 mm</p> <p>2T Tanner 1211-2T Asa60 MV1211-2T Asa Light MV</p>	<p>1.8 mm</p>  <p>1.5 mm</p> <p>3T Tanner 1211-3T Asa60 MV1211-3T Asa Light MV</p>
<p>1 mm serrated</p>  <p>1.4 mm</p> <p>01 Marquette 1212-01 Asa60 MV1212-01 Asa Light MV</p>	<p>1.5 mm</p>  <p>1 mm</p> <p>H1 Hollenback 1213-H1 Asa60 MV1213-H1 Asa Light MV</p>	<p>3 mm</p>  <p>2 mm</p> <p>H2 Hollenback 1213-H2 Asa60 MV1213-H2 Asa Light MV</p>	<p>2.6 mm</p>  <p>1 mm</p> <p>H3 Hollenback 1213-H3 Asa60 MV1213-H3 Asa Light MV</p>	<p>1.8 mm</p>  <p>2.6 mm</p> <p>H4 Hollenback 1213-H4 Asa60 MV1213-H4 Asa Light MV</p>	

set of 6

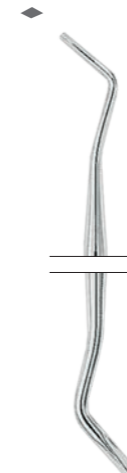
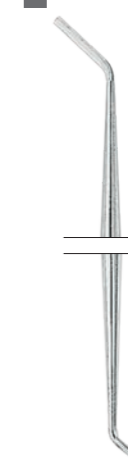

1 · 2 · 3 · 4 · 5 · 6
S1400
Asa60
1 · 2 · 3 · 4 · 5 · 6
SMV1400
Asa Light MV

<p>0.4 mm</p>  <p>0.6 mm</p> <p>1 Markley 1400-1 Asa60 MV1400-1 Asa Light MV</p>	<p>0.5 mm</p>  <p>1 mm</p> <p>2 Markley 1400-2 Asa60 MV1400-2 Asa Light MV MC1400-2 ● Magic Color MC</p>	<p>0.4 mm</p>  <p>1.2 mm</p> <p>3 Markley 1400-3 Asa60 MV1400-3 Asa Light MV</p>	<p>0.4 mm</p>  <p>1.6 mm</p> <p>4 Markley 1400-4 Asa60 MV1400-4 Asa Light MV</p>	<p>1.2 mm</p>  <p>0.5 mm</p> <p>5 Markley 1400-5 Asa60 MV1400-5 Asa Light MV</p>	<p>3 mm</p>  <p>1.6 mm</p> <p>6 Markley 1400-6 Asa60 MV1400-6 Asa Light MV</p>
---	--	--	--	--	---

Filling instruments - Foc amalgam instruments



0 Foc
1401-0
Asa60
ML1401-0
Leonardo ML

1S Foc
1401-1S
Asa60
ML1401-1S
Leonardo ML

2 Foc
1401-2
Asa60
ML1401-2
Leonardo ML

2S Foc
1401-2S
Asa60
ML1401-2S
Leonardo ML

0S Foc
1401-0S
Asa60
ML1401-0S
Leonardo ML

1 Foc
1401-1
Asa60
ML1401-1
Leonardo ML

Filling instruments - Burnishers

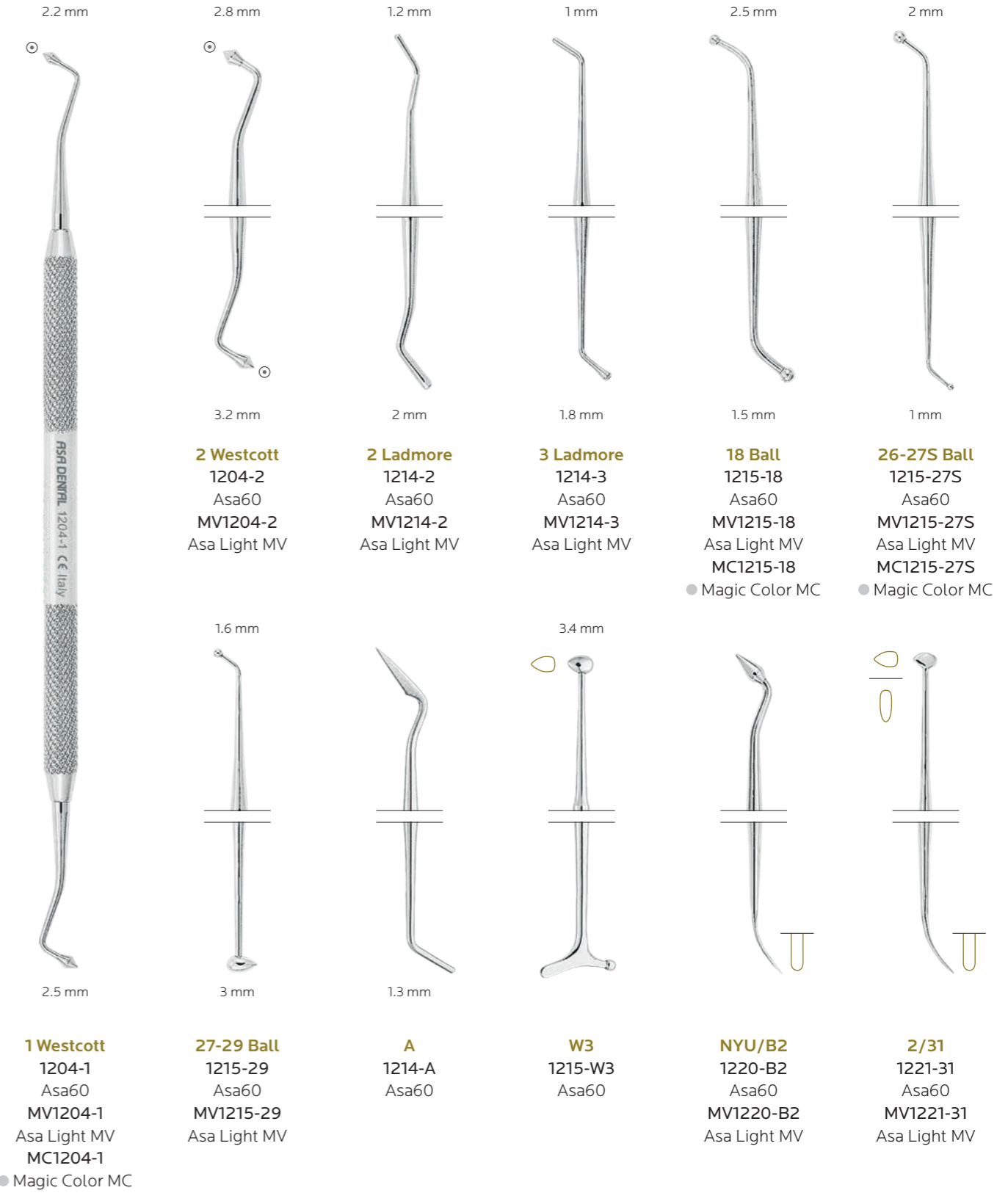

1 Westcott
1204-1
Asa60
MV1204-1
Asa Light MV
MC1204-1
● Magic Color MC

27-29 Ball
1215-29
Asa60
MV1215-29
Asa Light MV

A
1214-A
Asa60

W3
1215-W3
Asa60

NYU/B2
1220-B2
Asa60
MV1220-B2
Asa Light MV

2/31
1221-31
Asa60
MV1221-31
Asa Light MV

2 Westcott
1204-2
Asa60
MV1204-2
Asa Light MV

2 Ladmore
1214-2
Asa60
MV1214-2
Asa Light MV

3 Ladmore
1214-3
Asa60
MV1214-3
Asa Light MV

18 Ball
1215-18
Asa60
MV1215-18
Asa Light MV
MC1215-18
● Magic Color MC

26-27S Ball
1215-27S
Asa60
MV1215-27S
Asa Light MV
MC1215-27S
● Magic Color MC

Felt composite instruments

set of 6



1 · 2 · 3 · 4 · 5 · 6
S1220
● Alu60



1 Felt
1220-1
● Alu60

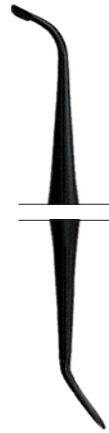

2 Felt
1220-2
● Alu60



4 Felt
1220-4
● Alu60

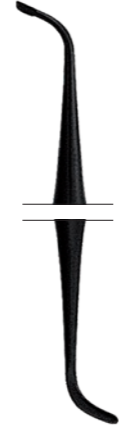

3 Felt
1220-3
● Alu60

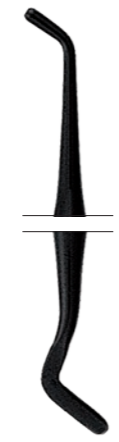

5 Felt
1220-5
● Alu60



6 Felt
1220-6
● Alu60

Plastic filling instruments

with titanium nitride coating

1 mm



1
1208T-1
Asa60

1.6 mm



2
1208T-2
Asa60

2 mm



3
1208T-3
Asa60

2 mm



2
1209T-2
Asa60





2.9 mm





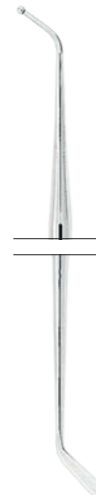



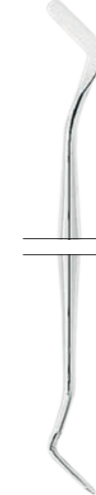

2
1210T-2
Asa60

Plastic filling instruments

Plastic filling instruments

1.2 mm  0.1 mm 1 1206-1 Asa60 MV1206-1 Asa Light MV	1.6 mm  0.1 mm 2 1206-2 Asa60 MV1206-2 Asa Light MV	1.2 mm  2.2 mm 1 1207-1 Asa60 MV1207-1 Asa Light MV	1.6 mm  2.7 mm 2 1207-2 Asa60 MV1207-2 Asa Light MV	1 mm  2 mm 1 1208-1 Asa60 MV1208-1 Asa Light MV	2.5 mm  0.1 mm 3 1209-3 Asa60 MV1209-3 Asa Light MV
0.7 mm  2.5 mm 2 1208-2 Asa60 MV1208-2 Asa Light MV	2.5 mm  3 mm 3 1208-3 Asa60 MV1208-3 Asa Light MV	1 mm  0.1 mm 1 1209-1 Asa60 MV1209-1 Asa Light MV	2 mm  0.1 mm 2 1209-2 Asa60 MV1209-2 Asa Light MV		

 0.1 mm 1 1210-1 Asa60 MV1210-1 Asa Light MV	 2 1210-2 Asa60 MV1210-2 Asa Light MV MC1210-2 ● Magic Color MC	 3 1210-3 Asa60 MV1210-3 Asa Light MV	 1 Woodson 1216-1 Asa60 MV1216-1 Asa Light MV	 2 Woodson 1216-2 Asa60 MV1216-2 Asa Light MV
 3 Woodson 1216-3 Asa60 MV1216-3 Asa Light MV	 11 1217-11 Asa60 MV1217-11 Asa Light MV	 6 1218-6 Asa60 MV1218-6 Asa Light MV	 179 1219-179 Asa60 MV1219-179 Asa Light MV	

Amalgam carvers

Amalgam carvers



1/2 Hollenback
1500-02
Asa60
MV1500-02
Asa Light MV
MC1500-02

● Magic Color MC

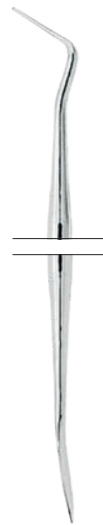

1 Ward
1501-1
Asa60
MV1501-1
Asa Light MV



2 Ward
1501-2
Asa60
MV1501-2
Asa Light MV

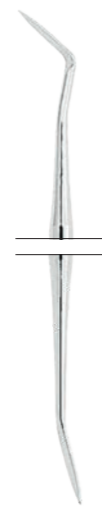

1S Ward
1501-1S
Asa60
MV1501-1S
Asa Light MV

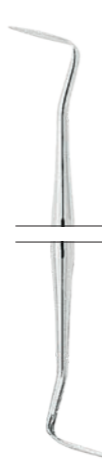

3 Hollenback
1500-3
Asa60
MV1500-3
Asa Light MV



3S Hollenback
1500-3S
Asa60
MV1500-3S
Asa Light MV



1 Frahm
1502-1
Asa60
MV1502-1
Asa Light MV

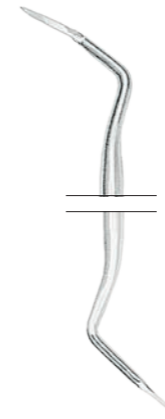

2 USC
1503-2
Asa60



SHO-A
1505-A
Asa60



1 Interproximal
1504-1
Asa60



3-SHO
1505-3
Asa60

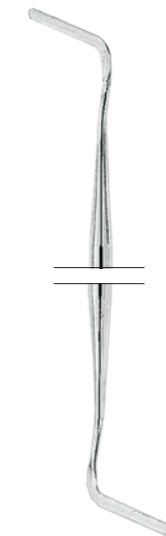

2 Interproximal off-angle
1504-2
Asa60



104
1506-104
Asa60



8 Wiland
1507-8
Asa60
MV1507-8
Asa Light MV

Amalgam carvers



1 cleoid-discoïd 1600-1
Asa60
MV1600-1
Asa Light MV
MC1600-1

2 cleoid-discoïd 1600-2
Asa60
MV1600-2
Asa Light MV

3 cleoid-discoïd 1600-3
Asa60
MV1600-3
Asa Light MV

4 cleoid-discoïd 1600-4
Asa60
MV1600-4
Asa Light MV

● Magic Color MC

instruments for retractor wire



1 1310-1
Asa60

2 1310-2
Asa60

Operative instruments

medication instrument

placement instruments

gauze packers



Orban Loop
1303
Octagonal



1300
Asa35



1301
Asa60
MV1301
Asa Light MV



1302
Asa60
MV1302
Asa Light MV



1 Luniatschek
2 mm
1355-1
Octagonal



2 Luniatschek
3 mm
1355-2
Octagonal

Crown instruments

crown removers
complete with tips
double ended

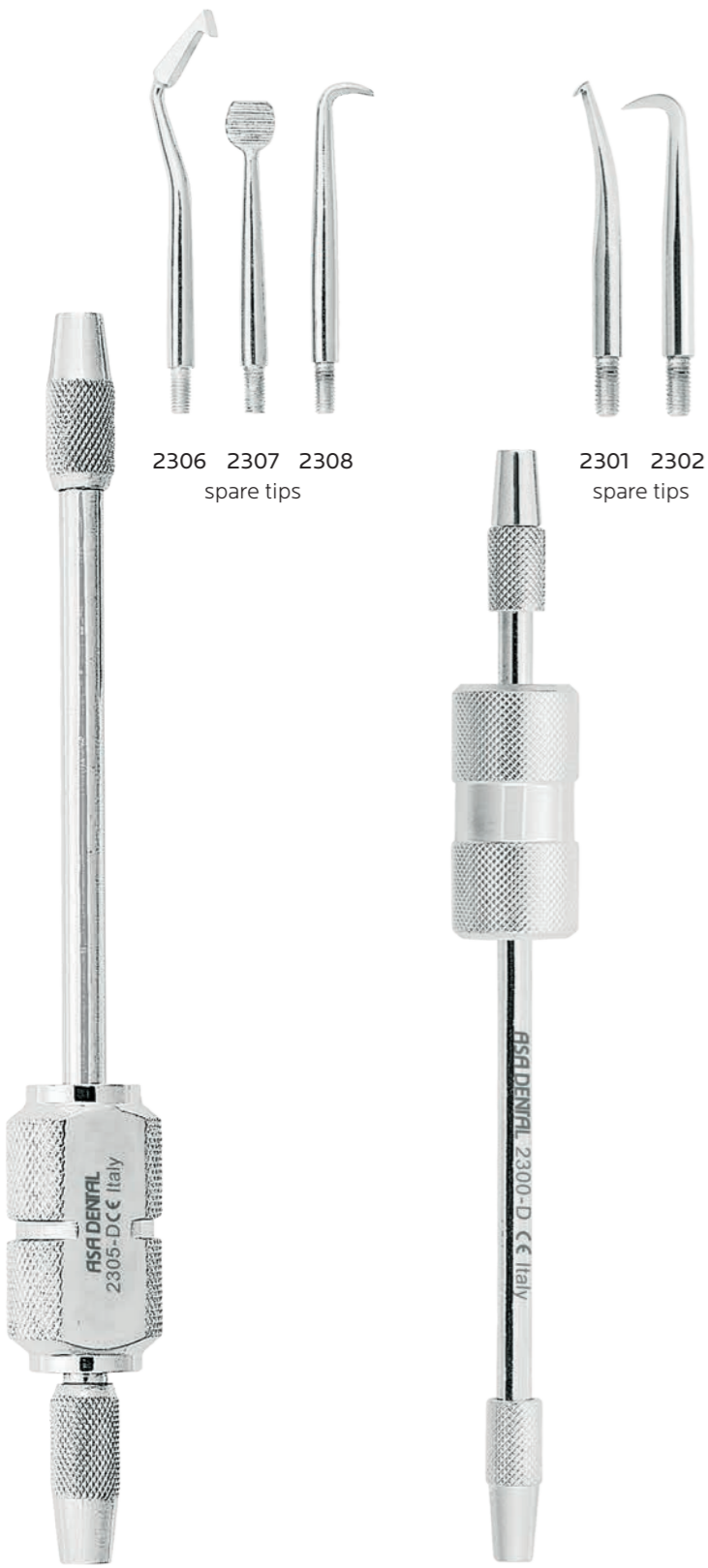

2305-D
handle + 3 tips

2300-D
handle + 2 tips

2300-S
handle + 2 tips

crown remover
complete with tips
single ended



2320

Crown instruments

crown spreaders



0
2340-0

1
2340-1

2
2340-2

3
2340-3

Crown instruments

decimal calipers

measuring range: 0-10 mm
(indicative measures)



**Iwanson
for wax**
2550-1

measuring range: 0-10 mm
(indicative measures)



**Iwanson
for metal**
2550-2

measuring range: 0-100 mm
(indicative measures)

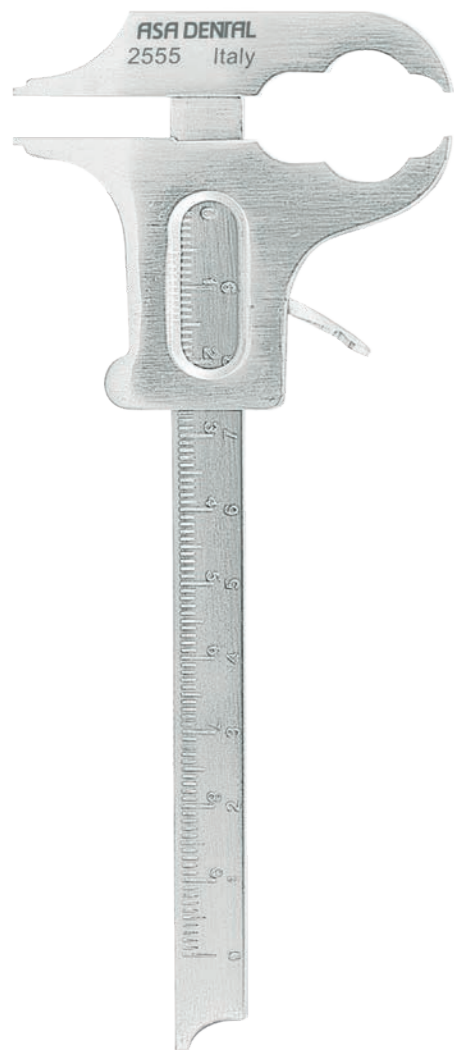

Boley
14 cm
2555

articulating paper forceps



Miller
15 cm
0670
15 cm
0671

Crown instruments

telescope crown pliers

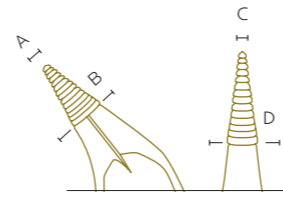

A	4.4 mm
B	5.0 mm

C	3.4 mm
D	3.8 mm

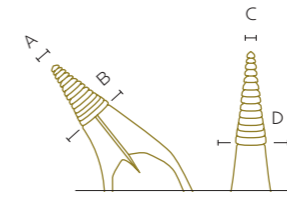

A	3.3 mm
B	4.0 mm

C	2.3 mm
D	3.0 mm



Böhm
14.5 cm
2500-2



Böhm
11.5 cm
2500-1

copper rings removing pliers



**Furrer
straight**
16 cm
2331-1



**Furrer
curved**
16 cm
2331-2

Hemostats



1 Halstead-Mosquito
straight
12 cm
0500-1



1 Micro-Mosquito
straight
10 cm
0501-1



1 Kelly
straight
14 cm
0510-1

Scissors

for gold foils



1
straight
12 cm
0300-1

wire scissor
with tungsten carbide blades



TC Universal
12 cm
5700TC

wire scissor
one blade serrated



Universal
12 cm
5700

Crown scissors



1
straight
one blade serrated
10.5 cm
5600-1



2
curved
one blade serrated
10.5 cm
5600-2



1
straight
10.5 cm
5601-1



2
curved
10.5 cm
5601-2

Matrix retainers



8 Ivory
5 mm
3070-5

8 Ivory
6 mm
3070-6

8 Ivory
7 mm
3070-7

8N Ivory
3071



8P Didner
3072

Tofflemire
Universal
3073-1

Tofflemire
Junior
3073-2

Tofflemire
Senior
3073-3

Matrix

bands

for matrix retainers

- 3070-5
- 3071
- 3072
- 3073-1
- 3073-2
- 3073-3

for matrix retainers

- 3070-6
- 3070-7
- 3071
- 3072
- 3073-1
- 3073-2
- 3073-3

for matrix retainers

- 3070-7
- 3071
- 3072
- 3073-1
- 3073-2
- 3073-3



5 mm x 100 cm
3082-5



6 mm x 100 cm
3082-6



7 mm x 100 cm
3082-7

Tofflemire

12 pcs / pack



1
Tofflemire
3081-1



2
Tofflemire
3081-2



3
Tofflemire
3081-3

12 pcs / pack

assorted:
3081-1
3081-2
3081-3



Tofflemire
3081

Composite instruments

Molars and Pre-molars

Molars, Pre-molars, Incisors and Canines

Composite instruments

Molars, Pre-molars, Incisors and Canines

Molars and Pre-molars



Asa Com 1/1B
5112-3
Asa60

Asa Com 2/2B
0704-16D2
Asa60

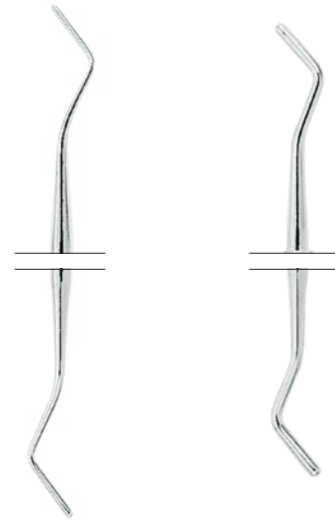

Asa Com 3/3B
1203-1
Asa60

Asa Com 4/4B
1203-3
Asa60

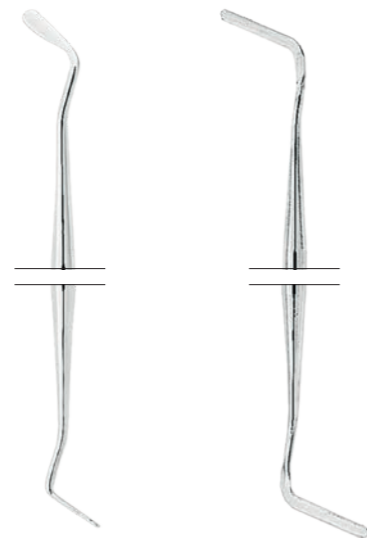

Asa Com 5/5B
1219-179
Asa60

Asa Com 6/6B
1504-2
Asa60

Asa Com 1/1B

small and large tips ideal for filling and modeling occlusal anatomy in posterior areas
Universal

Asa Com 2/2B

same tips with different angle to model occlusal sulcus in hard to reach posterior areas
Universal

Asa Com 3/3B

highly versatile condenser with small and large semi-spherical tip, for placement and contouring
valid for: class 1, 2, 3, 4 and 5

Asa Com 4/4B

highly versatile condenser with small and large semi-spherical tip, for placement and contouring
valid for: class 1, 2, 3, 4 and 5

Asa Com 5/5B

versatile instrument for application, layering and modeling of composite, with opposite (lateral and frontal) blades
valid for: class 1, 2, 3, 4 and 5

Asa Com 6/6B

filling and shaping instrument, ideal for composite definition in mesial and distal areas
valid for: class 2, 3 and 5



Asa Com 7/7B
5153-1
● Alu80



Asa Com 8/8B
1220-B2
Asa60



Asa Com 9/9B
1201-1L
Asa60



Asa Com 10/10B
1201-2L
Asa60



Asa Com 11/11B
1401-1
Asa60



Asa Com 12/12B
1213-H3
Asa60

Asa Com 7/7B

versatile instrument ideal for gingival areas but also suitable for medial and distal definition
valid for: class 1, 2, 3, 4 and 5

Asa Com 8/8B

combination of small tip for occlusal anatomy modeling and narrow paddle for labial areas
Universal

Asa Com 9/9B

small and large, flat tip condenser
valid for: class 1, 2, 3, 4 and 5

Asa Com 10/10B

small and large, flat tip condenser
valid for: class 1, 2, 3, 4 and 5

Asa Com 11/11B

small and large tip condenser
Universal

Asa Com 12/12B

versatile condenser with opposite (lateral and frontal) tips
Universal

Composite instruments

Molars, Pre-molars, Incisors and Canines

Magic Color MC composite instruments

Composite instruments



Asa Com 13/13B 5112-4 Asa60
Asa Com 15/15B 1210-3 Asa60

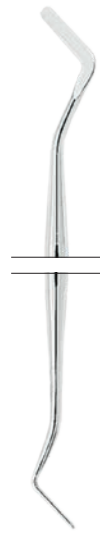

Asa Com 14/14B 1210-1 Asa60



Asa Com 13/13B
 opposing blades instrument
 for composite contouring,
 removal and modeling
 Universal

Asa Com 14/14B
 versatile instrument
 composite application,
 layering and modeling,
 with opposite (lateral and
 frontal) tips
 Universal

Asa Com 15/15B
 versatile instrument
 composite application,
 layering and modeling,
 with opposite (lateral and
 frontal) tips
 valid for: class 2, 3, 4 and 5



MC1510-1D ● Magic Color MC
MC1510-2D ● Magic Color MC
MC1510-3D ● Magic Color MC
MC1510-4D ● Magic Color MC
MC1510-5D ○ Magic Color MC



S1222-7

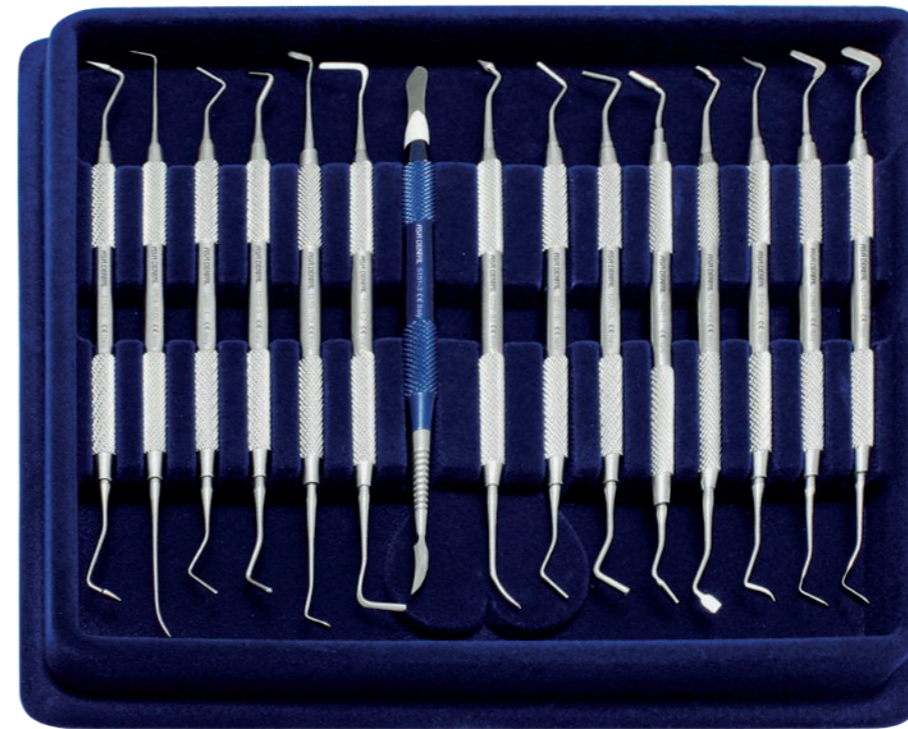

S1222-15

Asa Com 1/1B	5112-3
Asa Com 2/2B	0704-16D2
Asa Com 3/3B	1203-1
Asa Com 4/4B	1203-3
Asa Com 5/5B	1219-179
Asa Com 6/6B	1504-2
Asa Com 7/7B	5153-1

Asa Com 1/1B	5112-3
Asa Com 2/2B	0704-16D2
Asa Com 3/3B	1203-1
Asa Com 4/4B	1203-3
Asa Com 5/5B	1219-179
Asa Com 6/6B	1504-2
Asa Com 7/7B	5153-1
Asa Com 8/8B	1220-B2
Asa Com 9/9B	1201-1L
Asa Com 10/10B	1201-2L
Asa Com 11/11B	1401-1
Asa Com 12/12B	1213-H3
Asa Com 13/13B	5112-4
Asa Com 14/14B	1210-1
Asa Com 15/15B	1210-3

PERIODONTAL

MADE IN ITALY

THE CUTTING EDGE

At Asa Dental we know that every professional cares the most about two things: clients' satisfaction and time. Hence, manufacturing instruments that guarantee the best results in the shortest time have become our number one motivator. We use cutting edge technologies to obtain cutting edge periodontal instruments, and we explore any possible design to give them the necessary shape, handle and size options. Sharp, durable and resilient to resist time and use.

- G3 Pocket Probes
- G4 Curettes and Scalers
- G11 Gracey curettes
- G14 Scalers
- G16 Periosteals and Elevators
- G20 Bone curettes
- G22 Files
- G24 Gingivectomy knives
- G26 Chisels and Gouges
- G29 Mallets
- G30 Accessories
- G31 Pocket markers
- G32 Grinding stones
- G34 Kits

Handle options

SINGLE END

Asa35
(stainless steel)
ø 3.5 mm

Asa60
(stainless steel)
ø 6.0 mm

Leonardo ML
(stainless steel)
ø 7.0 mm

● Magic Color MC
(aluminum core and
non-slip plastic)
ø 8.0 / 10.5 mm

DOUBLE END

Asa60
(stainless steel)
ø 6.0 mm

Asa Light MV
(stainless steel, hollow)
ø 8.0 mm

Leonardo ML
(stainless steel)
ø 7.0 mm

Leonardo Light LV
(stainless steel)
ø 10.0 mm

Octagonal
(stainless steel)
ø 5.5 mm

Perfection
(stainless steel)
ø 8.0 mm

● Magic Color MC
(aluminum core and
non-slip plastic)
ø 8.0 / 10.5 mm

How to use

- CP-12 → pattern + scientific name
- MC0702-12 → Asa Dental code
- Magic Color MC → handle option

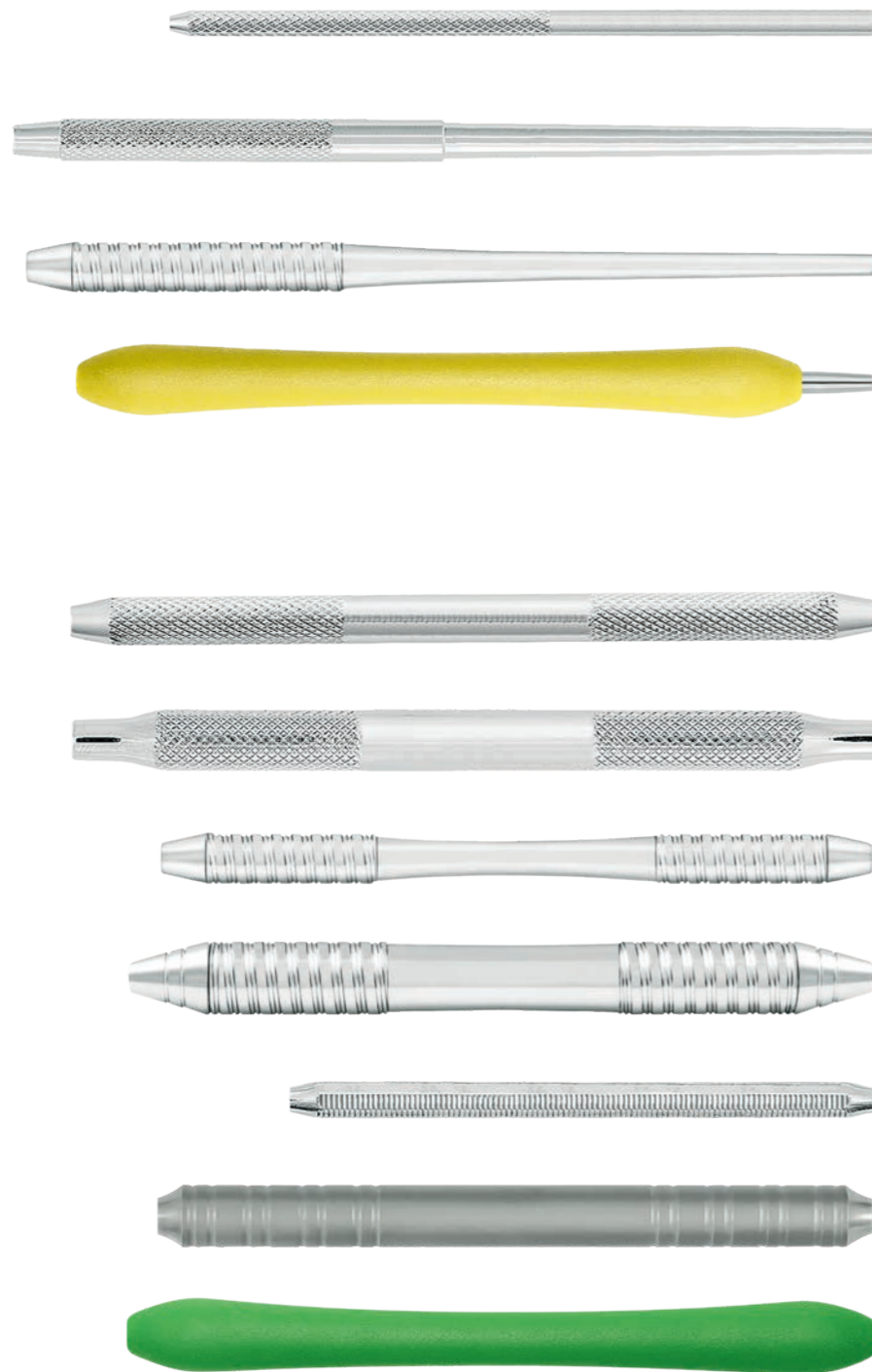

Periodontal pocket Probes



Easy and fast to clean, they guarantee maximum precision. Depth markings resist to the most stressing conditions, including temperature and chemicals, to maintain performance over time and use. The ergonomic handle is designed to transform the instrument in the natural extension of your hand.

- New marking process
- Laser system marking
- No more paint peeling off
- Permanent marking
- Antiglare, low depth marking
- Maximum tip resistance against breaking

	3 6 8 11	3 6 9 12	3.5 5.5 8.5 11.5	1 2 3 4 5 6 7 8 9 10 11 12 13 14 15
	CP-11 0702L-11 Asa60	CP-12 0702L-12 Asa60 ● Magic Color MC	CP-12S 0702L-12S Asa60	CP-15 0702L-15 Asa60
	1 2 3 5 7 8 9 10	1 2 3 5 7 8 9 10	1 2 3 5 7 8 9 10	1 2 3 5 7 8 9 10 FLAT TIP
	Williams 0703L-1 Asa60	Merrit A 0703L-2 Asa60	Merrit B 0703L-3 Asa60	Goldman-Fox 0703L-4 Asa60
	3 6 8	1 2 3 5 7 8 9 10	3.5 6 9 12	1 2 3 5 7 8 9 10 12 14
CP-C 0702-C Asa35	University of Michigan 0703L-5 Asa60	26 G 0703L-6 Asa60	OMS Novatech ML0702-OMS Leonardo ML MC0702-OMS ● Magic Color MC	Williams ML0703-14 Leonardo ML MC0703-14 ● Magic Color MC

Curettes and Scalers

set of 7



02 · 2RL · 4RL · 14 · 412 · 414 · Z
S1806
Asa60
02 · 2RL · 4RL · 14 · 412 · 414 · Z
SMV1806
Asa Light MV



HU 1/2
1806-02
Asa60
MV1806-02
Asa Light MV

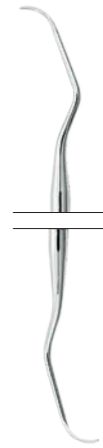

2R/2L Columbia
1806-2RL
Asa60
MV1806-2RL
Asa Light MV
ML1806-2RL
Leonardo ML
MC1806-2RL
● Magic Color MC



411/412 Columbia
1806-412
Asa60
MV1806-412
Asa Light MV

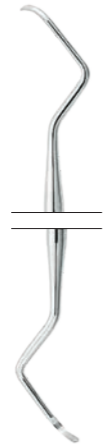

4R/4L Columbia
1806-4RL
Asa60
MV1806-4RL
Asa Light MV
ML1806-4RL
Leonardo ML
MC1806-4RL
● Magic Color MC

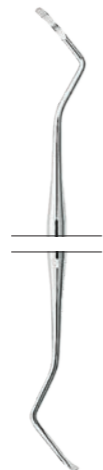

413/414 Columbia
1806-414
Asa60
MV1806-414
Asa Light MV

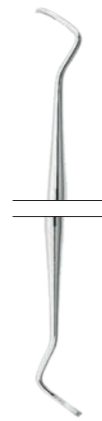

13/14 Columbia
1806-14
Asa60
MV1806-14
Asa Light MV
ML1806-14
Leonardo ML
MC1806-14
● Magic Color MC



Zerfing-Chisel
1820-Z
Asa60



HU 1/2 Langer
1805-02
Asa60
MV1805-02
Asa Light MV



3/4 Langer
1805-04
Asa60
MV1805-04
Asa Light MV



5/6 Barnhart
1821-06
Asa60

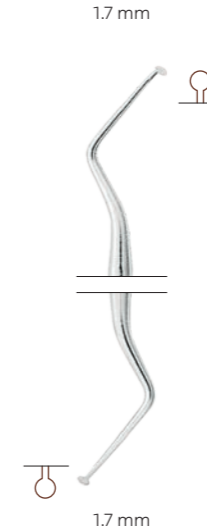

1 De Marco
1808-1
Asa60



13/14 Indiana University anterior
1824-14
Asa60
MV1824-14
Asa Light MV

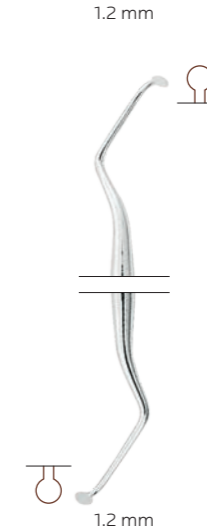

2 De Marco
1808-2
Asa60

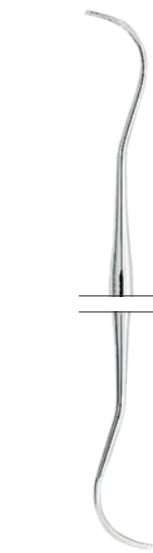

17/18 Indiana University posterior
1824-18
Asa60
MV1824-18
Asa Light MV



1/2 Barnhart
1821-02
Asa60



ME-1 (10/11)
1822-ME1
Asa60



3/4 Rule (23/24)
1823-R04
Asa60

Curettes and Scalers

set of 7



1 · 2 · 3 · 4 · 5 · 6 · 21

S1809

Asa60

1 · 2 · 3 · 4 · 5 · 6 · 21

SMV1809

Asa Light MV



1 Goldman-Fox
1809-1
Asa60
MV1809-1
Asa Light MV
ML1809-1
Leonardo ML

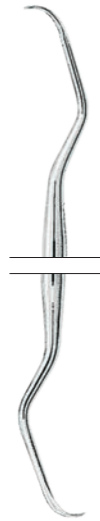

2 Goldman-Fox
1809-2
Asa60
MV1809-2
Asa Light MV
ML1809-2
Leonardo ML

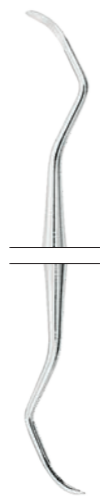

3 Goldman-Fox
1809-3
Asa60
MV1809-3
Asa Light MV
ML1809-3
Leonardo ML

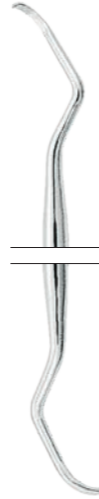

4 Goldman-Fox
1809-4
Asa60
MV1809-4
Asa Light MV
ML1809-4
Leonardo ML

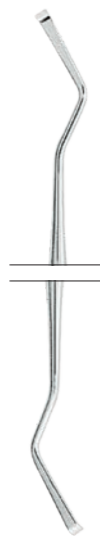

5 Goldman-Fox
1809-5
Asa60
MV1809-5
Asa Light MV
ML1809-5
Leonardo ML

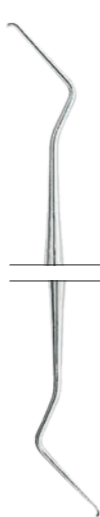

6 Goldman-Fox
1809-6
Asa60
MV1809-6
Asa Light MV



21 Goldman-Fox
1809-21
Asa60
MV1809-21
Asa Light MV
ML1809-21
Leonardo ML

Curettes and Scalers



11/12 Mc Call
1825-12
Asa60
MV1825-12
Asa Light MV

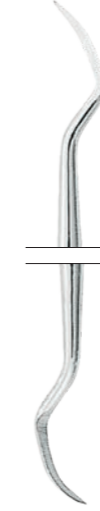

11A/12A Mc Call
1825-12A
Asa60



13S/14S Mc Call
1825-14S
Asa60
MV1825-14S
Asa Light MV
ML1825-14S
Leonardo ML

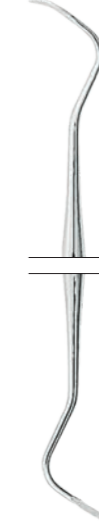

13/14 Mc Call
1825-14
Asa60
MV1825-14
Asa Light MV



17S/18S Mc Call
1825-18S
Asa60
MV1825-18S
Asa Light MV



19/20 Mc Call
1825-20
Asa60
MV1825-20
Asa Light MV

Curettes and Scalers



2/3 Taylor
1826-T03
Asa60
MV1826-T03
Asa Light MV
ML1826-T03
Leonardo ML
LV1826-T03
Leonardo Light LV

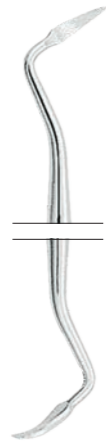

204
1827-204
Asa60

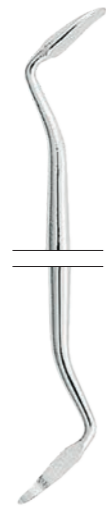

6 Crane-Kaplan
1829-CK6
Asa60
MV1829-CK6
Asa Light MV
ML1829-CK6
Leonardo ML
LV1829-CK6
Leonardo Light LV

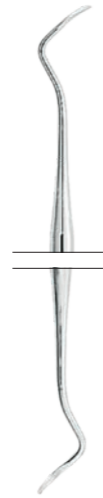

204S
1827-204S
Asa60
MV1827-204S
Asa Light MV
ML1827-204S
Leonardo ML
LV1827-204S
Leonardo Light LV
MC1827-204S
● Magic Color MC

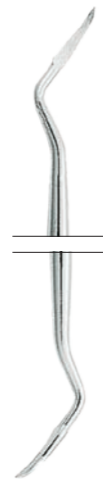

6S Mini Crane-Kaplan
1829-CK6S
Asa60
ML1829-CK6S
Leonardo ML
MC1829-CK6S
● Magic Color MC



7/8 Younger-Good
1830-YG08
Asa60
MV1830-YG08
Asa Light MV
ML1830-YG08
Leonardo ML



31/32 Jacquette
1831-32
Asa60
MV1831-32
Asa Light MV



30/33 Jacquette
1831-33
Asa60
MV1831-33
Asa Light MV



34/35 Jacquette
1831-35
Asa60
MV1831-35
Asa Light MV

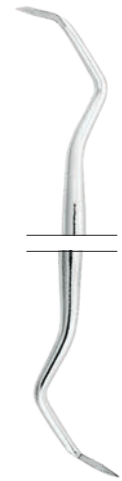

37/38 Jacquette
1831-38
Asa60
MV1831-38
Asa Light MV

1831-32



Curettes and Scalers

Gracey application chart

- Anterior sextants of teeth
 - GRA 1/2** Incisors and Canines
 - GRA 3/4** Incisors and Canines
 - GRA 5/6** Anterior and Premolars
- Buccal and lingual surfaces of posterior teeth
 - GRA 7/8** Premolars and Molars
 - GRA 9/10** Premolars and Molars
- Mesial surfaces of posterior teeth
 - GRA 11/12** Premolars and Molars
 - GRA 15/16** Premolars and Molars
- Distal surfaces of posterior teeth
 - GRA 13/14** Molars
 - GRA 17/18** Molars

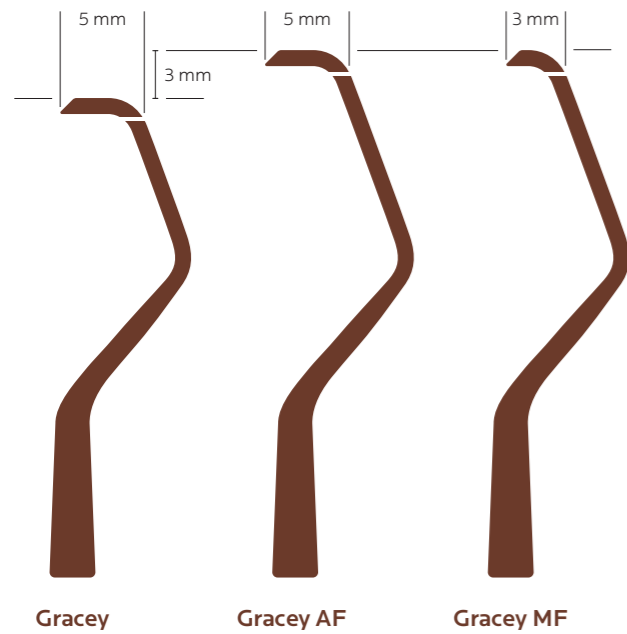
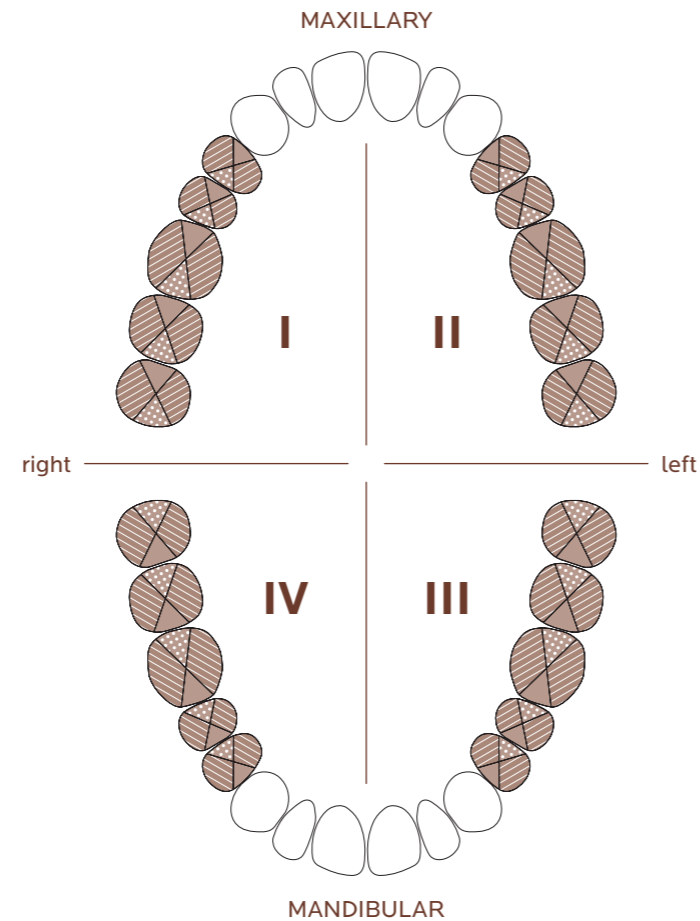

- Magic Color handles
- GRA 1/2
 - GRA 3/4
 - GRA 5/6
 - GRA 7/8
 - GRA 9/10
 - GRA 11/12
 - GRA 13/14
 - GRA 15/16
 - GRA 17/18

Gracey cures

	3/4 Gracey 1807-04 Asa60 MV1807-04 Asa Light MV ML1807-04 Leonardo ML LV1807-04 Leonardo Light LV MC1807-04 ● Magic Color MC	5/6 Gracey 1807-06 Asa60 MV1807-06 Asa Light MV ML1807-06 Leonardo ML LV1807-06 Leonardo Light LV MC1807-06 ● Magic Color MC	7/8 Gracey 1807-08 Asa60 MV1807-08 Asa Light MV ML1807-08 Leonardo ML LV1807-08 Leonardo Light LV MC1807-08 ● Magic Color MC	9/10 Gracey 1807-10 Asa60 MV1807-10 Asa Light MV ML1807-10 Leonardo ML LV1807-10 Leonardo Light LV MC1807-10 ● Magic Color MC	11/12 Gracey 1807-12 Asa60 MV1807-12 Asa Light MV ML1807-12 Leonardo ML LV1807-12 Leonardo Light LV MC1807-12 ● Magic Color MC
	1/2 Gracey 1807-02 Asa60 MV1807-02 Asa Light MV ML1807-02 Leonardo ML LV1807-02 Leonardo Light LV MC1807-02 ● Magic Color MC	13/14 Gracey 1807-14 Asa60 MV1807-14 Asa Light MV ML1807-14 Leonardo ML LV1807-14 Leonardo Light LV MC1807-14 ● Magic Color MC	15/16 Gracey 1807-16 Asa60 ML1807-16 Leonardo ML LV1807-16 Leonardo Light LV MC1807-16 ● Magic Color MC	17/18 Gracey 1807-18 Asa60 ML1807-18 Leonardo ML LV1807-18 Leonardo Light LV MC1807-18 ● Magic Color MC	11/14 Gracey Mesial-Distal 1807-11MD Asa60 MV1807-11MD Asa Light MV ML1807-11MD Leonardo ML LV1807-11MD Leonardo Light LV
					12/13 Gracey Mesial-Distal 1807-13MD Asa60 MV1807-13MD Asa Light MV ML1807-13MD Leonardo ML LV1807-13MD Leonardo Light LV

Gracey curettes - AF



1/2 Gracey
1807-02AF
Asa60
ML1807-02AF
Leonardo ML
LV1807-02AF
Leonardo Light LV

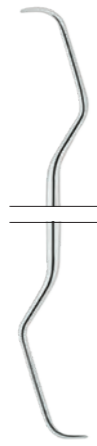

3/4 Gracey
1807-04AF
Asa60
ML1807-04AF
Leonardo ML
LV1807-04AF
Leonardo Light LV

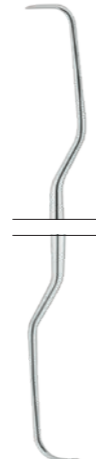

5/6 Gracey
1807-06AF
Asa60
ML1807-06AF
Leonardo ML
LV1807-06AF
Leonardo Light LV

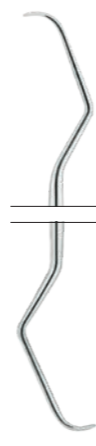

7/8 Gracey
1807-08AF
Asa60
ML1807-08AF
Leonardo ML
LV1807-08AF
Leonardo Light LV

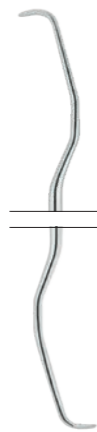

11/12 Gracey
1807-12AF
Asa60
ML1807-12AF
Leonardo ML
LV1807-12AF
Leonardo Light LV



13/14 Gracey
1807-14AF
Asa60
ML1807-14AF
Leonardo ML
LV1807-14AF
Leonardo Light LV



15/16 Gracey
1807-16AF
Asa60
ML1807-16AF
Leonardo ML
LV1807-16AF
Leonardo Light LV

Gracey curettes - MF



1/2 Gracey
1807-02MF
Asa60
ML1807-02MF
Leonardo ML
LV1807-02MF
Leonardo Light LV
MC1807-02MF
● Magic Color MC



3/4 Gracey
1807-04MF
Asa60
ML1807-04MF
Leonardo ML
LV1807-04MF
Leonardo Light LV
MC1807-04MF
● Magic Color MC

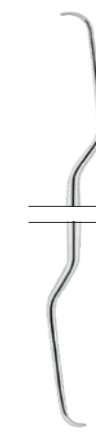

5/6 Gracey
1807-06MF
Asa60
ML1807-06MF
Leonardo ML
LV1807-06MF
Leonardo Light LV
MC1807-06MF
● Magic Color MC



7/8 Gracey
1807-08MF
Asa60
ML1807-08MF
Leonardo ML
LV1807-08MF
Leonardo Light LV
MC1807-08MF
● Magic Color MC



11/12 Gracey
1807-12MF
Asa60
ML1807-12MF
Leonardo ML
LV1807-12MF
Leonardo Light LV
MC1807-12MF
● Magic Color MC



13/14 Gracey
1807-14MF
Asa60
ML1807-14MF
Leonardo ML
LV1807-14MF
Leonardo Light LV
MC1807-14MF
● Magic Color MC



15/16 Gracey
1807-16MF
Asa60
ML1807-16MF
Leonardo ML
LV1807-16MF
Leonardo Light LV
MC1807-16MF
● Magic Color MC

Scalers

Scalers



U15 Towner
1903
Asa60
ML1903
Leonardo ML

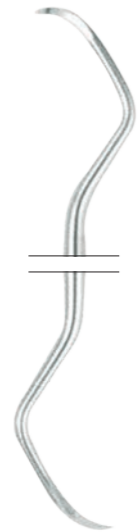

M23
Universal Scaler
1900-M23
Asa60
ML1900-M23
Leonardo ML

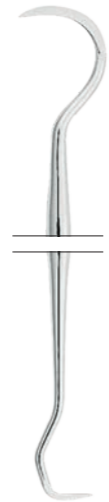

U15/33
Towner Jacquette
1902-1
Asa60
MV1902-1
Asa Light MV
ML1902-1
Leonardo ML
MC1902-1
● Magic Color MC

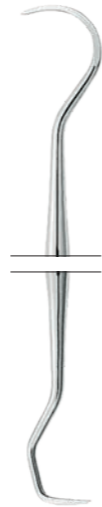

U15/30
Towner Jacquette
1902-2
Asa60
MV1902-2
Asa Light MV



H5/33
1904-H5
Asa60
MV1904-H5
Asa Light MV

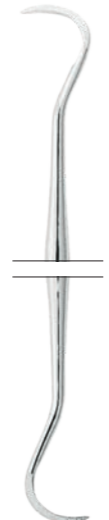

H6/H7
1904-H6
Asa60
MV1904-H6
Asa Light MV

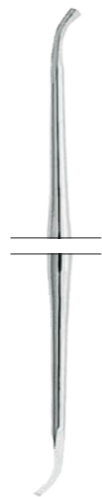

1/2
1905-02
Asa60
MV1905-02
Asa Light MV



1
1901-1
Asa60



1L
left
1900-1L
Asa60



1R
right
1900-1R
Asa60



2L
left
1900-2L
Asa60



2R
right
1900-2R
Asa60



H5 Hygienist
1909-H5
Asa60



H6 Hygienist
1909-H6
Asa60



H7 Hygienist
1909-H7
Asa60



33
1906-33
Asa60



1 Jacquette
ML1906-1
Leonardo ML



2 Jacquette
ML1906-2
Leonardo ML



3 Jacquette
ML1906-3
Leonardo ML

Periosteals and Elevators

Periosteals and Elevators

3 mm
LANCE TIP



3 mm
ROUNDED TIP

Buser
PR1850-M
Perfection



GF Goldman-Fox
MV1850-GF
Asa Light MV

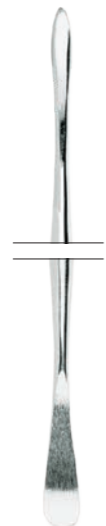

Beale
5114-1
Octagonal

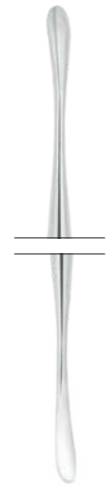

M7 Molt
MV1850-M7
Asa Light MV



9A Allen
MV1850-9A
Asa Light MV

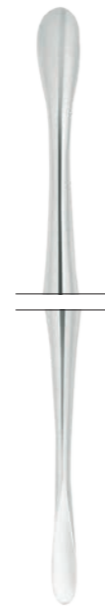

M8 Molt
MV1850-M8
Asa Light MV

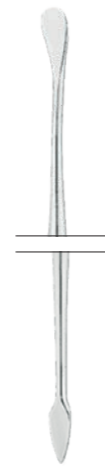

2 Hourigan
MV1851-2
Asa Light MV



M9 Molt
MV1850-M9
Asa Light MV



PR3 Prichard
MV 1851-PR3
Asa Light MV



Partsch
14.5 cm
1849-1
Asa60



1 Hopkins
MV1852-1
Asa Light MV



3 Mead
MV1854-3
Asa Light MV



2 Hopkins
MV1852-2
Asa Light MV



15 Freer
MV1853-15
Asa Light MV



16 Freer
MV1853-16
Asa Light MV

Periosteals and Elevators

Periosteals and Elevators

2 mm



2.5 mm

17 cm
PR1850-1
Perfection



22 Seldin
retractor
1855-22



23 Seldin
retractor
1855-23



König
15.5 cm
1858-1



Williger
17 cm
1856-1



Williger
16 cm
1856-2



Williger
16 cm
1857-1



Williger
13 cm
1857-2

Bone currettes

1 Hemingway
2000-1
Asa60
MV2000-1
Asa Light MV
ML2000-1
Leonardo ML
MC2000-1
● Magic Color MC

2 Hemingway
2000-2
Asa60
MV 2000-2
Asa Light MV
ML2000-2
Leonardo ML
MC2000-2
● Magic Color MC

3 Hemingway
2000-3
Asa60
MV 2000-3
Asa Light MV
ML2000-3
Leonardo ML
MC2000-3
● Magic Color MC

4 Hemingway
2000-4
Asa60
MV2000-4
Asa Light MV
ML2000-4
Leonardo ML

85 Lucas
2001-85
Asa60
MV2001-85
Asa Light MV
ML2001-85
Leonardo ML

86 Lucas
2001-86
Asa60
MV2001-86
Asa Light MV
ML2001-86
Leonardo ML

87 Lucas
2001-87
Asa60
MV2001-87
Asa Light MV
ML2001-87
Leonardo ML

88 Lucas
2001-88
Asa60
MV2001-88
Asa Light MV
ML2001-88
Leonardo ML

Bone currettes

00/0 Williger
14 cm
2015-00

1/2 Williger
14 cm
2015-1

00/0
14 cm
2016-00

1/2
14 cm
2016-1

2
U.S.A. model
16 cm
2013-2

2R
U.S.A. model
16 cm
2013-2R

2L
U.S.A. model
16 cm
2013-2L

Files

Bone files



3/7 Hirschfeld
1810-07
Asa60
MV1810-07
Asa Light MV

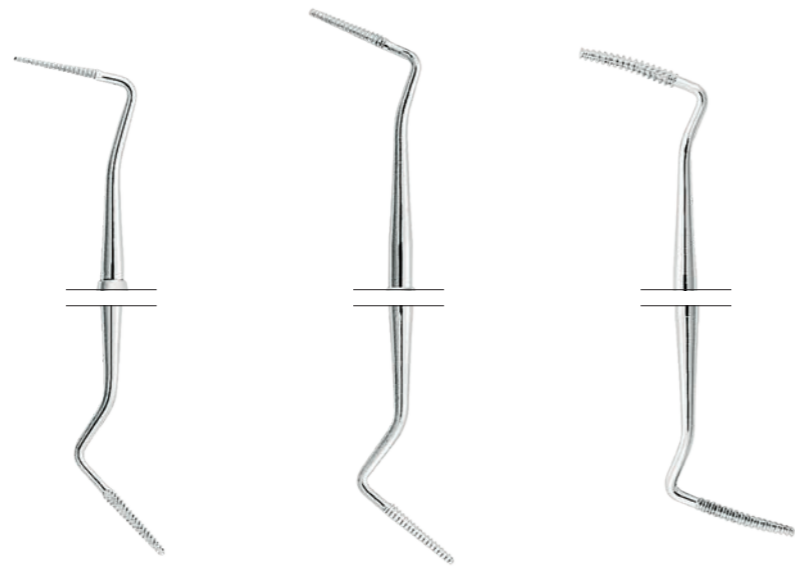

1S/2S Sugarman
1812-02S
Asa60
MV1812-02S
Asa Light MV

3S/4S Sugarman
1812-04S
Asa60
MV1812-04S
Asa Light MV

9/10 Schluger
1813-10
Asa60
MV1813-10
Asa Light MV

1812-04S



1 Polokoff
2003-1



33
2004-33



12 Howard
2008-12



45 Miller
2005-45



12A
2007-12A



64 Miller
2005-64



12CA
2007-12CA



10
2006-10

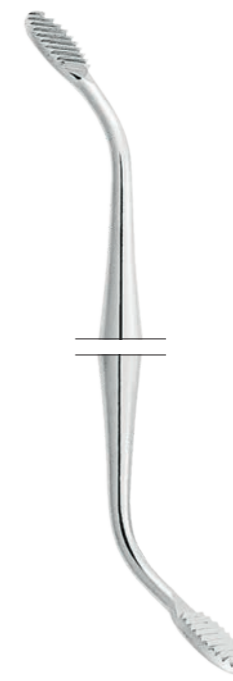

1 Wahl
MV2002-1
Asa Light MV

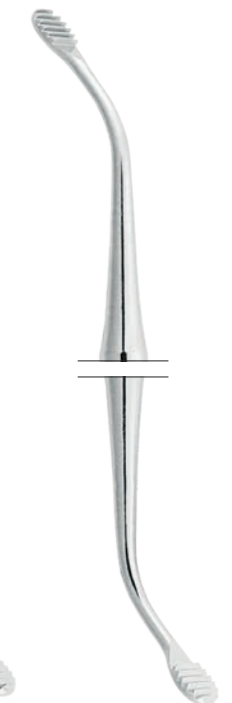

2 Wahl
MV2002-2
Asa Light MV

Gingivectomy knives

Gingivectomy knives



1 (15K) Kirkland
1803-1
Asa60



2 (16K) Kirkland
1803-2
Asa60



1 Orban
1804-1
Asa60



2 Orban
1804-2
Asa60

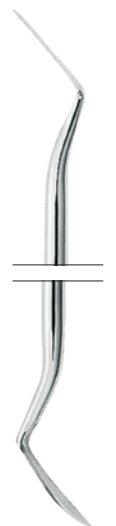

1/2 (15K/16K) Kirkland
1803-D
Asa60
MV1803-D
Asa Light MV
ML1803-D
Leonardo ML

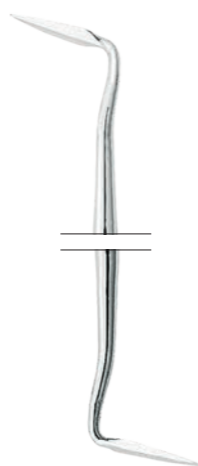

5/6 Buck
1816-06
Asa60
ML1816-06
Leonardo ML



1/2 Orban
1804-D
Asa60
MV1804-D
Asa Light MV
ML1804-D
Leonardo ML



7 Goldman-Fox
1815-7
Asa60

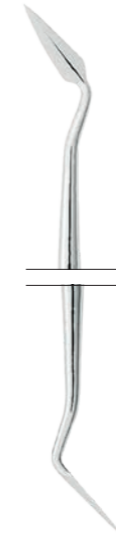

8 Goldman-Fox
1815-8
Asa60

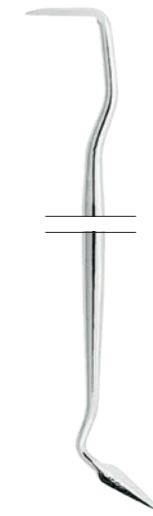

9 Goldman-Fox
1815-9
Asa60

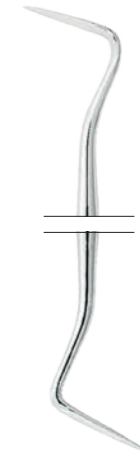

11 Goldman-Fox
1815-11
Asa60

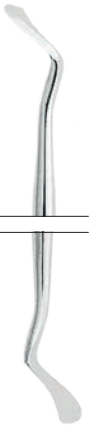

3/4 Buck
1816-04
Asa60



1/2 Sanders
1817-02
Asa60

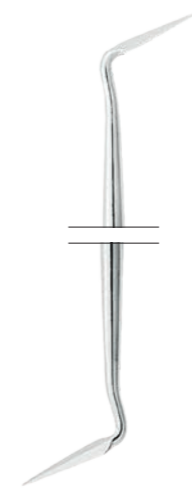

4/5 Sanders
1817-05
Asa60



19/20
(University of
South California)
USC Towner
1818-20
Asa60



CK3 Crane-Kaplan
1819-CK3
Asa60

Chisels

Bone chisels and gouges



3 Ochsenbein
1802-3
Asa60
MV1802-3
Asa Light MV

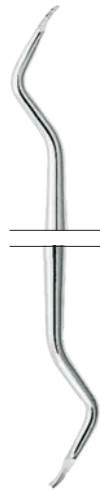

4 Ochsenbein
1802-4
Asa60
MV1802-4
Asa Light MV

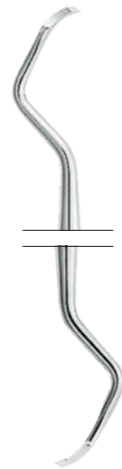

36/37 Rhodes back-action
1811-37
Asa60
MV1811-37
Asa Light MV



1 TG Chisel
1801-1
Asa60



2 TG Chisel
1801-2
Asa60



1/2 TG Chisel
1801-D
Asa60
MV1801-D
Asa Light MV



1 Ochsenbein
1800-1



2 Ochsenbein
1800-2



6 Gardner
1832-6



1 Gardner
1832-1



1W Wakefield
1833-1W



2 Gardner
1832-2



2W Wakefield
1833-2W



5 Gardner
1832-5



3 Buckley
1834-3



5R Gardner
1832-5R

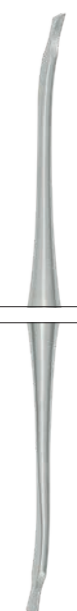

17 cm
PR1801-1
Perfection

Bone chisels and gouges

3 mm



Partsch
13.5 cm
1835-3

4 mm



Partsch
13.5 cm
1835-4

5 mm



Partsch
13.5 cm
1835-5

6 mm



Partsch
13.5 cm
1835-6

3 mm



Partsch
13.5 cm
1837-3

4 mm



Partsch
13.5 cm
1837-4

5 mm



Partsch
13.5 cm
1837-5

6 mm



Partsch
13.5 cm
1837-6

3 mm



Partsch
17 cm
1836-3

4 mm



Partsch
17 cm
1836-4

5 mm



Partsch
17 cm
1836-5

6 mm



Partsch
17 cm
1836-6

3 mm



Partsch
17 cm
1838-3

4 mm



Partsch
17 cm
1838-4

5 mm



Partsch
17 cm
1838-5

6 mm



Partsch
17 cm
1838-6

Mallets

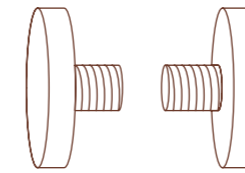

1881-R
#2 Teflon inserts
autoclavable
max 120°

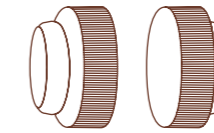

interchangeable
Ferozell
inserts



Partsch
19 cm
1880
lead filled



Mead
19.5 cm
1881



Mead
17 cm
1882



Vickers
19 cm
1884



Herbert
19 cm
1885

Periodontal instruments



Tomati
19 cm
0103-78
gum guillotine forceps



Goldman-Fox
10 cm
0103-60
bone/soft tissue nipper
small beaks for use in limited
access areas



Mini Friedman
12 cm
0103-25
bone rongeurs

Periodontal pocket markers



1 (Crane-Kaplan)
Goldman-Fox
15 cm
0650-1

2 (Crane-Kaplan)
Goldman-Fox
15 cm
0650-2

Grinding stones

beige India Corundum grinding stone, for sharpening and re-contouring of very blunt instruments

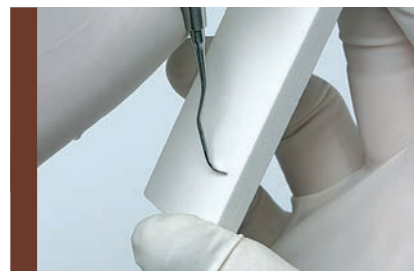
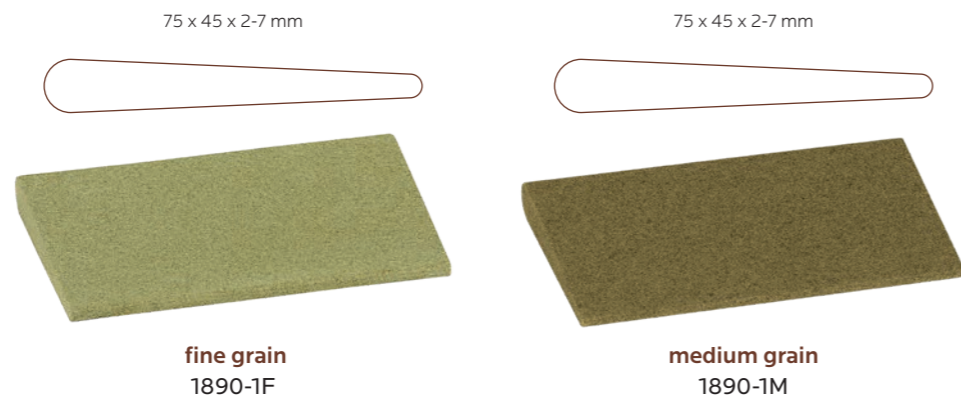

grey-white "Arkansas" grinding stone, for repeated sharpening of scalers and curettes as well as for finishing



white Super "Arkansas" grinding stone, for repeated sharpening of scalers and curettes as well as for finishing

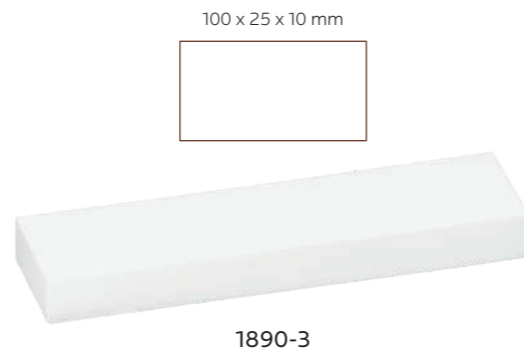

Arkansas grinding stone, convex file, for finishing

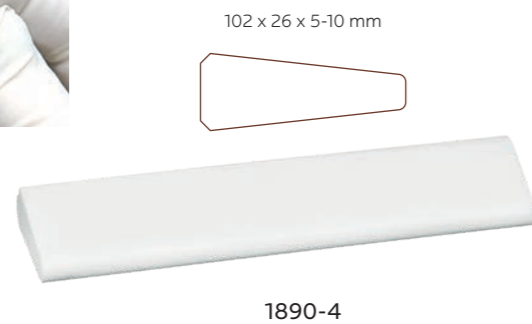

brown beige India Corundum grinding stone, round file, for deburring working ends



Grinding stones



grey-white "Arkansas" round section, grinding stone, for deburring working ends

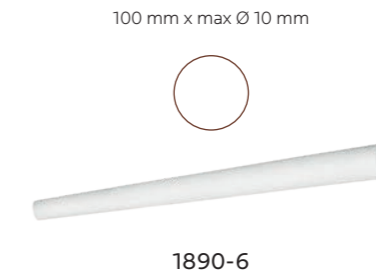

green silicon carbide grinding stone, tapered, for deburring working ends

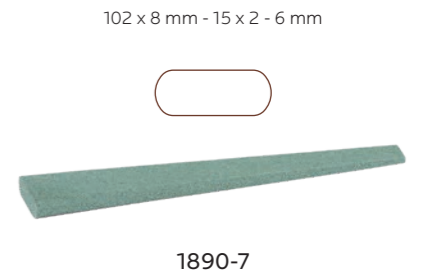

plexiglass test rod for checking sharpness of scalers and curettes
6 pcs / bag



S1890 case with grinding stones and oil



Asa Oil 40 ml 8001 oil for grinding stones, physiologically safe

Gracey curettes

set of 3



08 · 12 · 14
S1807-3
Asa60

set of 7



02 · 04 · 06 · 08 · 10 · 12 · 14
S1807
Asa60
SMV1807
Asa Light MV
SML1807
Leonardo ML
SLV1807
Leonardo Light LV
SMC1807
Magic Color MC

set of 3



08AF · 12AF · 14AF
S1807AF-3
Asa60

set of 7



02AF · 04AF · 06AF · 08AF
12AF · 14AF · 16AF
S1807AF
Asa60
SML1807AF
Leonardo ML
SLV1807AF
Leonardo Light LV

set of 3



08MF · 12MF · 14MF
S1807MF-3
Asa60

set of 7



02MF · 04MF · 06MF · 08MF
12MF · 14MF · 16MF
S1807MF
Asa60
SML1807MF
Leonardo ML
SLV1807MF
Leonardo Light LV

Periodontal instruments kit

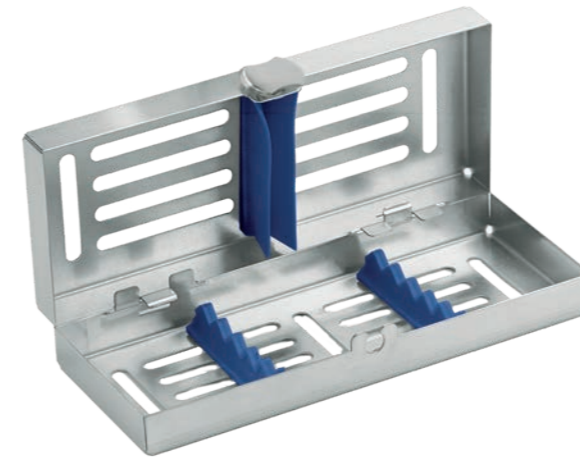

SMC1807-5



1/2	Gracey curette	MC1807-02
11/12	Gracey curette	MC1807-12
13/14	Gracey curette	MC1807-14
6S	mini Crane-Kaplan curette	MC1829-CK6S
U15/33	Towner-Jaquette scaler	MC1902-1
2	London-College cotton and dressing pliers	0601-2
	mini locking tray	2772-1



S1899

2	Goldman-Fox gum scissors curved, sawed edge	0304-2
1	Goldman-Fox periodontal pocket marker right side	0650-1
2	Goldman-Fox periodontal pocket marker -left side	0650-2
	Williams periodontal pocket probe	0703L-1
15K/16K	Kirkland gingivectomy knife	1803-D
1/2	Orban gingivectomy knife	1804-D
5/6	Gracey curette	1807-06
11/12	Gracey curette	1807-12
13/14	Gracey curette	1807-14
1	Goldman-Fox Universal scaler	1809-1
5/6	Buck gingivectomy knife	1816-06
13/14	Mc Call scaler	1825-14
6	Crane-Kaplan scaler	1829-CK6
U15	Towner scaler	1903
M9	Molt periosteal elevator	MV1850-M9

Periodontal instruments

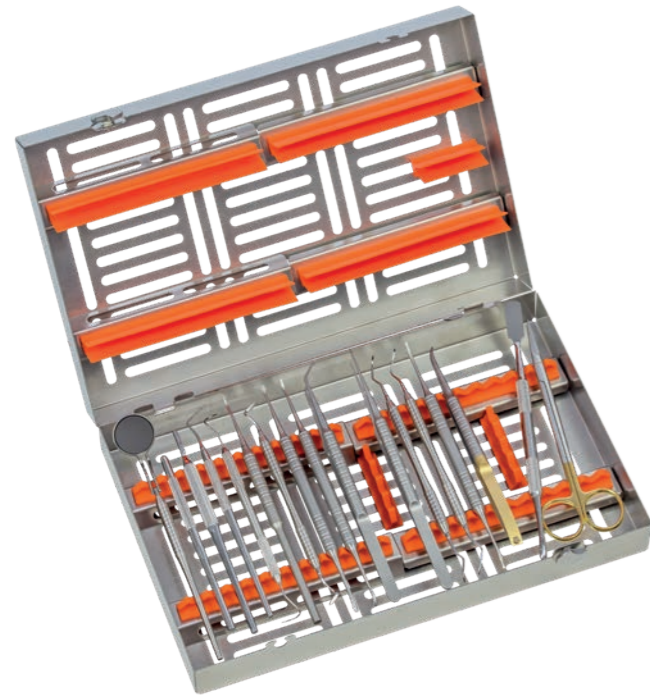

periodontal surgery kit
SPR2781-P

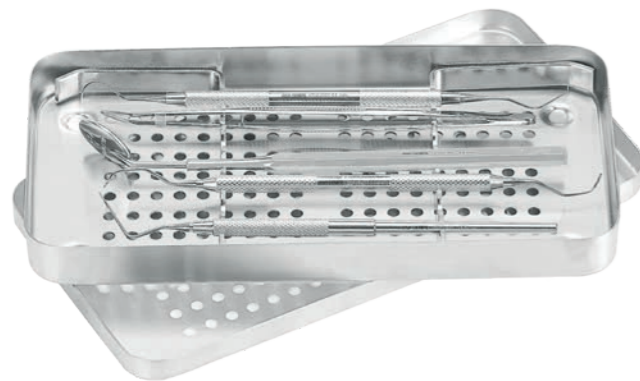

periodontal first examination kit
S0600-1



S3003-9

	mouth mirror handle	ML2101
5	double sided mouth mirrors	22305
CP-15	periodontal pocket probes	0702L-15
2N	double ended periodontal pocket probes	0708L-2N
	micro-blade holder	0365-1
5	scalpel handle and blade	0350-5
	exciser	PR1857-1
1/2	Orban gingivectomy knife	ML1804-D
PR3	Prichard periosteal periosteal elevator	MV1851-PR3
	papilla periosteal	PR1850-1
	tissue pliers	PR0625-3
	atraumatic tissue pliers	PR0632-1
2R/2L	periodontal instrument	ML1806-2RL
4R/4L	periodontal instrument	ML1806-4RL
	small bone chisel	PR1801-1
	Castroviejo needle holder	PR0460-15TC
2TC	gum scissors	0309-2TC
	sterilization cassette	2780-1A

	mouth mirrors handle	2102-IN
4	plane mouth mirror	2200-4
23/17	double-ended explorer	0704-23D1
1N	periodontal pocket probe	0708-1N
CP-12	periodontal pocket probe	0702L-12
2	London-College cotton and dressing pliers	0601-2
	instrument tray	S2702

M9	Molt periosteal	MV1850-M9
PR3	Prichard periosteal	MV1851-PR3
GF	Goldman-Fox periosteal	MV1850-GF
15K/16K	Kirkland knife	MV1803-D
	Mead mallet	1881
	Castroviejo needle holder	0446-14TC
	Mathieu needle holder	0435-17TC
3	scalpel handle	0350-3
	instrument tray	S2722-1

Periodontal instruments



S3003-11

Instrument Set realised according to the instructions of Prof. GUIDO GORACCI, senior Professor at the Department of Conservative Dentistry of "LA SAPIENZA", Rome University



S1800-23

3	scalpel handle	0350-3
	Sternberg retractor	2602-1
2	Goldman-Fox scissor	0304-2
M9	Molt periosteal	MV1850-M9
PR3	Prichard periosteal	MV1851-PR3
	Crile Wood needle holder	0415-15TC
1	Semken Taylor tissue plier	0631-1
23	explorer	0700-23
	mouth mirror handle	2102-IN
5	mouth mirror	2200-5
11	disposable blades (100 pcs)	0351-11
	instrument tray	S2722-1

36/37	Rhodes back-action file	1811-37
15K	Kirkland knife	1803-1
3/4	Buck knife	1816-04
7	Goldman-Fox knife	1815-7
1/2	Sanders knife	1817-02
HU 1/2	Langer curette	1805-02
5/6	Bernhart scaler	1821-06
3/4	Rule scaler	1823-R04
1	De Marco scaler	1808-1
5	Goldman-Fox scaler	1809-5
6	Goldman-Fox scaler	1809-6
11/12	McCall curette	1825-12
11A/12A	McCall curette	1825-12A
204	curette	1827-204
31/32	Jacquette curette	1831-32
H5/33	curette	1904-H5
3/7	Hirschfeld file	1810-07
1S/2S	Sugarman file	1812-02S
3S/4S	Sugarman file	1812-04S
1/2	chisel	1801-D
2	De Marco scaler	1808-2
2	Kirkland knife	1803-2
4	Ochsenbein bone chisel	1802-4
	instrument tray	S2720-2



ORTHODONTIC

MADE IN ITALY

MAKING THE RIGHT ADJUSTMENTS

A packed agenda that gets usually busier after school time, lots of young clients and many opportunities to positively contribute to healthier mouths and more pleasing appearances. This is your day as an orthodontist, a flow of 10 to 30 minutes appointments whose difficulty hugely varies, from routine alignments to complex detached braces or painful shifting of the archwire. Regardless of that, you need reliable instruments that can help you perform confidently and effectively. Asa Dental offers two different lines of products. Premium instruments are dedicated to professionals demanding unrivalled quality and ergonomics in every situation, with all the other pliers and cutters offering the ideal trade-off between performance and convenience. We believe in quality outcomes but we also believe in dental care accessible to everyone.

- H4 Cutters
- H10 Wire forming pliers
- H29 Utility pliers
- H34 Hand instruments
- H37 Prothesis boxes

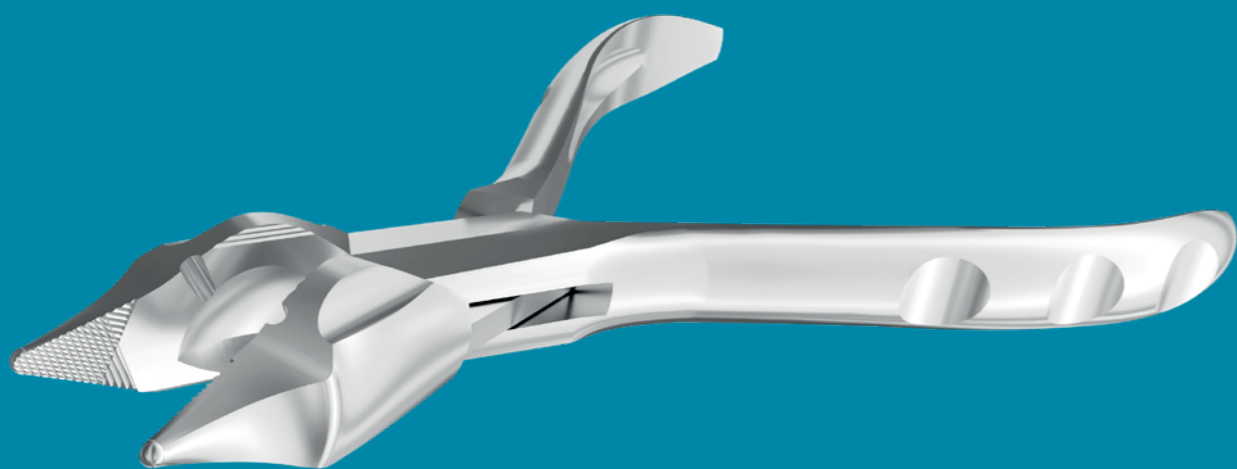

How to read this chapter



Premium orthodontic instrument



Premium orthodontic instrument with tungsten carbide (TC) inserts



standard instrument



standard instrument with tungsten carbide (TC) inserts

How to use

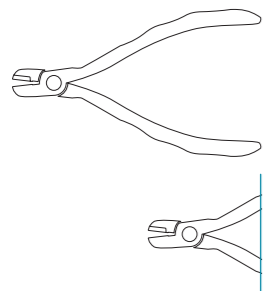

full view
Premium orthodontic instrument
code starts with 88

partial view
standard instrument
code starts with 58

when full and partial view
are in the one page
they refer to the same instrument,
premium and standard version

Technical drawing



drawings provide additional
information about shape

Cutters

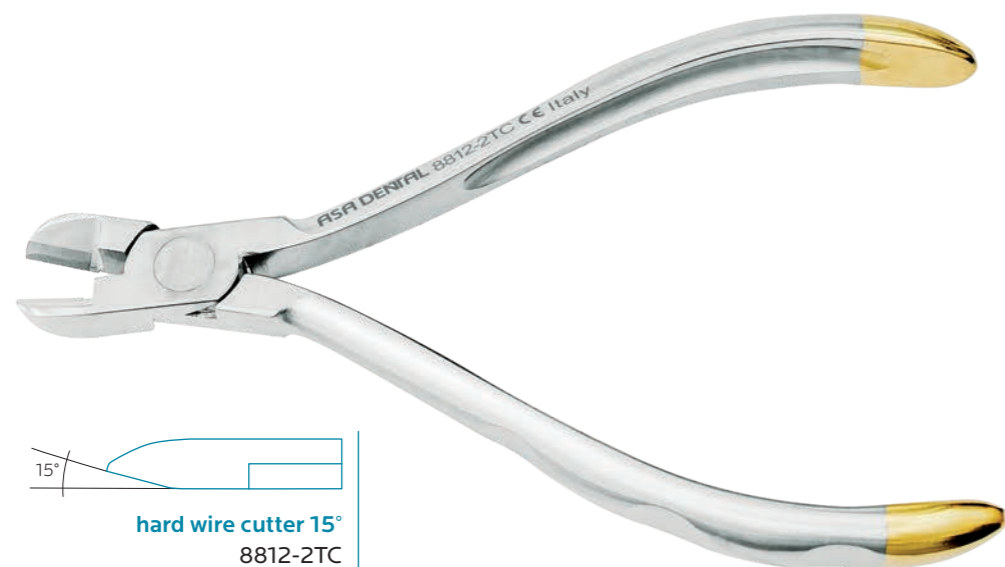

hard wire cutter 15°
8812-2TC

15° angle to better reach areas of difficult access.
Wire size:
max. 0.56 mm x 0.70 mm
(0.022" x 0.028")



universal distal-end-cutter no hold
8813-1TC

Mini universal distal end cutter, without safety hold.
Cuts flush to the bracket or buccal tube.
Wire size: max. 0.56 mm x 0.70 mm
(0.022" x 0.028")

Cutters



distal end flush cutter
8826-1TC

15° angle to better reach areas of difficult access.
Wire size: max. 0.56 mm x 0.70 mm
(0.022" x 0.028")



universal distal-end cutter
8814-1TC

Mini universal distal end cutter, with safety hold to ensure patient safety and comfort during use.
Wire size: max. 0.56 mm x 0.70 mm
(0.022" x 0.028")

Cutters

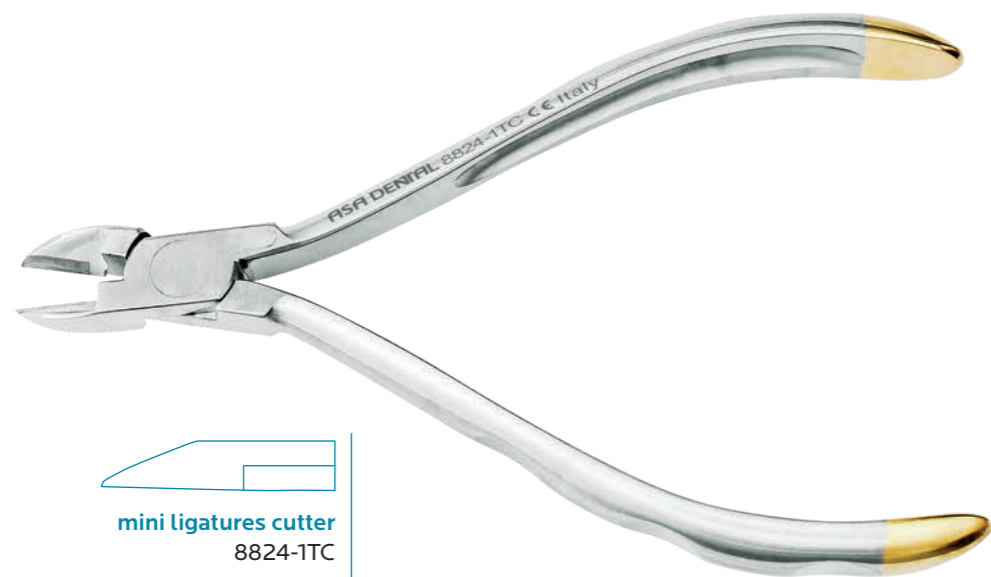

mini ligatures cutter
8824-1TC

Ligature cutter for hard wires, straight.
Slim profile to better access difficult areas.
Wire size: max. 0.40 mm (0.015")

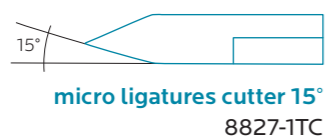
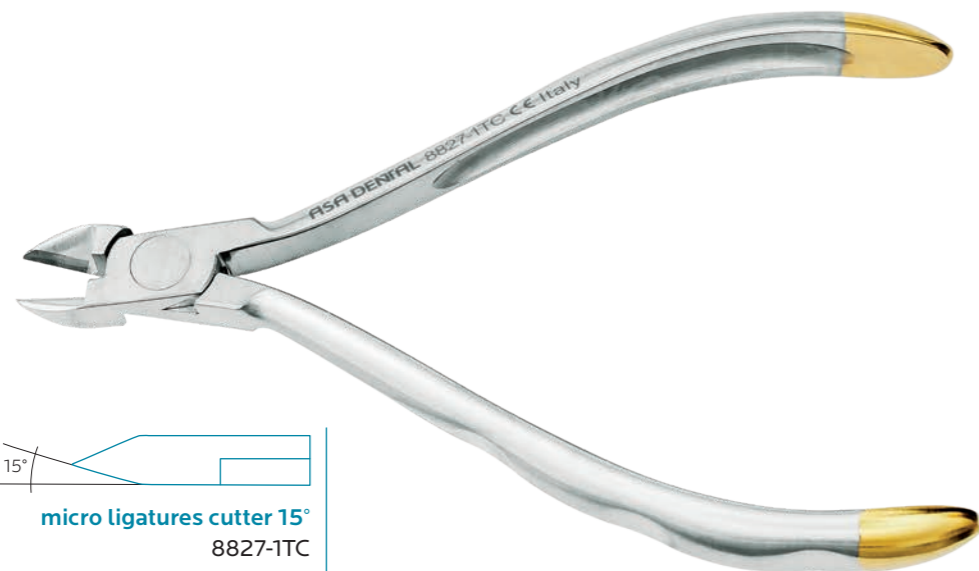

micro ligatures cutter 15°
8827-1TC

Ligature cutter for hard wires, 15° angle.
Ultra slim profile to reach
areas of difficult access.
Wire size: max. 0.40 mm (0.015")

Cutters

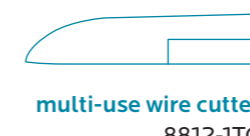
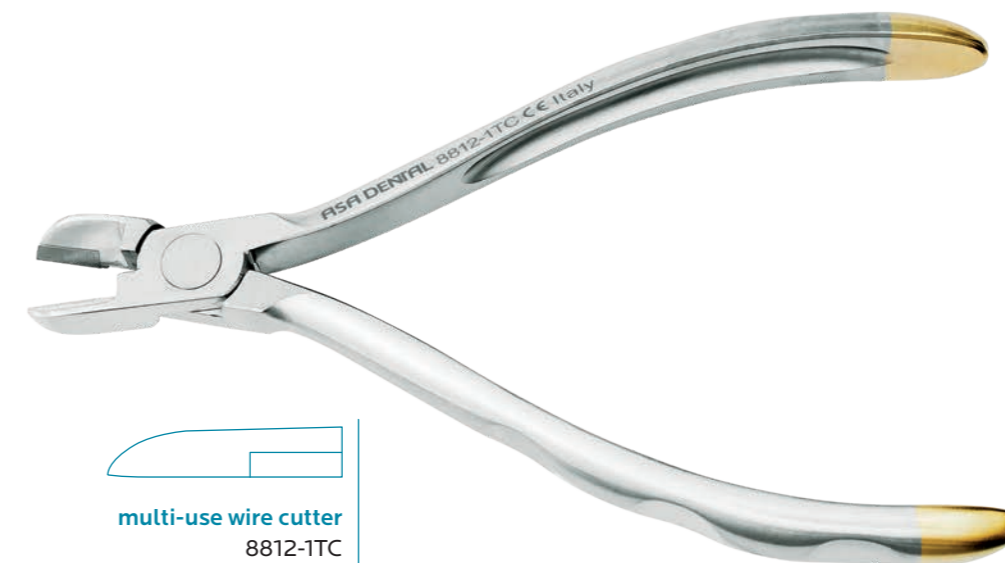

multi-use wire cutter
8812-1TC

Versatile hard wire cutter.
Wire size: max. 0.56 mm x 0.70 mm
(0.022" x 0.028")



multi-use wire cutter
5832



multi-use wire cutter
5832-1TC

Same as 5832 with tungsten carbide inserts

Cutters



micro-miniature wire cutter
5833

Ultra slim profile soft wire cutter for ligature wires.
Designed to enhance access in difficult areas.
Wire size: max. 0.30 mm (0.012")



micro-miniature wire cutter
5833-1TC

Same as 5833 with tungsten carbide inserts



wire cutter <= 0.9 mm
5880-1

Designed to cut wire pins and ligature wires,
it is strong enough to bend archwire ends after distal cutting.
Wire size: max. 0.9 mm (0.036")



wire cutter <= 1.5 mm
5880-2

Designed to cut wire pins and ligature wires,
it is strong enough to bend archwire ends after distal cutting.
Wire size: max. 1.5 mm (0.044")

Cutters



wire cutter <= 1.2 mm
5880-3TC

Designed to cut wire pins and ligature wires,
it is strong enough to bend archwire ends after distal cutting.
Wire size: max. 1.2 mm (0.044").
With tungsten carbide inserts



distal end cutter
5836

Distal end cutter with safety hold designed to cut hard wires
and hold the loose distal end, preventing damages
to patient oral tissue.
Wire size: rectangular max. 0.56 mm x 0.7 mm (0.022" x 0.028")
round max. 0.5 mm (0.020")



distal end cutter
5836-1TC

Same as 5836 with tungsten carbide inserts



micro distal end cutter
5837

Distal end cutter with safety hold designed to cut hard wires
and hold the loose distal end, preventing damages
to patient oral tissue.
Wire size: rectangular max. 0.56 mm x 0.7 mm (0.022" x 0.028")
round max. 0.5 mm (0.020")

Wire forming pliers



Delphin universal pliers
8801-1

Wire bending size: max. 0.90 mm (0.035")
Wire cutting size: max. 0.70 mm (0.028")



Delphin universal pliers
5801-1



universal pliers
8801-2

Wire bending size: max. 0.90 mm (0.035")
Wire cutting size: max. 0.70 mm (0.028")



universal pliers
5801-3

Wire forming pliers



Waldsachs pliers
8802

Wire bending size: max. 0.90 mm (0.035")
Wire cutting size: max. 0.70 mm (0.028")



Waldsachs pliers
5802



3 mm (0.118")
4 mm (0.157")
5 mm (0.197")
6 mm (0.236")

Nance precision pliers
8816

For precise forming of loop
in 4 different lengths: 3, 4, 5 and 6 mm.
Groove at base aids in closing loops.
Wire size: max. 0.70 mm (0.028")

Wire forming pliers



Nance pliers
5800

Nance loop closing pliers, for bending of stop loops and special pliers for Adams' clasps.
Wire size: max. 0.7 mm (0.028")



round-concave pliers
5806

Round-concave pliers for loop forming and bending of thin round and square.
Wire size: max. 0.5 mm (0.020")



Tweed loop pliers
5809-1

Loop forming pliers for round and rectangular wires, with replaceable cylindrical beak. The concave beak with parallel serrations firmly holds the wire in position.
Wire size: max. 0.56 x 0.7 mm (0.022" x 0.028")
Beak size: 1.15 mm (0.045"), 1.50 mm (0.059"), 1.90 mm (0.075")

Wire forming pliers

1.20 mm (0.047")
1.60 mm (0.063")
2.00 mm (0.075")

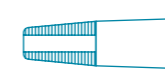

Omega Tweed loop pliers
8804-2

Loop forming pliers for round and rectangular wires, with replaceable cylindrical beak. The concave beak with parallel serrations firmly holds the wire in position.
Wire size: max. 0.70 mm (0.028")



8804-2P
replacement tip for pliers 8804-2



8804-3P
replacement screw and L-key
for pliers 8804-2



Omega Tweed loop pliers
5809-2

Wire forming pliers

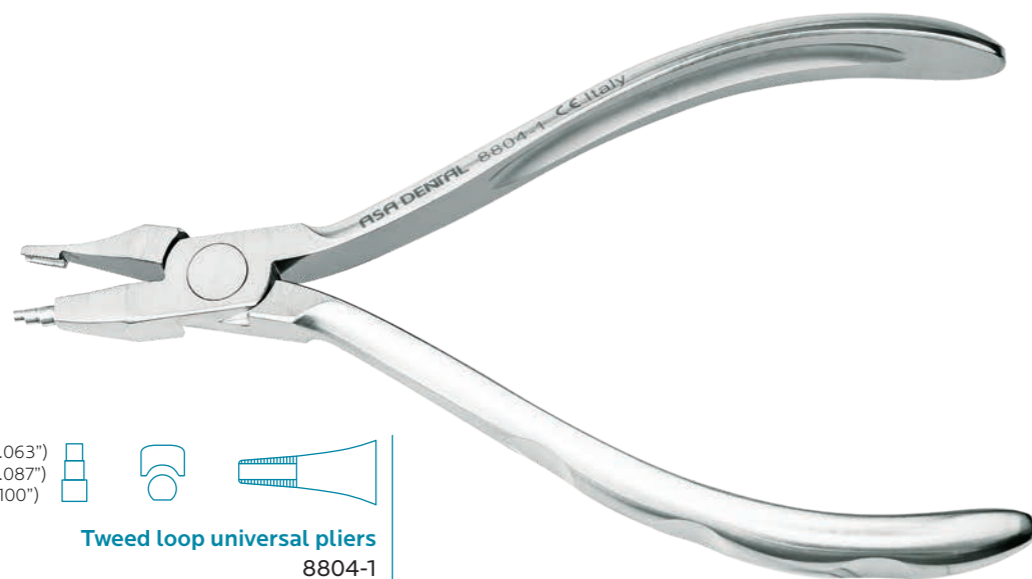

- 1.60 mm (0.063")
- 2.20 mm (0.087")
- 2.80 mm (1.100")

Tweed loop universal pliers
8804-1

Loop forming pliers for creating bull and helical loops with different diameters.
Wire size: max. 0.70 mm (0.028")



Tweed loop universal pliers
5870

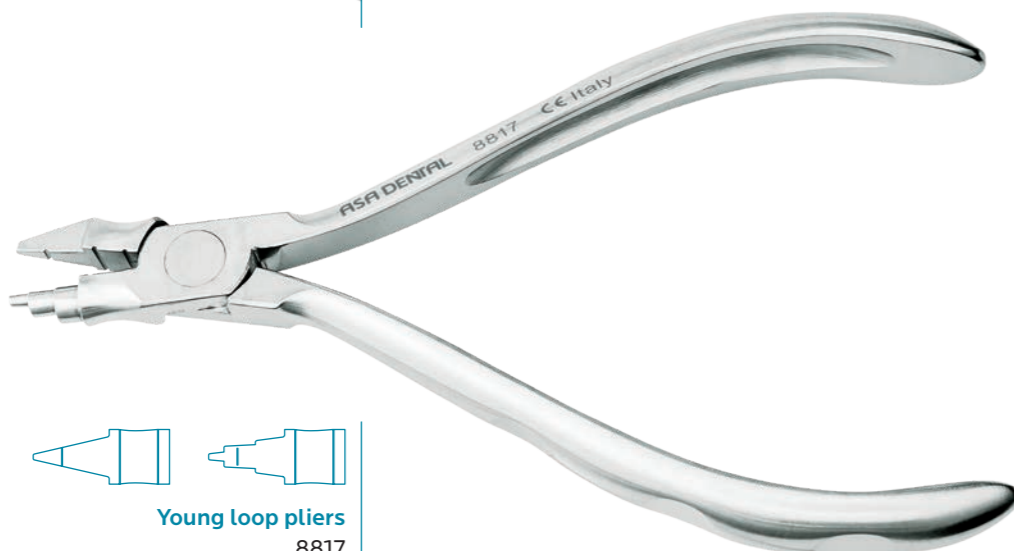

- 3 mm (0.118")
- 4 mm (0.157")
- 5 mm (0.197")
- 6 mm (0.236")

Young loop pliers
8817

Loop forming pliers for different lengths and ideal for labial arches.
Wire size: max 0.70 mm (0.028")

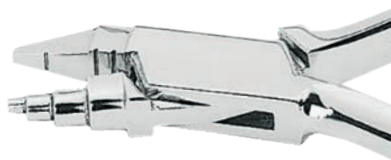

Young pliers
5863

Wire forming pliers



Tweed loop pliers
5809-3

Single diameter loop forming pliers with one replaceable beak and a concave serrated one.
Wire size: max. 0.56 x 0.7 mm (0.022" x 0.28")
Beak size: 1.50 mm (0.059")



Tweed (Angle) pliers
5872-1

Tweed (Angle) arch bending pliers - short - Pliers with beaks (10 mm) designed for convenient handling of square or rectangular wires the blades are parallel at 0.5 mm (0.020") pliers' opening



Nance loop pliers
5862

Designed for precise forming of loops in 4 different lengths, for round and rectangular wires.
Wire size: max. 0.7 mm (0.028")

Wire forming pliers



Reynolds pliers
8805

Contouring pliers for archwires



Reynolds pliers
5812

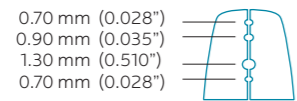

lingual arch pliers
8807-3

0.76 mm - 0.90 mm (0.030" - 0.036")
Wire size: max. 0.90 mm (0.036")



lingual arch pliers
5818

Wire forming pliers

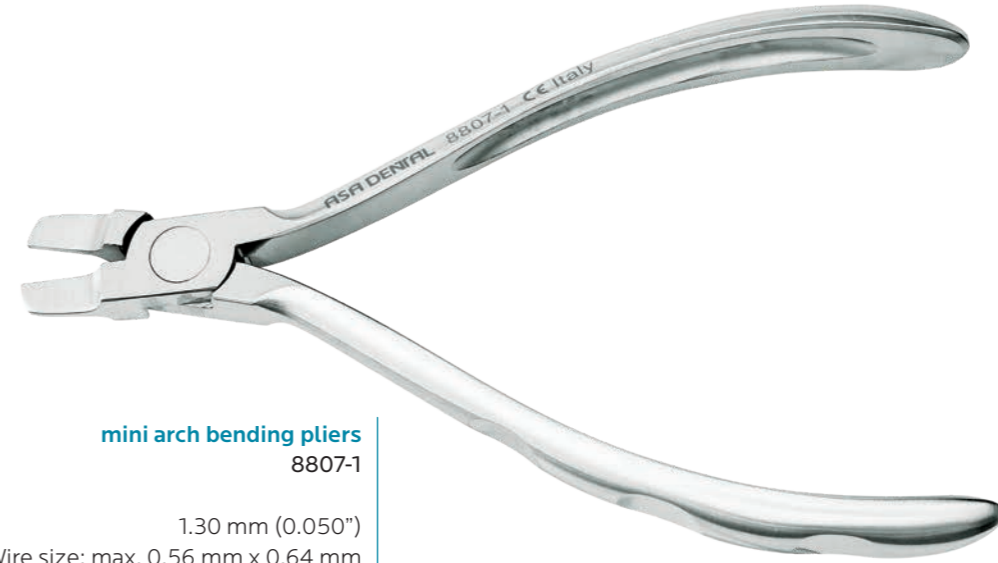

mini arch bending pliers
8807-1

1.30 mm (0.050")
Wire size: max. 0.56 mm x 0.64 mm
(0.022" x 0.025")



arch bending pliers
8807-2

1.78 mm (0.067")
Wire size: max. 0.56 mm x 0.64 mm
(0.022" x 0.025")

Wire forming pliers

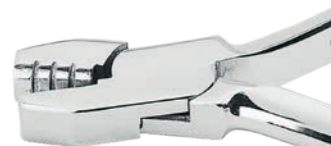

De La Rosa grooved pliers
5821-1

Arch forming pliers. Designed to form and contour arch wires on round or rectangular wire. The beak has grooves of 0.4 mm (0.016"), 0.46 mm (0.018") and 0.56 mm (0.022")



De La Rosa non-grooved pliers
5821-2

Arch forming pliers with a non-grooved contouring surface for the forming of precise arches



Mc Kellops pliers
5860-1

Round and concave heavy wire pliers. For forming loops in hard clasp wires or labial arch wires. Wire size: max. 0.8 mm (0.032")



flat bending pliers
5864

Wire bending pliers, for wires. Wire size: max. 0.9 mm (0.036")

Wire forming pliers



short rounded jaws pliers
5865

Double rounded jaw wire bending pliers, for wires. Wire size: max. 0.7 mm (0.028")



long rounded jaws pliers
5868

Double rounded jaw wire bending pliers, for wires. Wire size: max. 0,7 mm (0.028")



Angle pliers
5866

Bird Beak Angle pliers for bending round, square or rectangular wire. Wire size: max. 0.7 mm (0.028")



Angle pliers with cutter
5838

Bird beak pliers for bending round, square or rectangular wire. With cutter. Wire size: max. 0,7 mm (0.028")

Wire forming pliers



Adams pliers
8819

Designed for precise angle bends at 90°



Adams pliers
12.2 cm
5867-1

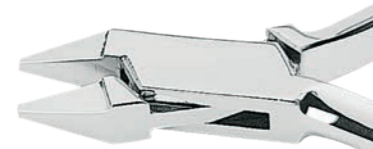

Adams pliers
14.2 cm
5867-2

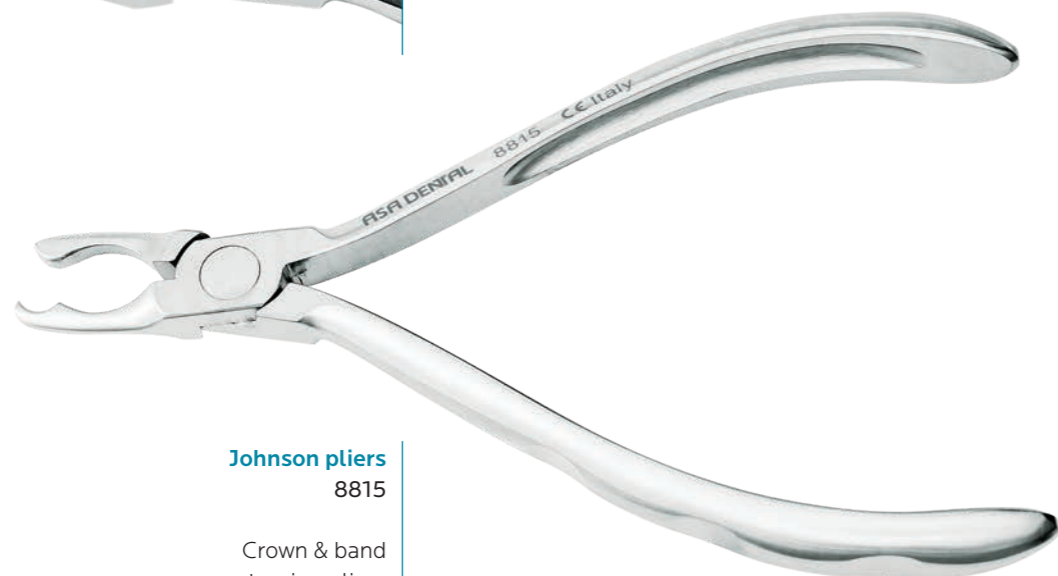

Johnson pliers
8815

Crown & band contouring pliers



Johnson pliers
5861

Wire forming pliers



Aderer mini pliers
8820-1

Three-jaw bending pliers.
Wire size: max. 0.50 mm (0.020")



Aderer mini pliers
5869-1



Aderer standard pliers
8820-2

Three-jaw bending pliers.
Wire size: max. 0.70 mm (0.028")



Aderer standard pliers
5869-2

Wire forming pliers

□
○

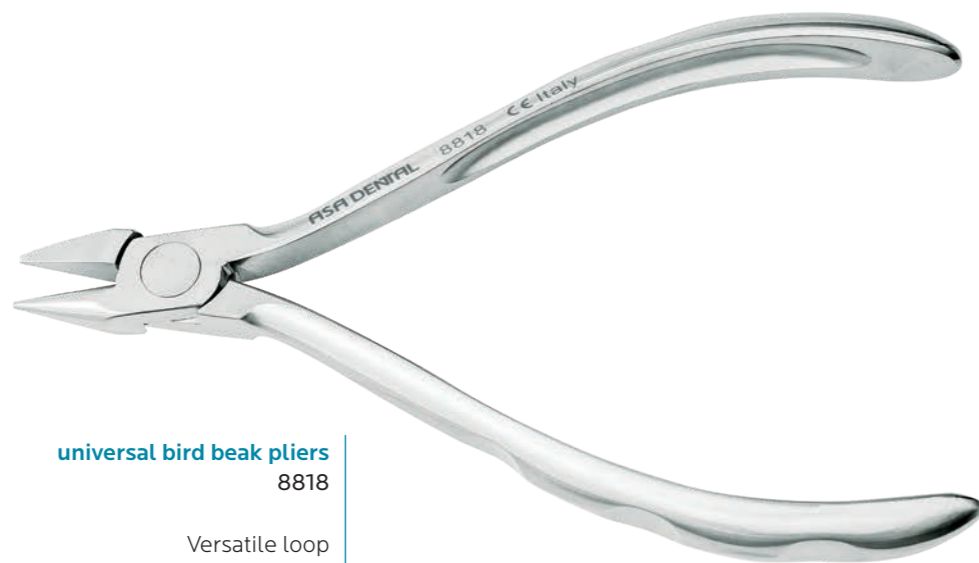

universal bird beak pliers
8818

Versatile loop forming pliers for wires

□
○



bird beak pliers
8821

Light wire pliers with groove with a longer cone that facilitates forming precise loops. The groove allows locating and duplicating loops. Wire size: max. 0.70 mm (0.028")

Wire forming pliers



How universal pliers
8822-1

Straight. Utility pliers with cross-serrated tips. Perfect to position and remove orthodontic arches and pins



How universal pliers
5874-1

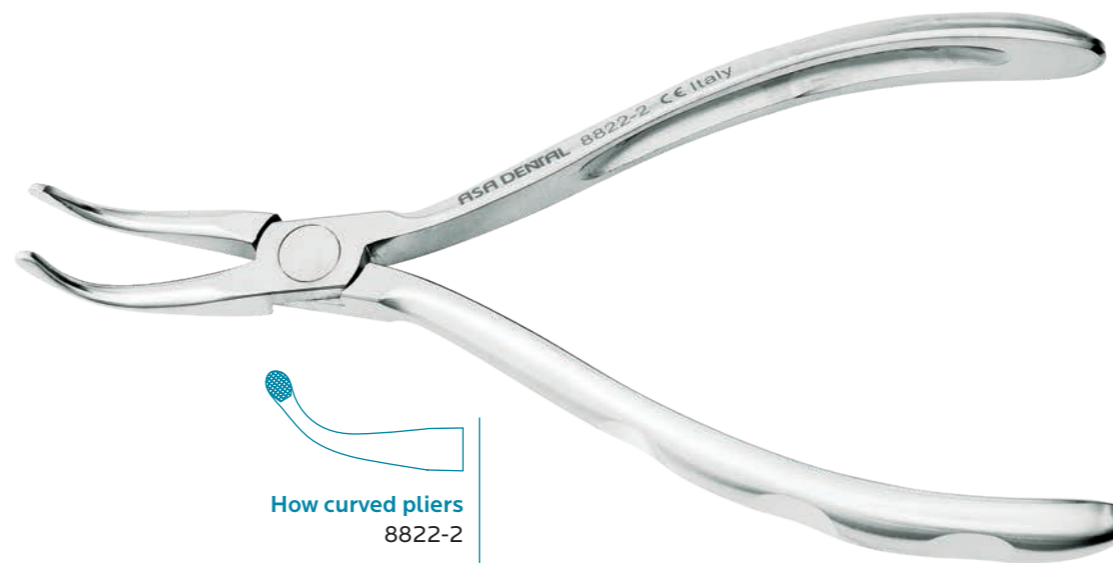

How curved pliers
8822-2

Angled. Utility pliers with cross-serrated tips angled at 40° to easily reach areas of difficult access



How curved pliers
5874-2

Wire forming pliers

△
○



light bird beak pliers
5871

Designed for bending round, square or rectangular wires.
Wire size: max. 0.4 mm (0.016")



flat bending pliers
5875-1

Flat nose pliers with smooth beaks for bending wires.
Wire size: max. 0.7 mm (0.028")



flat knurled bending pliers
5875-2

Bending wires.
Wire size: max. 0.7 mm (0.028")



knurled bending pliers
5876-1

Wire size: max. 0.7 mm (0.028")



bending pliers
5876-2

Wire size: max. 0.7 mm (0.028")

Wire forming pliers



Schwarz pliers
8823

Arrow clasp forming pliers.
Wire size: max. 0.70 mm (0.028")

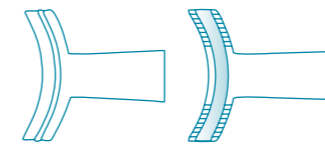

hammerhead NiTi pliers
8825

Multi purpose pliers for easy wire bending and loop forming, without the use of heat

Wire forming pliers

optical pliers
8803

Pliers with groove,
excellent for forming helical
closing loops and wire bending
of round and rectangular wires.
Wire size: max. 0.70 mm (0.028")

Wire forming pliers

Jarabak pliers
8829

Multipurpose light wire bending pliers.
Grooves allow precise bending
and closing of loops.
Wire size: max. 0.70 mm (0.028")

hollow chop pliers
8806

Contouring pliers (De La Rosa).
Ideal for arch contouring.
Wire size: max. 0.70 mm (0.028")

V-stop pliers
8830

Designed to place V-bend in arch wires,
including nickel titanium and
prevent archwire from travelling.
Wire size: max. 0.70 mm (0.028")

Wire forming pliers



Nance precision pliers
8816



universal Tweed pliers
8804-1

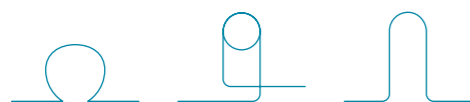

Tweed omega pliers
8804-2



lingual arch pliers
8807-3



Adams pliers
8819



hammerhead NiTi pliers
8825



V-stop pliers
8830



mini arch bending pliers
8807-1
arch bending pliers
8807-2



Aderer mini pliers
8820-1
Aderer standard pliers
8820-2



universal bird beak pliers
8818
bird beak pliers
8821

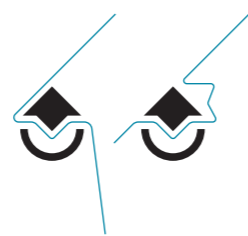

Schwarz pliers
8823

Utility pliers



Weingart pliers
8808-1

Utility pliers with cross-serrated tips, ideal for ligatures

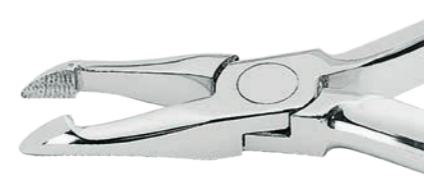

Weingart pliers
5819

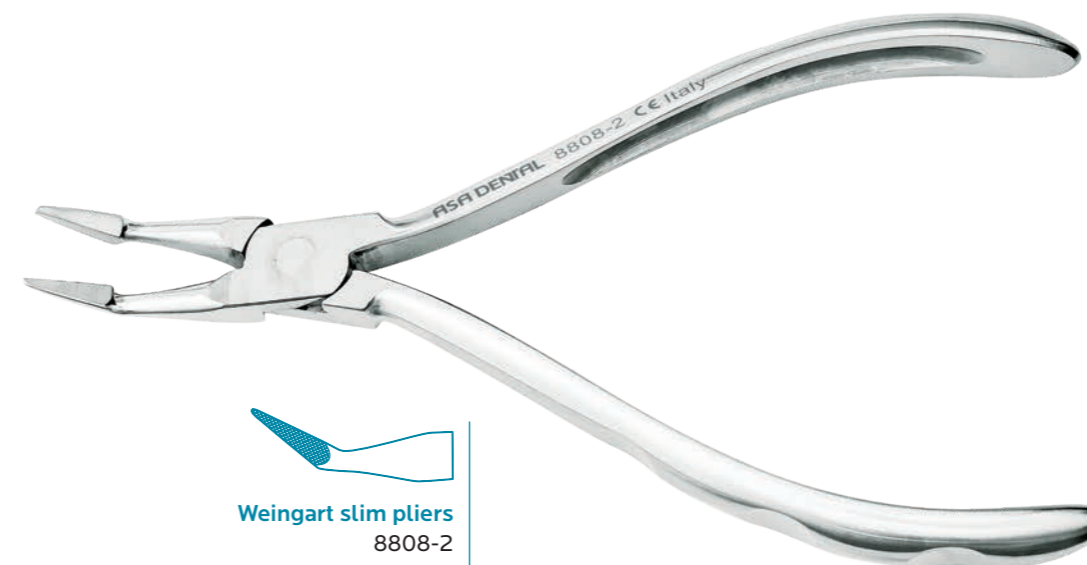

Weingart slim pliers
8808-2

Slim utility pliers with cross-serrated tips, ideal for ligatures

Utility pliers



wide beak removing pliers
5826-1

Direct bonding bracket remover with "Wide beak" pad. Designed for quick, comfortable removal of direct bonded brackets and elimination of adhesive residues. Wide tip.

T

4.4 mm (1/4")
5826-CR1
replacement pads
for 5826-1-2, 5828-1-2

T

4.8 mm (3/16")
5826-CR2
replacement pads
for 5826-1-2, 5828-1-2



narrow beak removing pliers
5826-2

Direct bonding bracket remover with "Narrow beak" pad. Similar to 5826-1



short posterior band remover
8811-1

Posterior band and bracket removing pliers, short. The tip is aligned below the lower end of the occlusal pad.



8811-1P
replacement for
8811-1 and 8811-2



short posterior band remover
5828-1

Utility pliers



long posterior band remover
8811-2

Long posterior band and bracket removing pliers, long. The tip is centered on the occlusal pad



8811-1P
replacement for
8811-1 and 8811-2



long posterior band remover
5828-2



wide bracket removing pliers
8809

Bracket-removing pliers, straight. Ideal for all types of steel, plastic and ceramic brackets



wide bracket removing pliers
5824-1

Utility pliers



angled bracket removing pliers
8810

Bracket-removing pliers, angled.
Ideal for all types of steel,
plastic and ceramic brackets



angled bracket removing pliers
5825



adhesive removing pliers
8831

Adhesive-removing pliers
with reversible and
replaceable blade



8831-1P
replacement for 8831

Utility pliers



universal band slitter
8828-1TC

Band slitter.
Wire size: max. 0.40 mm (0.015")

8828-1TC

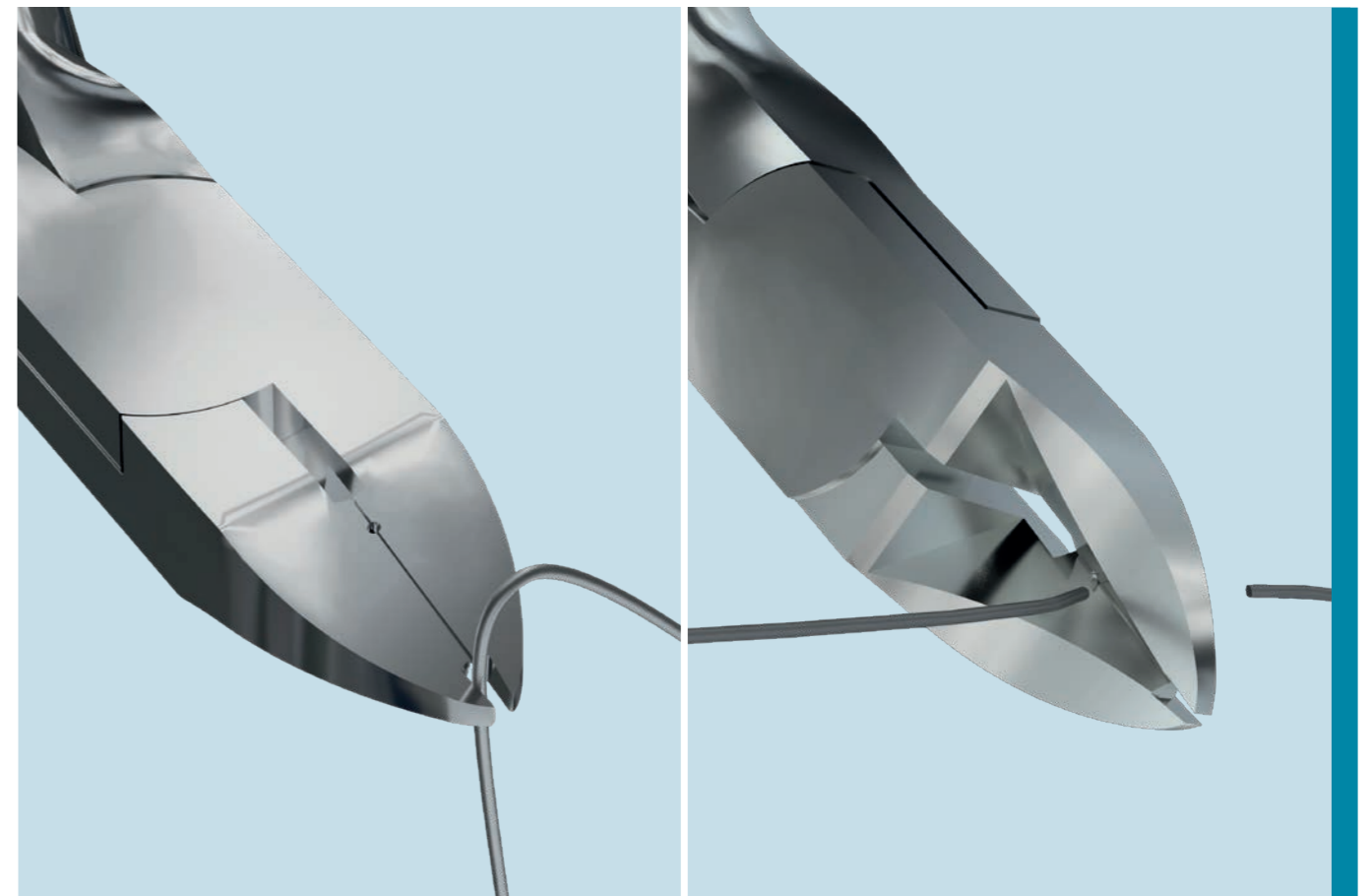

Hand instruments

direct bond bracket holders
self-holding with reverse action
will not release the bracket until pressed



13.5 cm
2400

13.5 cm
2402

13.5 cm
2401

band pusher



Mershon
14 cm
2410

band setter
with tin insert



15 cm
2411

band pusher
used in all heat
sterilizers



13.5 cm
2412

Hand instruments

ligature instruments

band seating and
removing instruments



1351-1

1350-1

1350-2

elastic
instrument



1352-1

separating pliers for
elastics and separators



15.5 cm
2450

Hand instruments

bracket placement marker
measuring gauge 3.5 / 4.0 / 4.5 / 5.0 mm



8832

elastic forceps

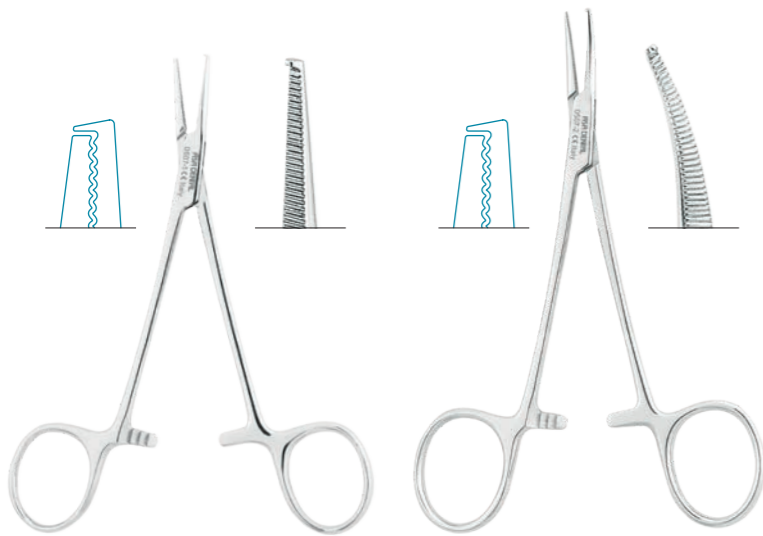

1 Halstead-Mosquito
straight
12 cm
0507-1

2 Halstead-Mosquito
curved
12 cm
0507-2

ligature and archwire tucker

2 mm

3 mm



Luniatschek
1355-1

Luniatschek
1355-2

Ortho/prothesis boxes

plastic box for removable retainers
10 pcs / pack



Blue
6900E-A



White
6900E-B



Light blue
6900E-C



Yellow
6900E-G



Pink
6900E-R



Green
6900E-V



INSTRUMENT CASSETTES AND TRAYS

MADE IN ITALY

OPERATIONAL EFFICIENCY MADE EASY

The more your dental studio grows the more effective your procedures need to be. Efficiency becomes a direct consequence of an organized practice with proper instruments handling to reduce waste of time and increase patient's safety. Asa Dental manufactures trays, cassettes and boxes to conveniently transport, sterilize and store those instruments that make your daily practice crucial to improve the quality of life of your patients, whether they need to solve aesthetic or functional problems.

A wide range of accessories complements cassettes and trays to effectively allocate space and prevent damages to delicate parts and coatings during reprocessing steps. Finally, they come in a wide range of size, shapes and materials to meet all the needs of a structured dental studio.

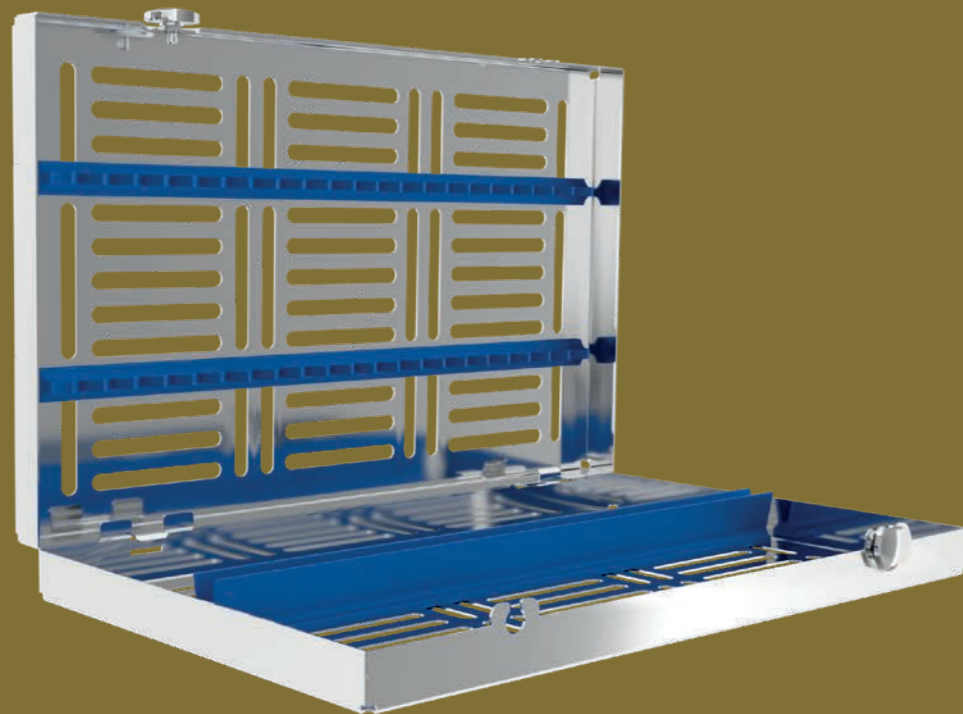

- I2 Steel cassettes
- I4 Steel trays
- I8 Aluminum trays and accessories
- I12 Autoclave instrument protection lubricant
- I13 Aluminum containers
- I13 Aluminum racks
- I13 Sterilizing forceps
- I14 Endodontic boxes
- I17 Bur holders
- I18 Accessories

Stainless steel instrument cassettes

LARGE
288x182x34 mm

complete with silicone insert frame
for 20 instruments

- Blue
2770-1
- Orange
2770-1A
- Red
2770-1R
- Green
2770-1V



complete with silicone insert frame
for 15 instruments

- Blue
2770-2
- Orange
2770-2A
- Red
2770-2R
- Green
2770-2V



complete with silicone insert frame
for 10 instruments

- Blue
2770-3
- Orange
2770-3A
- Red
2770-3R
- Green
2770-3V



288x182x60 mm

- Orange
2780-1A



MEDIUM
182x144x34 mm

complete with silicone insert frame
for 10 instruments

- Blue
2771-1
- Orange
2771-1A
- Red
2771-1R
- Green
2771-1V



complete with silicone insert frame
for 5 instruments

- Blue
2771-2
- Orange
2771-2A
- Red
2771-2R
- Green
2771-2V



Stainless steel instrument cassettes

MINI
182x72x34 mm

complete with silicone insert frame
for 5 instruments

- Blue
2772-1
- Orange
2772-1A
- Red
2772-1R
- Green
2772-1V

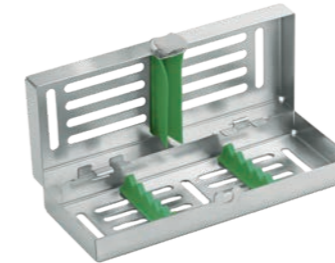

silicone instrument holder
for 10 places

- Blue
2770-G
- Orange
2770-GA
- Red
2770-GR
- Green
2770-GV



silicone instrument holder
for 5 places

- Blue
2771-G
- Orange
2771-GA
- Red
2771-GR
- Green
2771-GV



silicone insert frame
for 10 places

- Blue
2772-G
- Orange
2772-GA
- Red
2772-GR
- Green
2772-GV



silicone insert frame
for 5 places

- Blue
2773-G
- Orange
2773-GA
- Red
2773-GR
- Green
2773-GV



set of 2 spare stainless steel
knobs complete of washers



2774

#2 clips for locking trays
for scissors

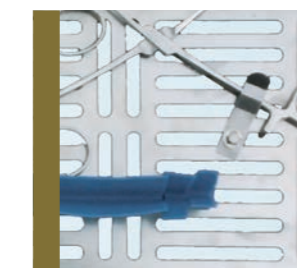

2775

Stainless steel instrument trays

LARGE
288x187x39 mm

instrument tray complete with perforated base, perforated lid and insert frame

for 16 instruments
S2722-1

perforated instrument tray complete with insert frame

for 23 instruments
S2722-2

288x187x29 mm
perforated lid
2721-U

284x183x17 mm
perforated base
2721-L



Stainless steel instrument trays

LARGE
288x187x39 mm

instrument tray complete with non-perforated base, non-perforated lid and insert frame

for 16 instruments
S2720-1

non-perforated instrument tray complete with insert frame

for 23 instruments
S2720-2

288x187x29 mm
non-perforated lid
2720-U

284x183x17 mm
non-perforated base
2720-L



instrument tray complete with perforated base, non-perforated lid and insert frame

for 16 instruments
S2721-1

instrument tray complete with perforated base, non-perforated lid and insert frame

for 23 instruments
S2721-2

288x187x29 mm
non-perforated lid
2720-U

284 x 183 x 17 mm
perforated base
2721-L



stainless steel insert frame
for 16 instruments
2730-1

stainless steel insert frame
for 23 instruments
2730-2

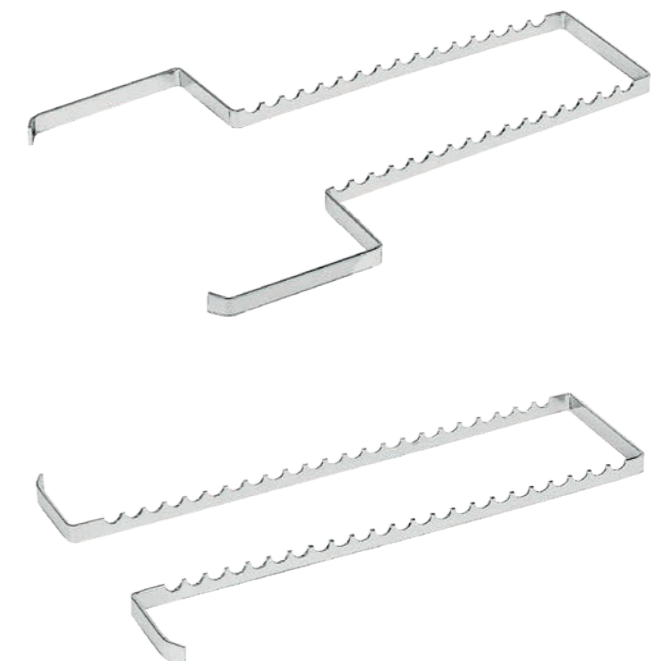

Stainless steel instrument trays

MEDIUM
200x100x30 mm

instrument tray complete with
perforated base, perforated lid
and insert frame

for 7 instruments
S2702

200x100x10 mm
perforated lid
2702-U

200x100x30 mm
perforated base
2702-L

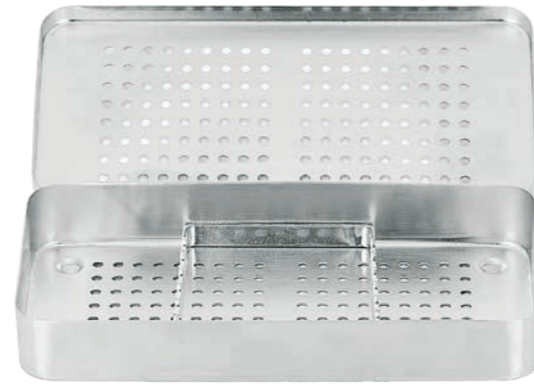

instrument tray complete with
non-perforated base, non-perforated lid
and insert frame

for 7 instruments
S2700

200x100x10 mm
non-perforated lid
2700-U

200x100x30 mm
non-perforated base
2700-L

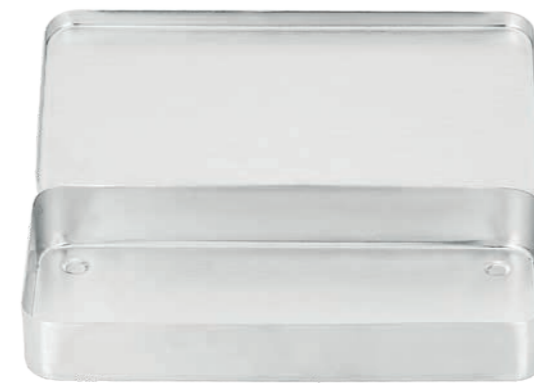

stainless steel insert frame
for 7 instruments
2700-G



Stainless steel instrument trays

MEDIUM
187x144x39 mm

instrument tray complete with
perforated base, perforated lid
and insert frame

for 8 instruments
S2723-1

instrument tray complete with
perforated base, perforated lid
and insert frame

for 4 instruments
S2723-2

187x144x29 mm
perforated lid
2723-U

183x142x17 mm
perforated base
2723-L



instrument tray complete with
non-perforated base, non-perforated lid
and insert frame

for 8 instruments
S2724-1

instrument tray complete with
non-perforated base, lid and insert frame

for 4 instruments
S2724-2

187x144x29 mm
non-perforated lid
2724-U

183x142x17 mm
non-perforated base
2724-L



stainless steel insert frame
for 8 instruments
2730-4

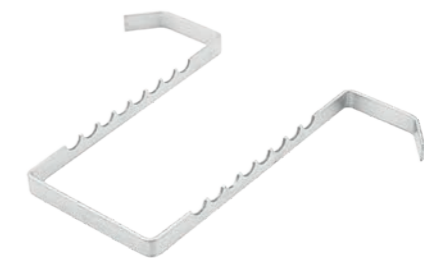

stainless steel insert frame
for 4 instruments
2730-5

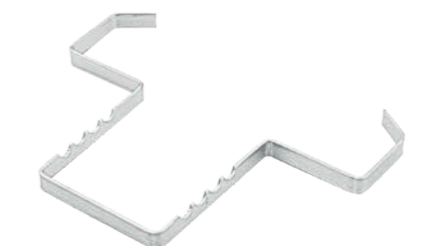

Aluminum colour-coded instrument trays

LARGE
284x183x17 mm

Light blue
AL2720-LC

Red
AL2720-LR

Gold
AL2720-LO

Green
AL2720-LV

Silver
AL2720-LA

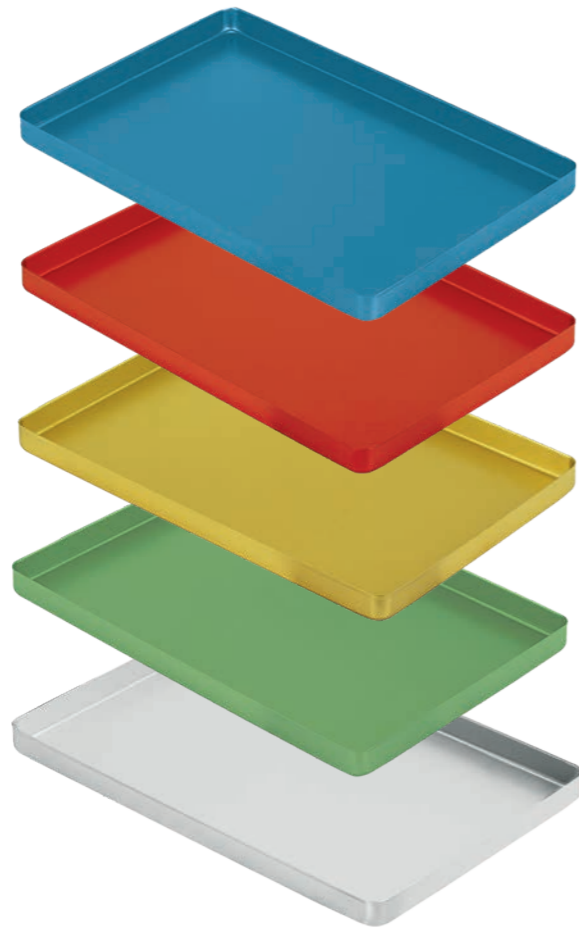

288x187x29 mm
lid

Silver
AL2720-UA



Aluminum insert frames

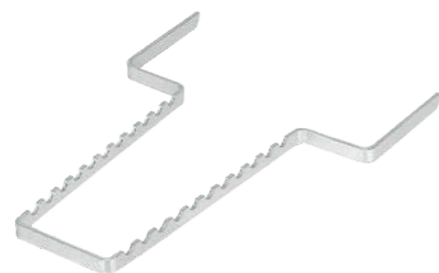

for 11 instruments
AL2730-1

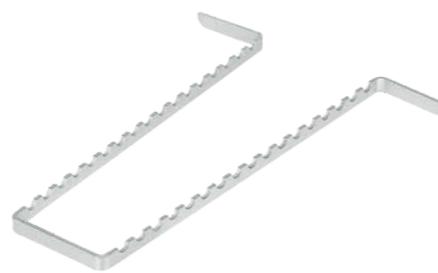

for 17 instruments
AL2730-2

Aluminum colour-coded instrument trays - perforated

LARGE
284x183x17 mm

Light blue
AL2721-LC

Red
AL2721-LR

Gold
AL2721-LO

Green
AL2721-LV

Silver
AL2721-LA

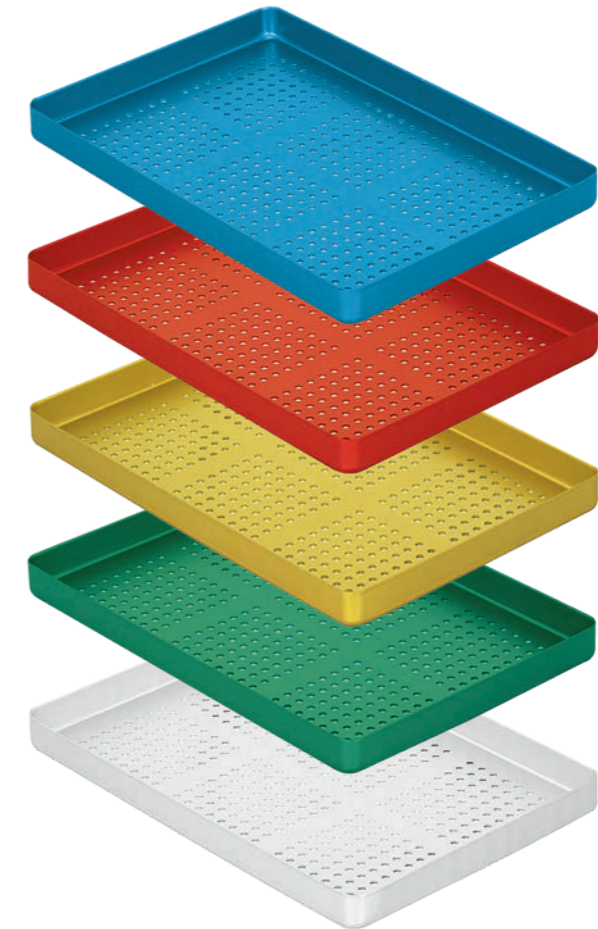

288x187x29 mm
lid

Silver
AL2721-UA

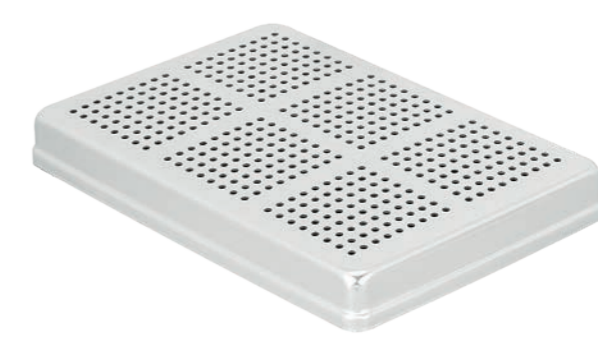

Aluminum insert frames



for 10 instruments
AL2730-3

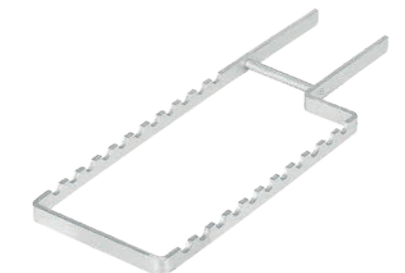

for 11 instruments
AL2730-4

Aluminum colour-coded instrument trays

MEDIUM
142x183x17 mm

Light blue
AL2722-LC

Red
AL2722-LR

Gold
AL2722-LO

Green
AL2722-LV

Silver
AL2722-LA

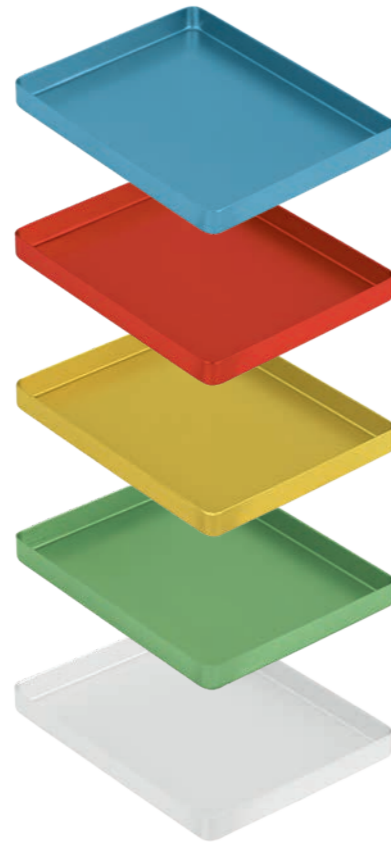

144x187x29 mm
lid

Silver
AL2722-UA



Aluminum colour-coded instrument trays

MINI
100x180x11 mm

Light blue
AL2723-LC

Red
AL2723-LR

Gold
AL2723-LO

Green
AL2723-LV

Silver
AL2723-LA



103x182x10 mm
lid

Silver
AL2723-UA



AL2722-LC
aluminum instrument trays
for operating procedures

Aluminum insert frames

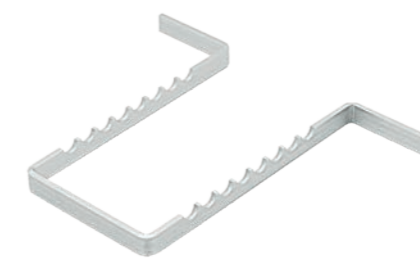

for 8 instruments
AL2731-1

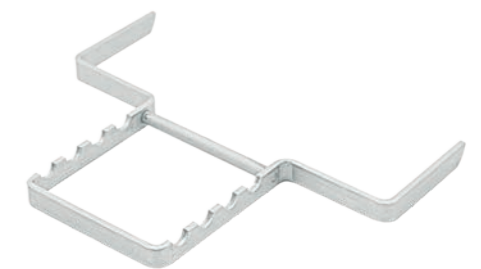

for 4 instruments
AL2731-2

Stainless steel trays

MAXI
200x150 mm



2737-1



2737-2

kidney trays



2737-3
170x100x35 mm



2737-4
250x140x40 mm

Pliers tray

stainless steel pliers tray
STANDARD



S5800

Autoclave instrument protection lubricant

Best instruments' autoclaving protection. Penetrates and lubricates all instruments' joints. Protects all dental and surgical hand instruments before and after sterilization. Instructions for use: oil all tips, joints and fastening of instruments before and after sterilization



Steril Oil
40 ml
8002

Specific lubricant for dental and surgical instruments. The lubricant is designed to lubricate joints of all dental instruments (scissors, haemostatic and extracting forceps, bone rongeurs, needle holders etc.). Before and after sterilization it does not dry out during sterilization. Provides protection from corrosion and other deposits and ensures proper operation of the instruments



Silicone
40 ml
8010

Aluminum containers for instrument trays



AL2724-1
49x26x10 mm



AL2724-2
49x26x10 mm



AL2724-3
59x49x10 mm



AL2724-4
59x49x10 mm

Aluminum instrument tray rack

STANDARD
300x190x270 mm

MEDIUM
160x190x270 mm



6 compartments
AL2739-1



6 compartments
AL2739-2

Sterilizing forceps



20 cm
0565-1



30 cm
0565-2

Endodontic boxes

aluminum endodontic boxes complete with lid

MAXI
204x105x54 mm



AL2740-1



AL2740-2



AL2740-3

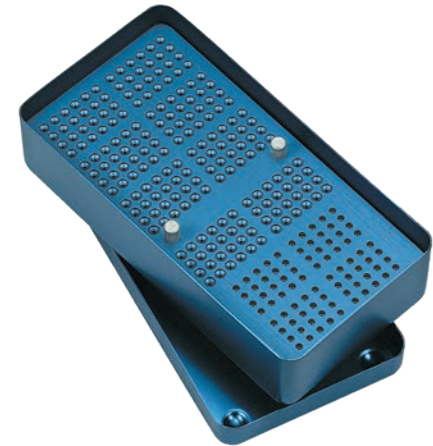

AL2740-4

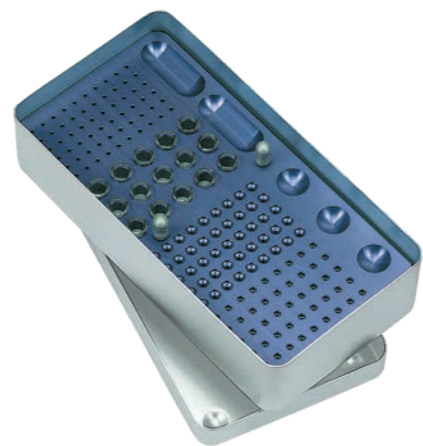

AL2740-5

MEDIUM
125x105x54 mm



AL2741-1



AL2741-2

spare glasses for endo-box



AL2740-R

Endodontic boxes

aluminum endodontic boxes complete with lid

MINI
100x44x54 mm



AL2742-1



AL2742-2

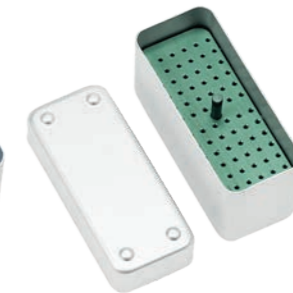

AL2742-3



AL2742-4



AL2742-5



AL2742-6



AL2742-7

round aluminum endodontic boxes
complete with lid



AL2744
Ø 48 mm - h. 62 mm



AL2743
Ø 94 mm - h. 70 mm

spare glasses for endo-box



AL2740-R

Endodontic articles

aluminum endodontic tray complete with lid
257x116x16 mm

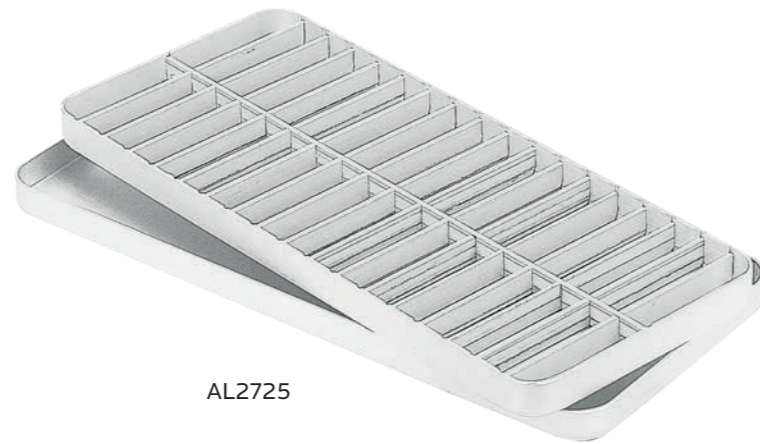

AL2725

aluminum endodontic instrument cleaners
Ø 40 mm - h. 30 mm



AL2746-1



AL2746-2

aluminum endometers
100x40x40 mm



AL2747-1A

aluminum endometers
Ø 34 mm - h. 48 mm



AL2745-1A



AL2745-2C

Bur holders



with 7 bur holders
with lid
AL2763-1



with 2 bur holders
AL2763-2

autoclavable
atoxic food colored silicon
the plastic cover is not autoclavable

- possibility to insert both turbines' and micromotors' burs, permitting to prepare a unique bur holder which contains all the necessary burs
- possibility to prearrange operative sets by color distinguished (on the market you can find bur holders with not less than 6 different colors), permitting to organize at most warehousing and timing of intervention and choice
- prevention by burs accidental falls due to upsetting of the bur holder, which means prevention by possibility of breaking or sterilize one more time burs, thanks to cross holes that you can find on the best silicon bur holders. AsaFresh is patented by Asa Dental



Orange
S2760-A



Blue
S2760-C

aluminum
suitable for steam sterilizing



with rim, 24 holes FG
AL2760-1
(small burs)



with rim, 24 holes CA
AL2760-2
(big burs)



with rim, 24 holes FG/CA
AL2760-3
(small big burs)



AL2760-U
lid



with rim, 36 holes FG
AL2761-1
(small burs)



with rim, 36 holes CA
AL2761-2
(big burs)



with rim, 36 holes FG/CA
AL2761-3
(small big burs)



AL2761-U
lid for AL2761-1, 2, 3
and for silicon bur holder



48 holes FG
AL2762-1
(small burs)



48 holes CA
AL2762-2
(big burs)



48 holes FG/CA
AL2762-3
(small big burs)

Accessories

aluminum waste container
sterilizable
available in 5 colours
Ø 7 x h. 7.5 cm



AL2764-A



AL2764-C



AL2764-O



AL2764-R



AL2764-V

aluminum cotton dispensers with internal spring
sterilizable
available in 5 colours
Ø 7 x h. 7.5 cm



AL2765-A



AL2765-C



AL2765-O



AL2765-R



AL2765-V

disposable waste containers
1000 pcs / box



AL2767-1

aluminum base
for waste containers



AL2767-2

Accessories

plastic box for used needles



AL2766

stainless steel cotton pellet dispenser
40x40x50 mm



2751-1

stainless steel
alcohol burner



3101



spare wick
15 cm



3101-1

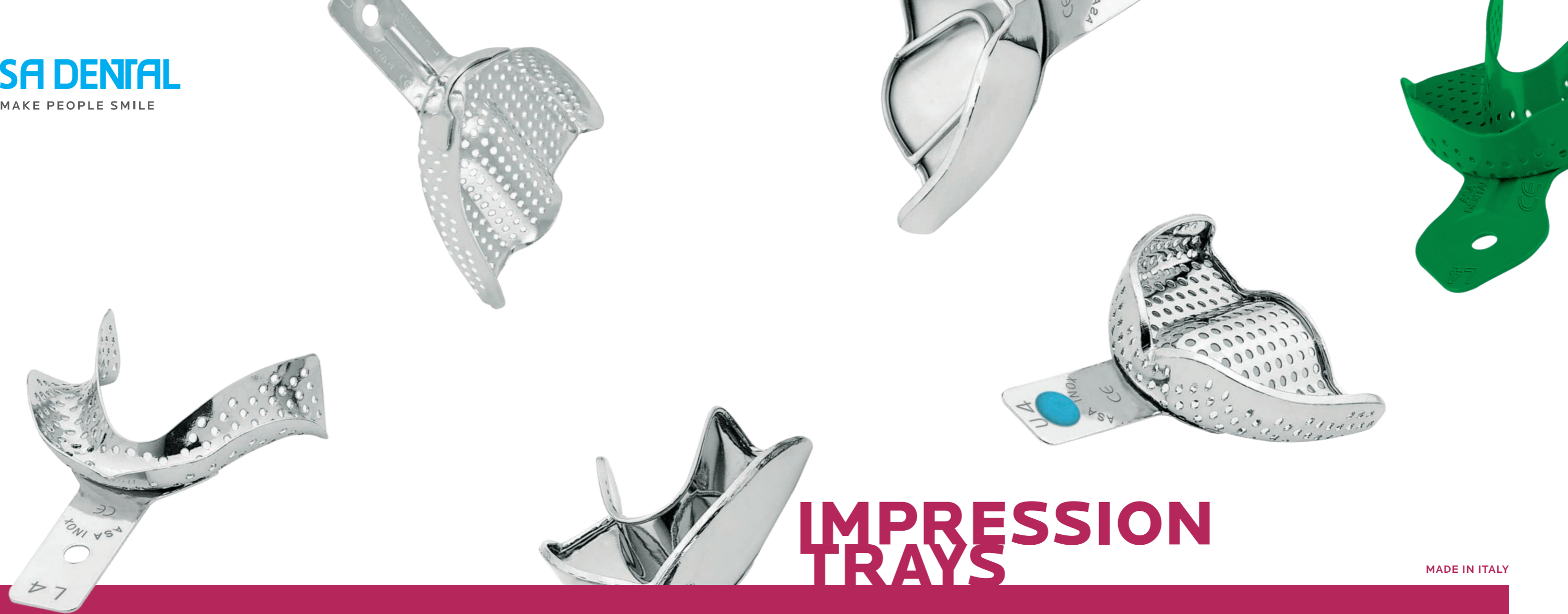

IMPRESSION TRAYS

MADE IN ITALY

FIRST IMPRESSION

Many professionals consider impression trays simply as carriers for impression material rather than an important component in the treatment program. Therefore, they under estimate the importance of a correct choice in terms of size, shape, material and dimensional accuracy. Choosing the wrong size or the incorrect shape usually lead to inadequate impression taking: restorations and prosthesis can prove to be ill-fitting, asking for additional time of your work and more costs for your patient. Asa Dental impression trays come in different shapes and materials, with a convenient colour indexing for easy size selection, and all the necessary dimensional accuracy that proves them a key factor for the perfect outcome.

- J4 Perforated, steel
- J20 Non-perforated, steel
- J36 Perforated, aluminum
- J39 For children, aluminum
- J40 Partial occlusal
- J41 For implantology, aluminum
- J42 Polycarbonate

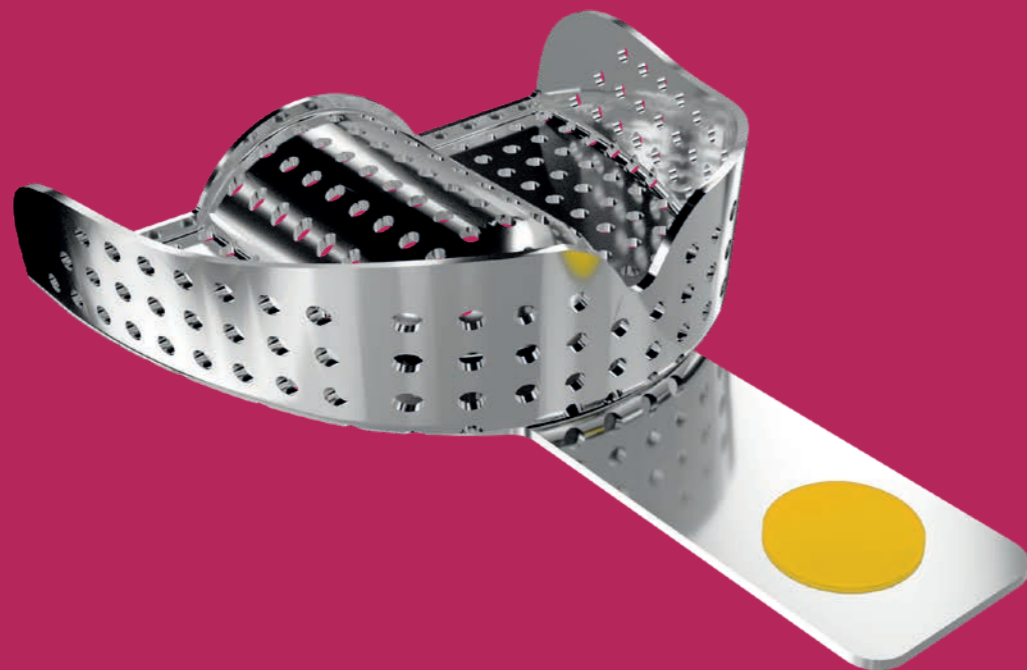

Impression trays parts

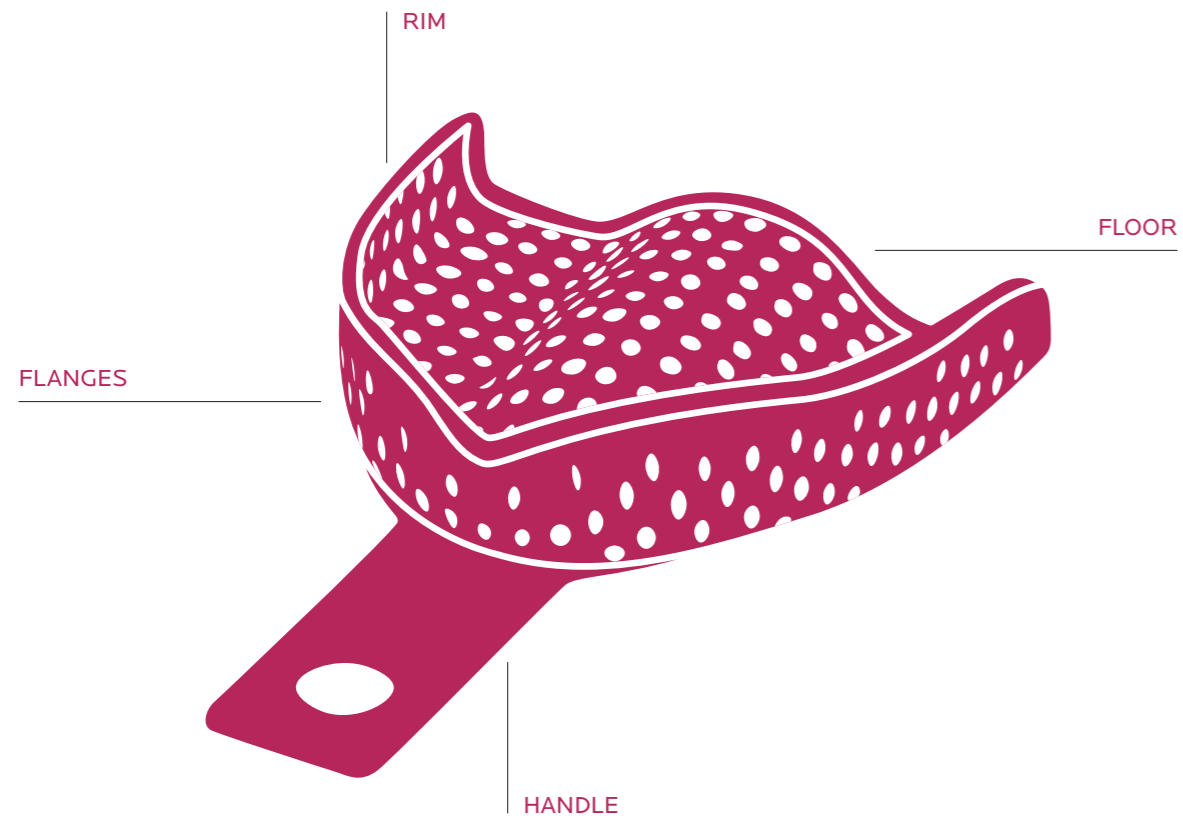

Trays selector

IMPRESSION MATERIALS	IMPRESSION TECHNIQUE					
	Monophase 2 materials	Monophase 1 material	Two-phase	Border molding	Half arch	Sandwich
Silicone	2802 2803 2807	2880	2800 2801 2804 2804S 2808 2809 2811 2813 2814 2806		2819	2819 2803S
Alginate	2804S 2813	2851 2852 2804 2801 2800 2814	2806 2851	2851		
Polyether/Polysulfide	2802 2803 2807	2802 2803 2803S 2807 2810				2807S 2810

Legenda

2880: ideal
2807: compatible

Color index

ASA Codicolor

- U1/L1**
XXS
- U2/L2**
XS
- U3/L3**
S
- U4/L4**
M
- U5/L5**
L
- U6/L6**
XL



Types of impression trays

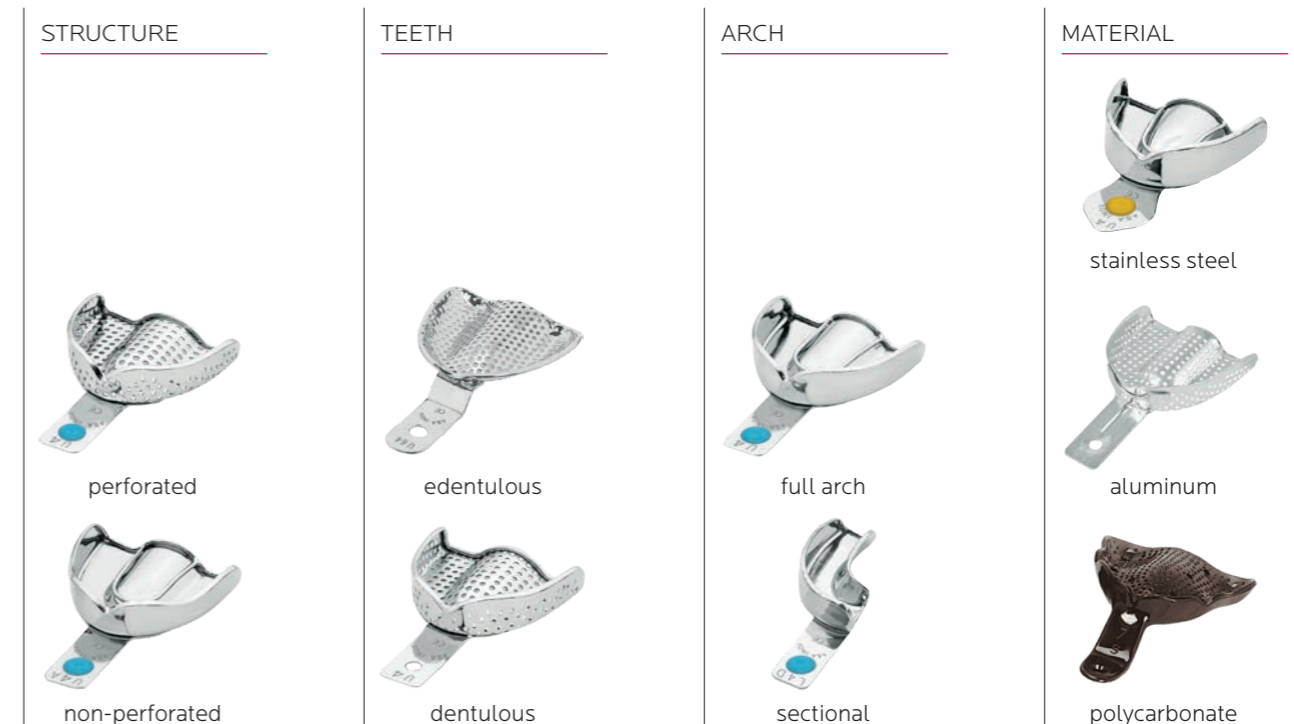

Perforated stainless steel impression trays - PERMA-LOCK

with retention rim

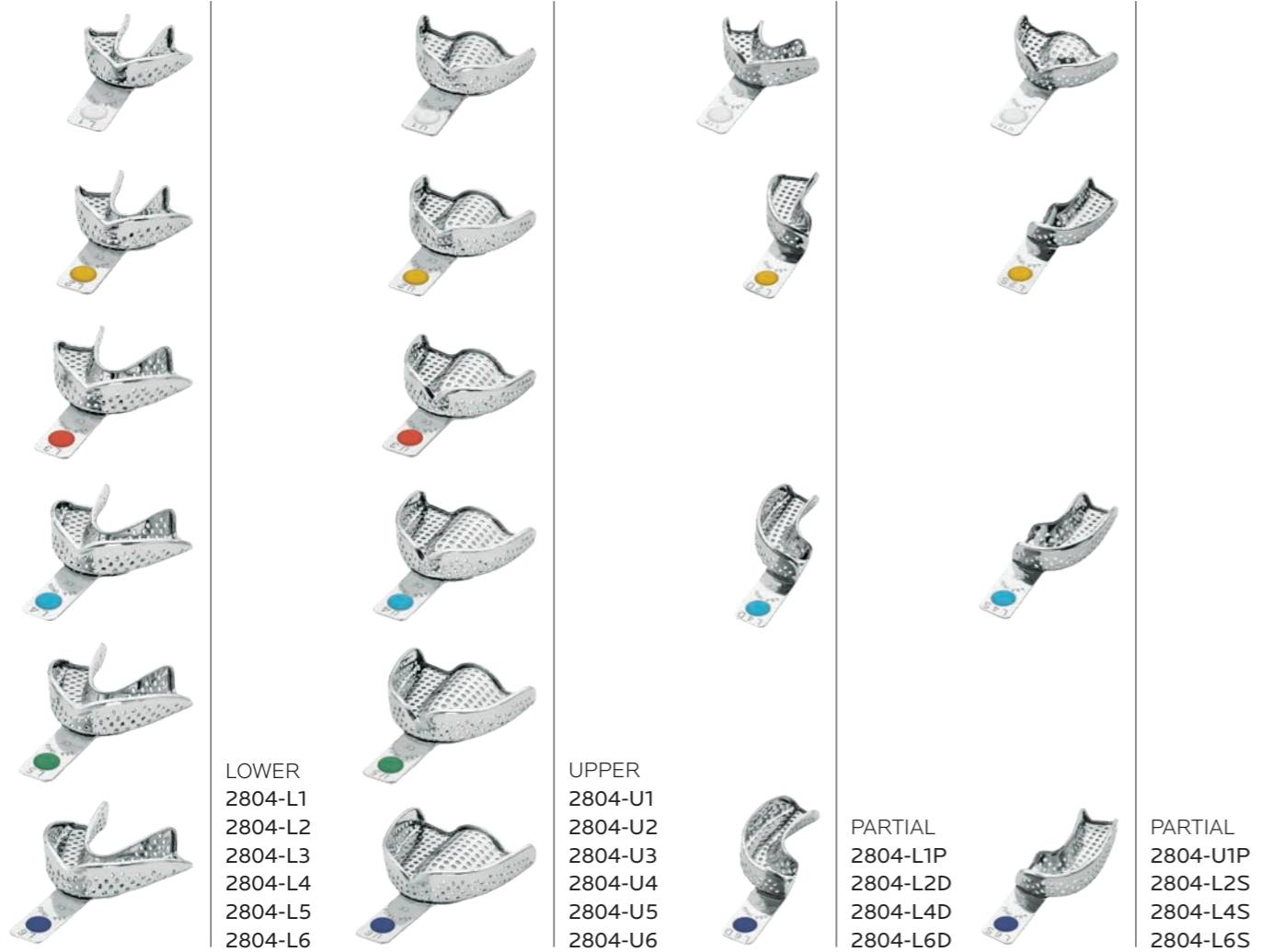

Perforated stainless steel impression trays - PERMA-LOCK

with retention rim

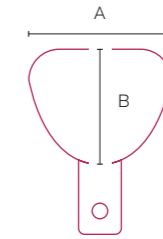
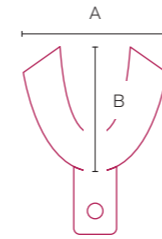

2804 UPPER		A (mm)	B (mm)
U1	XXS	61	47
U2	XS	64	51
U3	S	66	53
U4	M	69	57
U5	L	71	60
U6	XL	73	62

ASA Codicolor

- U1/L1
XXS
- U2/L2
XS
- U3/L3
S
- U4/L4
M
- U5/L5
L
- U6/L6
XL



Perforated stainless steel impression trays - PERMA-LOCK ANATOMIC

with retention rim

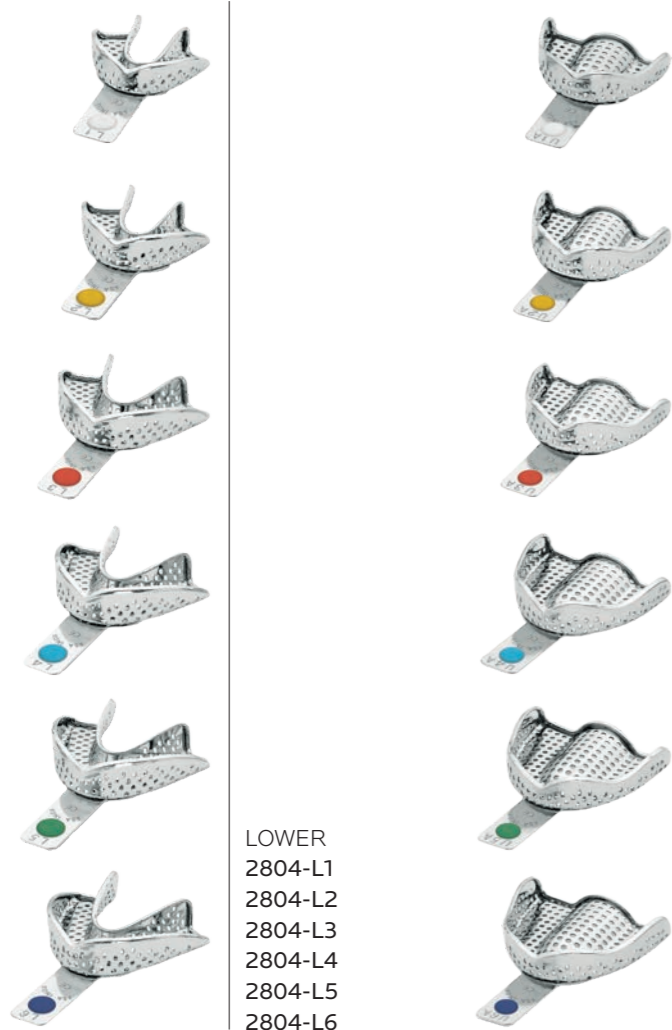

LOWER
2804-L1
2804-L2
2804-L3
2804-L4
2804-L5
2804-L6



UPPER
2804-U1A
2804-U2A
2804-U3A
2804-U4A
2804-U5A
2804-U6A

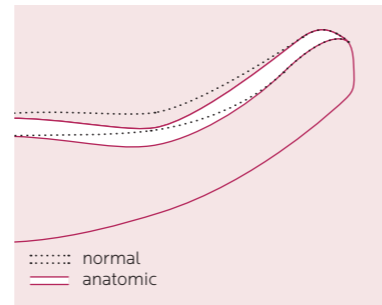

Perforated stainless steel impression trays - PERMA-LOCK ANATOMIC

with retention rim

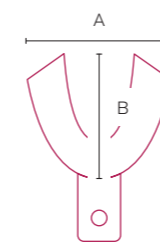

2804 LOWER		A (mm)	B (mm)
L1	XXS	55	47
L2	XS	60	49
L3	S	72	54
L4	M	74	57
L5	L	76	59
L6	XL	78	61

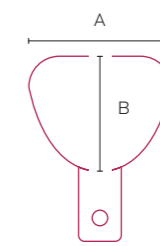

2804A UPPER		A (mm)	B (mm)
U1A	XXS	61	47
U2A	XS	64	51
U3A	S	66	53
U4A	M	69	57
U5A	L	71	60
U6A	XL	73	62



ASA Codicolor

- U1/L1
XXS
- U2/L2
XS
- U3/L3
S
- U4/L4
M
- U5/L5
L
- U6/L6
XL

Perforated stainless steel impression trays - PERMA-LOCK HIGH GRIP

with increased retention rim and internal high grip satin finish

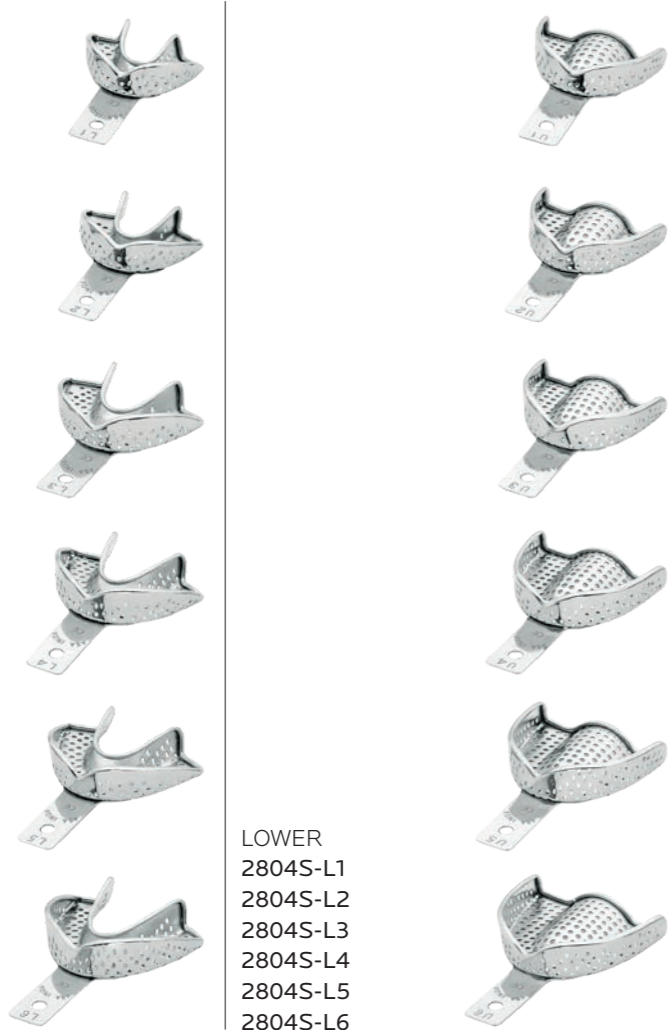

LOWER
2804S-L1
2804S-L2
2804S-L3
2804S-L4
2804S-L5
2804S-L6



UPPER
2804S-U1
2804S-U2
2804S-U3
2804S-U4
2804S-U5
2804S-U6

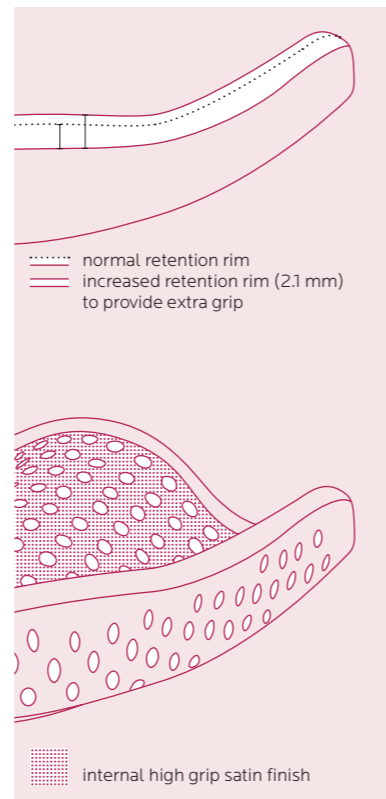

Perforated stainless steel impression trays - PERMA-LOCK HIGH GRIP

with increased retention rim and internal high grip satin finish

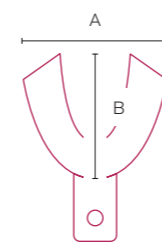

2804S LOWER		A (mm)	B (mm)
L1	XXS	55	47
L2	XS	60	49
L3	S	72	54
L4	M	74	57
L5	L	76	59
L6	XL	78	61

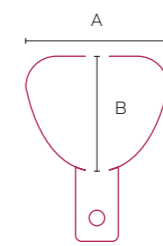

2804S UPPER		A (mm)	B (mm)
U1	XXS	61	47
U2	XS	64	51
U3	S	66	53
U4	M	69	57
U5	L	71	60
U6	XL	73	62

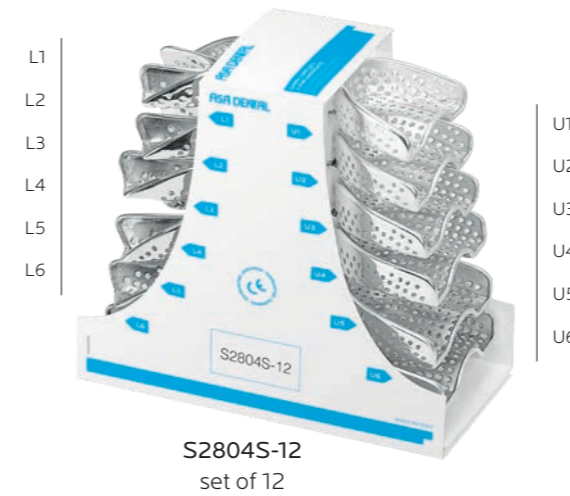

Perforated stainless steel impression trays - anterior depressed

with retention rim



LOWER
2809-L22
2809-L21
2809-L20



UPPER
2809-U7
2809-U4
2809-U1

L22
L21
L20



S2809-6
set of 6

U7
U4
U1

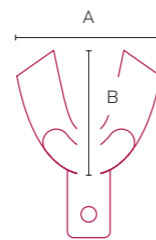

2809 LOWER		A (mm)	B (mm)
L22	S	76	54
L21	M	79	57
L20	L	81	60

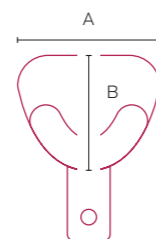

2809 UPPER		A (mm)	B (mm)
U7	S	70	57
U4	M	71	64
U1	L	81	67

Perforated stainless steel impression trays - edentulous

with retention rim



LOWER
2806-L69
2806-L68
2806-L67
2806-L66



UPPER
2806-U64
2806-U63
2806-U62
2806-U61

L69
L68
L67
L66

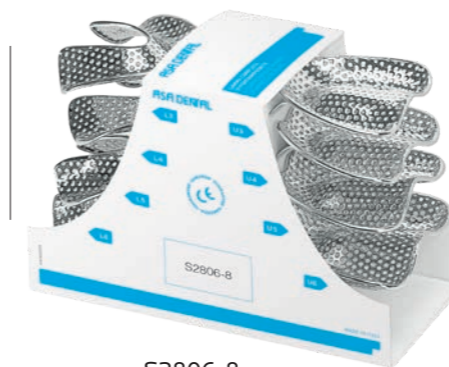

S2806-8
set of 8

U64
U63
U62
U61

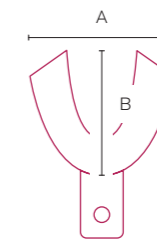

2806 LOWER		A (mm)	B (mm)
L69	S	70	57
L68	M	73	60
L67	NL	70	64
L66	L	86	64

NL: Narrow Large

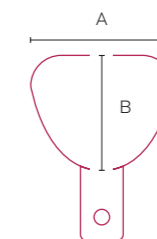

2806 UPPER		A (mm)	B (mm)
U64	S	73	60
U63	NM	70	64
U62	M	76	67
U61	L	79	70

NM: Narrow Medium

Perforated stainless steel impression trays

without retention rim

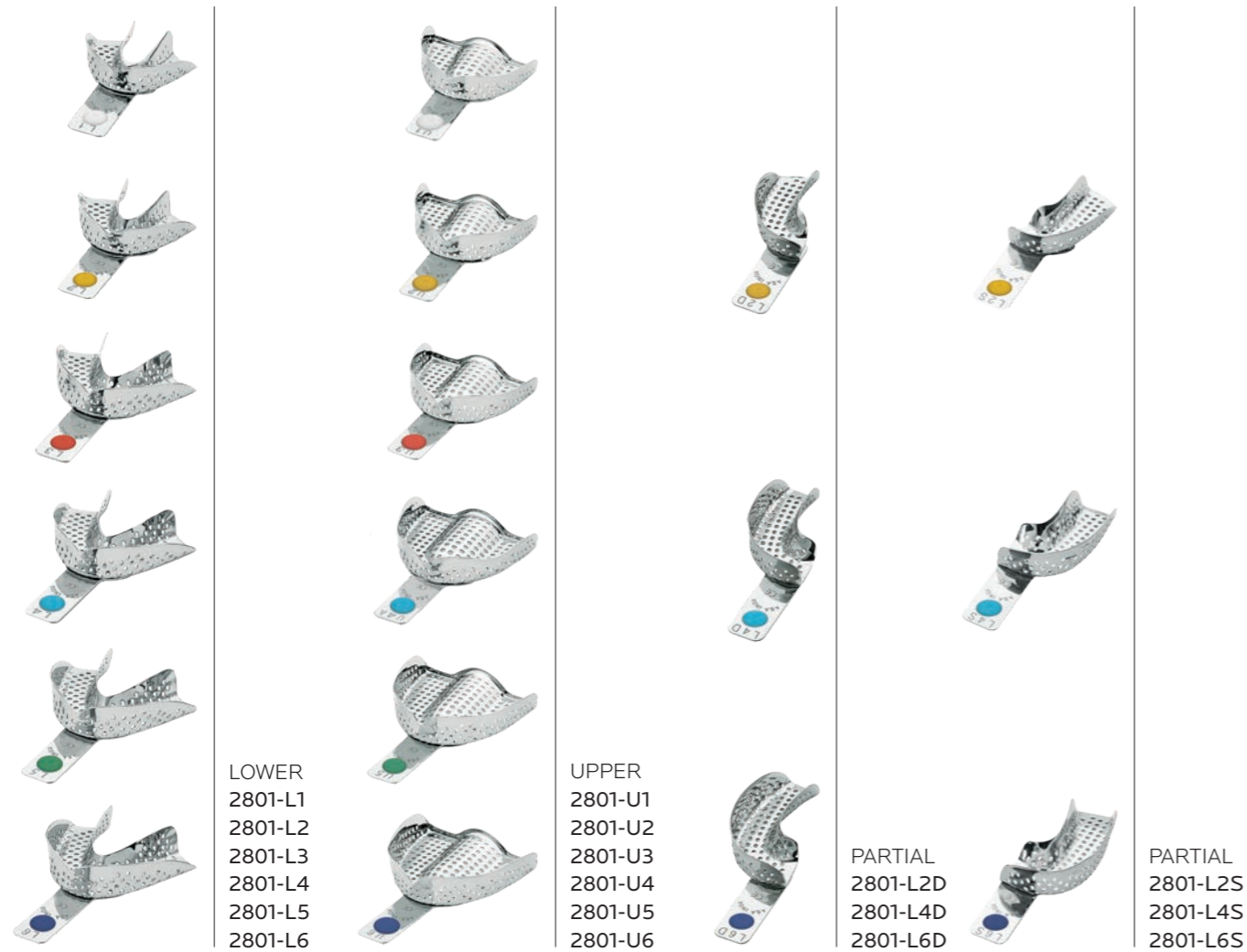
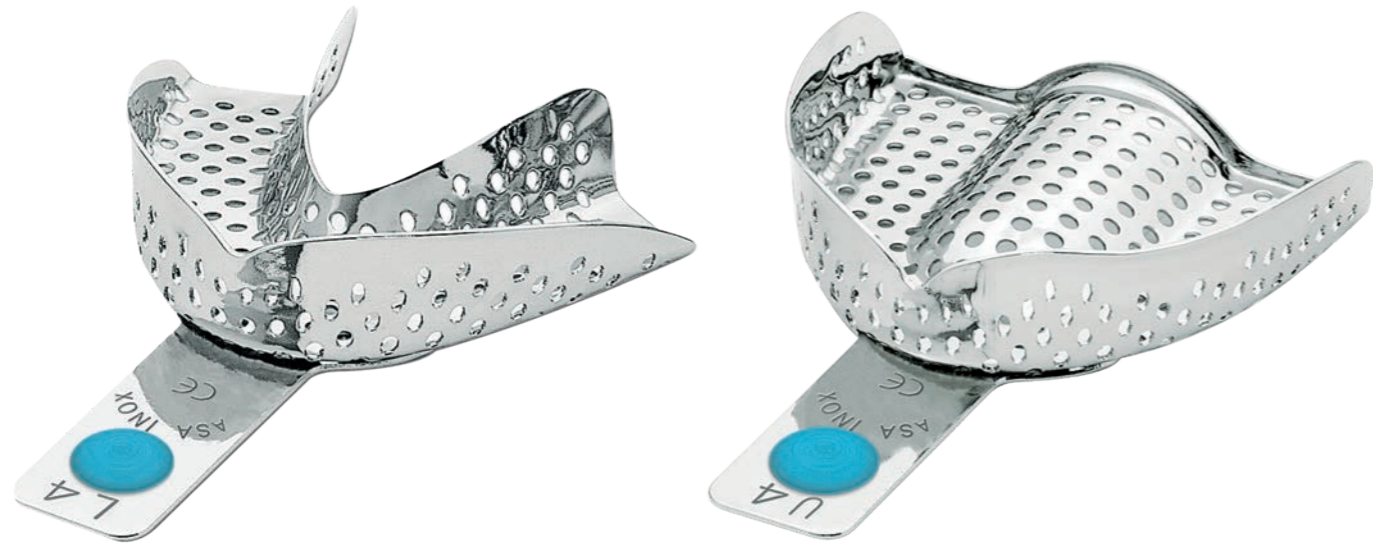

Perforated stainless steel impression trays

without retention rim

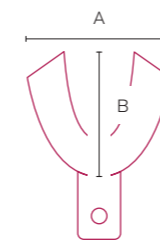

2801 LOWER		A (mm)	B (mm)
L1	XXS	55	47
L2	XS	60	49
L3	S	72	54
L4	M	74	57
L5	L	76	59
L6	XL	78	61

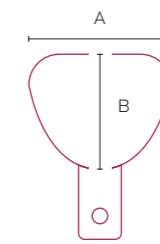

2801 UPPER		A (mm)	B (mm)
U1	XXS	61	47
U2	XS	64	51
U3	S	66	53
U4	M	69	57
U5	L	71	60
U6	XL	73	62

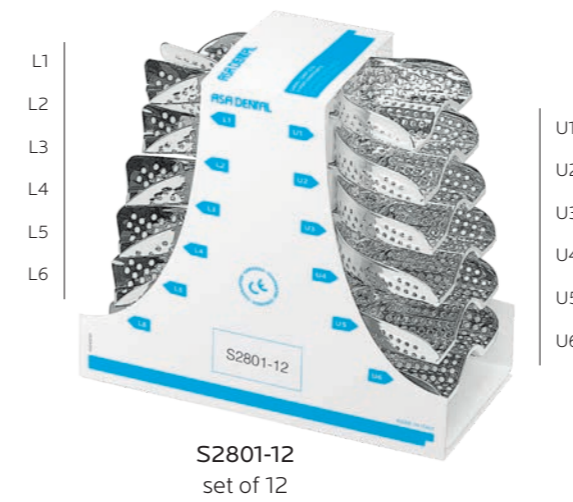

ASA Codicolor

- U1/L1**
XXS
- U2/L2**
XS
- U3/L3**
S
- U4/L4**
M
- U5/L5**
L
- U6/L6**
XL

Perforated stainless steel impression trays - ANATOMIC

without retention rim

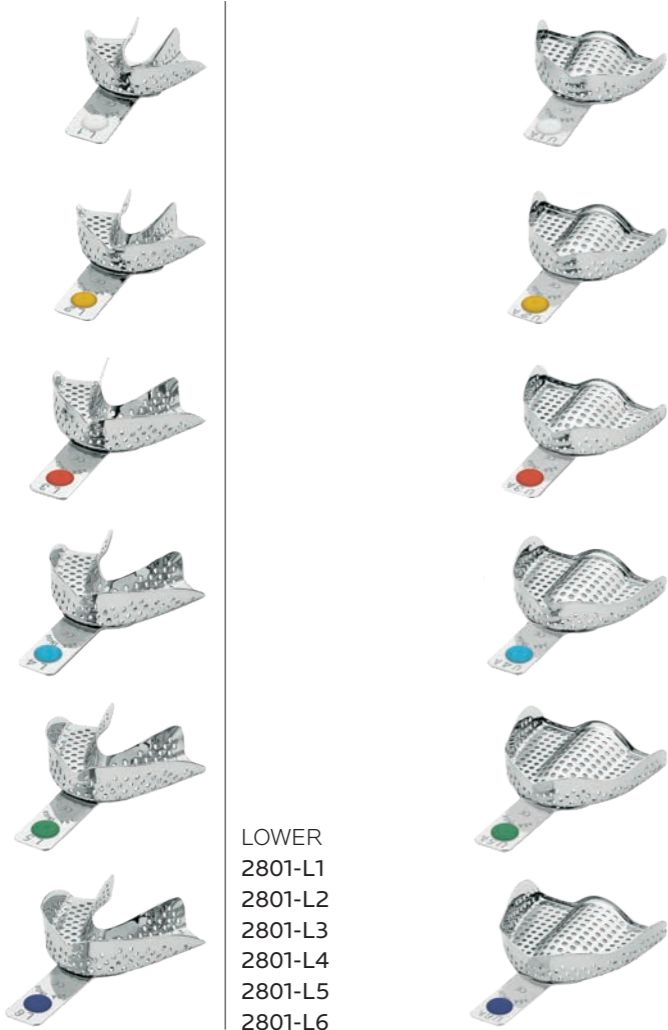

LOWER
2801-L1
2801-L2
2801-L3
2801-L4
2801-L5
2801-L6



UPPER
2801-U1A
2801-U2A
2801-U3A
2801-U4A
2801-U5A
2801-U6A

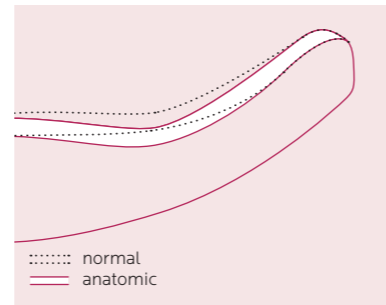

Perforated stainless steel impression trays - ANATOMIC

without retention rim

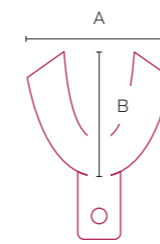

2801 LOWER		A (mm)	B (mm)
L1	XXS	55	47
L2	XS	60	49
L3	S	72	54
L4	M	74	57
L5	L	76	59
L6	XL	78	61

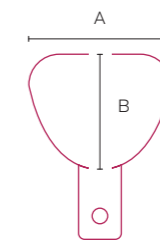

2801A UPPER		A (mm)	B (mm)
U1	XXS	61	47
U2	XS	64	51
U3	S	66	53
U4	M	69	57
U5	L	71	60
U6	XL	73	62



ASA Codicolor

- U1/L1
XXS
- U2/L2
XS
- U3/L3
S
- U4/L4
M
- U5/L5
L
- U6/L6
XL

Perforated stainless steel impression trays - Ehrlicke

without retention rim

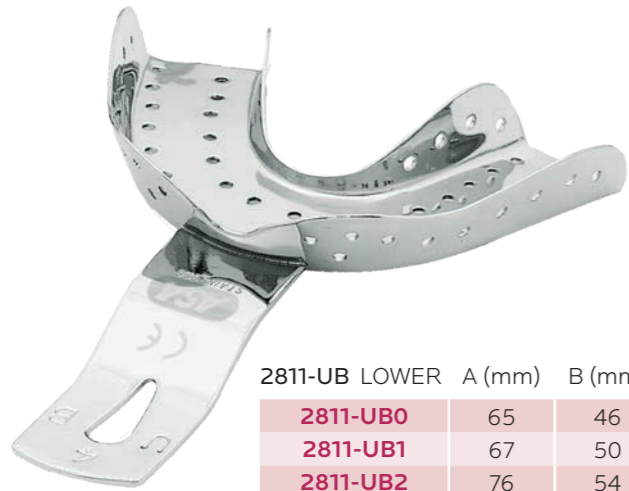
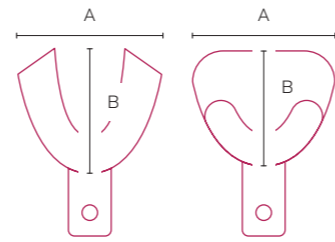

2811-UB LOWER	A (mm)	B (mm)
2811-UB0	65	46
2811-UB1	67	50
2811-UB2	76	54
2811-UB3	79	56
2811-UB4	79	61

for lower jaws, for children



2811-OB UPPER	A (mm)	B (mm)
2811-OB0	59	52
2811-OB1	66	52
2811-OB2	71	62
2811-OB3	71	64
2811-OB4	80	70

for upper jaws, for children



2811-BS UPPER	A (mm)	B (mm)
2811-BS2	70	54

for narrow upper jaws

Perforated stainless steel impression trays - Ehrlicke

without retention rim

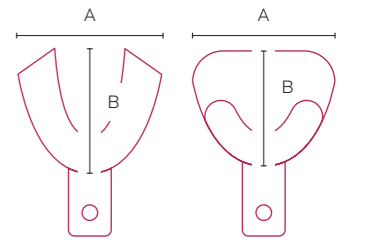

2811-UU LOWER	A (mm)	B (mm)
2811-UU1	70	48
2811-UU2	70	53
2811-UU3	72	57

for edentulous lower jaws



2811-OU UPPER	A (mm)	B (mm)
2811-OU1	64	46
2811-OU2	68	53
2811-OU3	79	61

for edentulous upper jaws



2811-UP LOWER	A (mm)	B (mm)
2811-UP1	70	55
2811-UP2	78	59

for partially toothed lower jaws

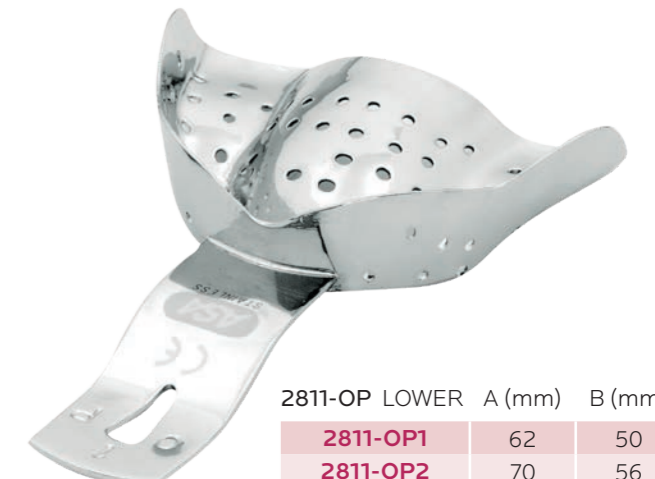

2811-OP LOWER	A (mm)	B (mm)
2811-OP1	62	50
2811-OP2	70	56

for partially toothed upper jaws



S2811-1
set of 10

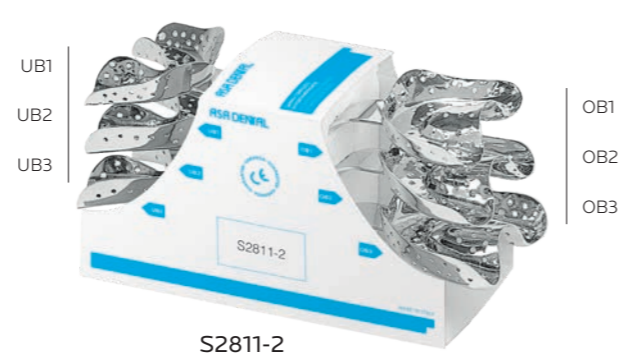

S2811-2
set of 6



S2811-3
set of 10

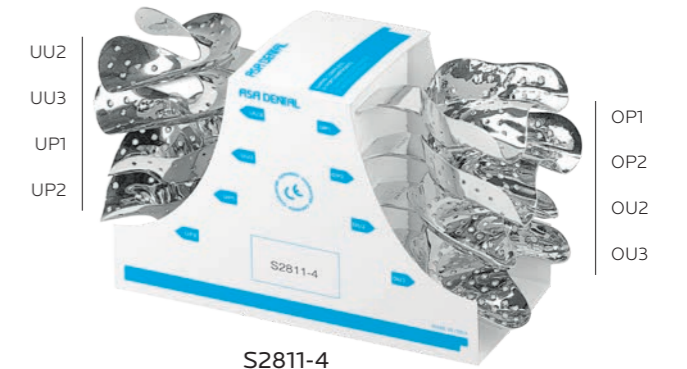

S2811-4
set of 8

Perforated stainless steel impression trays - edentulous

without retention rim



Perforated stainless steel impression trays - edentulous

without retention rim

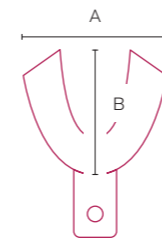

2813 LOWER		A (mm)	B (mm)
L1	XXS	60	54
L2	XS	67	55
L3	S	70	56
L4	M	74	58
L5	L	76	60
L6	XL	80	62

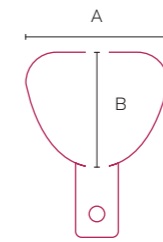

2813 UPPER		A (mm)	B (mm)
U1	XXS	60	50
U2	XS	64	54
U3	S	68	58
U4	M	70	60
U5	L	78	64



LOWER
2813-L1
2813-L2
2813-L3
2813-L4
2813-L5
2813-L6



UPPER
2813-U1
2813-U2
2813-U3
2813-U4
2813-U5



S2813
set of 11 and compass
for final impressions



MB026-1
stainless steel compass

Non-perforated stainless steel impression trays - NEW SUPER

with retention rim



Non-perforated stainless steel impression trays - NEW SUPER

with retention rim

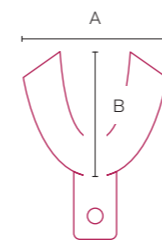



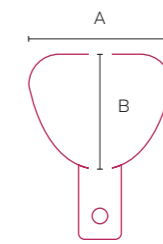

2803 LOWER		A (mm)	B (mm)
L5	XS	69	50
L4	S	72	57
L3	M	76	57
L2	L	78	59
L1	XL	80	63



2803 UPPER		A (mm)	B (mm)
U5	XS	65	51
U4	S	67	53
U3	M	71	55
U2	L	74	60
U1	XL	81	63

ASA Codicolor

-  **U5/L5**
XS
-  **U4/L4**
S
-  **U3/L3**
M
-  **U2/L2**
L
-  **U1/L1**
XL



- LOWER
- 2803-L5
- 2803-L4
- 2803-L3
- 2803-L2
- 2803-L1



- UPPER
- 2803-U5
- 2803-U4
- 2803-U3
- 2803-U2
- 2803-U1



Non-perforated stainless steel impression trays - PERMA-LOCK

with retention rim

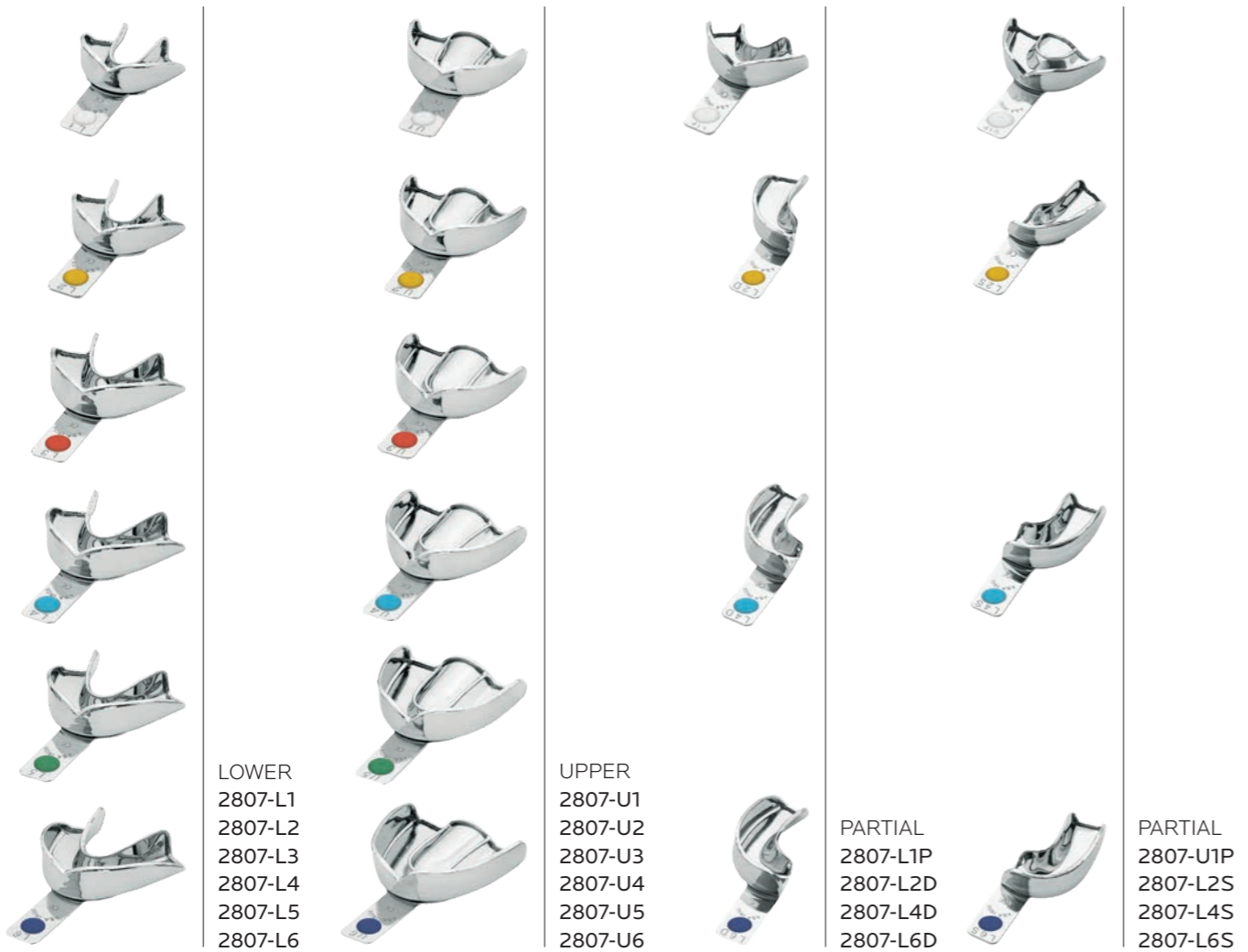

LOWER
2807-L1
2807-L2
2807-L3
2807-L4
2807-L5
2807-L6

UPPER
2807-U1
2807-U2
2807-U3
2807-U4
2807-U5
2807-U6

PARTIAL
2807-L1P
2807-L2D
2807-L4D
2807-L6D

PARTIAL
2807-U1P
2807-L2S
2807-L4S
2807-L6S

Non-perforated stainless steel impression trays - PERMA-LOCK

with retention rim

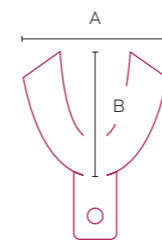

2807 LOWER		A (mm)	B (mm)
L1	XXS	55	47
L2	XS	60	49
L3	S	72	54
L4	M	74	57
L5	L	76	59
L6	XL	78	61

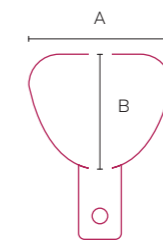

2807 UPPER		A (mm)	B (mm)
U1	XXS	61	47
U2	XS	64	51
U3	S	66	53
U4	M	69	57
U5	L	71	60
U6	XL	73	62



ASA Codicolor

- U1/L1
XXS
- U2/L2
XS
- U3/L3
S
- U4/L4
M
- U5/L5
L
- U6/L6
XL

Non-perforated stainless steel impression trays - PERMA-LOCK ANATOMIC

with retention rim

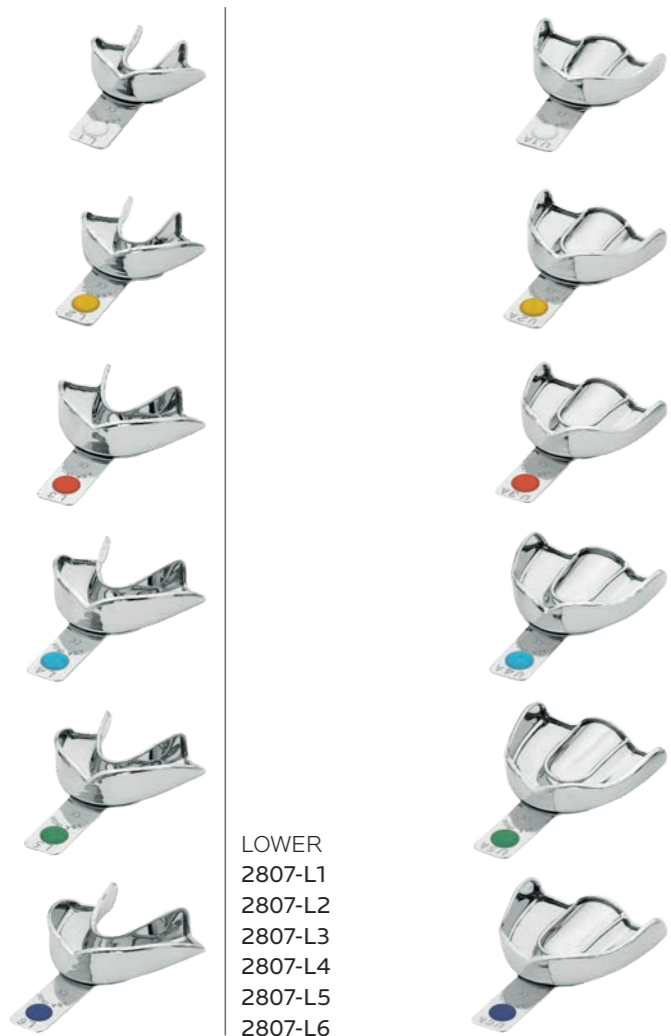

LOWER
2807-L1
2807-L2
2807-L3
2807-L4
2807-L5
2807-L6



UPPER
2807-U1A
2807-U2A
2807-U3A
2807-U4A
2807-U5A
2807-U6A

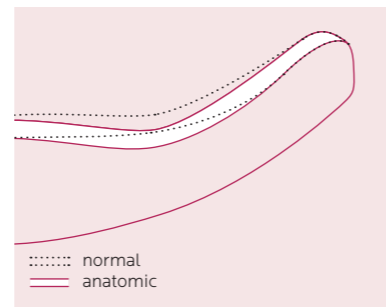

Non-perforated stainless steel impression trays - PERMA-LOCK ANATOMIC

with retention rim

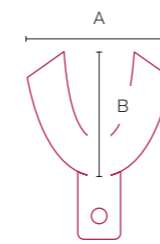

2807 LOWER		A (mm)	B (mm)
L1	XXS	55	47
L2	XS	60	49
L3	S	72	54
L4	M	74	57
L5	L	76	59
L6	XL	78	61

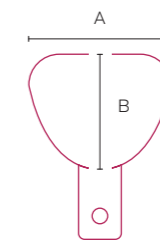

2807A UPPER		A (mm)	B (mm)
U1A	XXS	61	47
U2A	XS	64	51
U3A	S	66	53
U4A	M	69	57
U5A	L	71	60
U6A	XL	73	62



S2807A-12
set of 12



S2807A-8
set of 8



S2807A-6
set of 6

ASA Codicolor

- U1/L1
XXS
- U2/L2
XS
- U3/L3
S
- U4/L4
M
- U5/L5
L
- U6/L6
XL

Non-perforated stainless steel impression trays - PERMA-LOCK HIGH GRIP

with increased retention rim and internal high grip satin finish



Non-perforated stainless steel impression trays - PERMA-LOCK HIGH GRIP

with increased retention rim and internal high grip satin finish

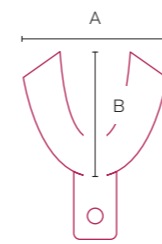

2807S LOWER		A (mm)	B (mm)
L1	XXS	55	47
L2	XS	60	49
L3	S	72	54
L4	M	75	57
L5	L	76	59
L6	XL	78	61

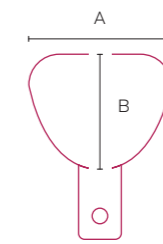

2807S UPPER		A (mm)	B (mm)
U1	XXS	61	47
U2	XS	64	51
U3	S	66	53
U4	M	69	57
U5	L	71	60
U6	XL	73	62

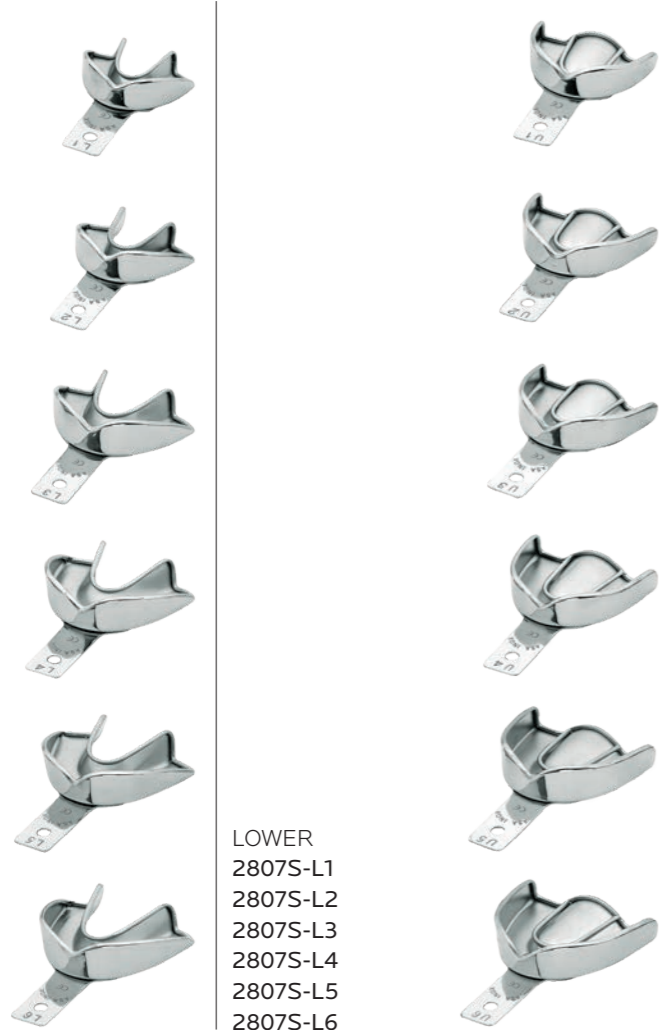

LOWER
2807S-L1
2807S-L2
2807S-L3
2807S-L4
2807S-L5
2807S-L6



UPPER
2807S-U1
2807S-U2
2807S-U3
2807S-U4
2807S-U5
2807S-U6

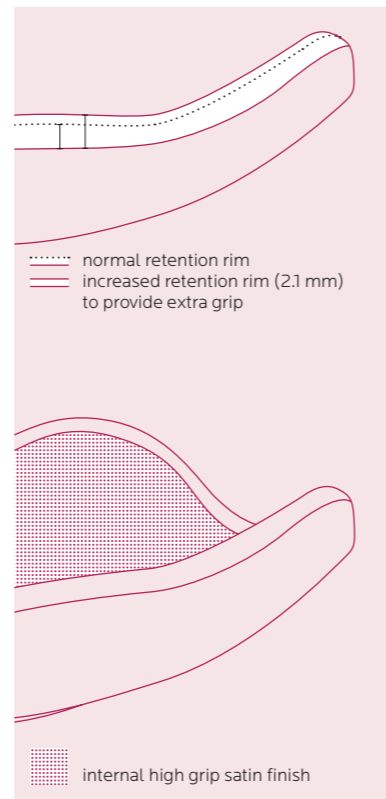

S2807S-12
set of 12



S2807S-8
set of 8



S2807S-6
set of 6

Non-perforated stainless steel impression trays - anterior depressed

with retention rim



LOWER
2810-L22
2810-L21
2810-L20



UPPER
2810-U7
2810-U4
2810-U1

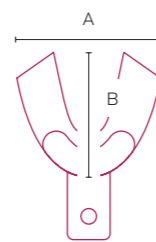

2810 LOWER		A (mm)	B (mm)
L22	S	76	54
L21	M	79	57
L20	L	81	60

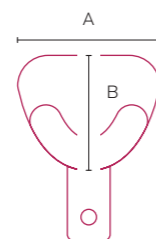

2810 UPPER		A (mm)	B (mm)
U7	S	70	57
U4	M	71	64
U1	L	81	67

Non-perforated stainless steel impression trays - edentulous

with retention rim



LOWER
2808-L69
2808-L68
2808-L67
2808-L66



UPPER
2808-U64
2808-U63
2808-U62
2808-U61

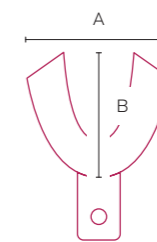

2808 LOWER		A (mm)	B (mm)
L69	S	70	57
L68	M	73	60
L67	NL	70	64
L66	L	86	64

NL: Narrow Large

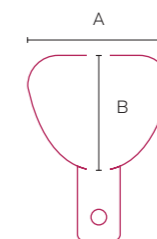

2808 UPPER		A (mm)	B (mm)
U64	S	73	60
U63	NM	70	64
U62	M	76	67
U61	L	79	70

NM: Narrow Medium

Non-perforated stainless steel impression trays - NEW SUPER HIGH GRIP

with increased retention rim and internal high grip satin finish



Non-perforated stainless steel impression trays - NEW SUPER HIGH GRIP

with increased retention rim and internal high grip satin finish

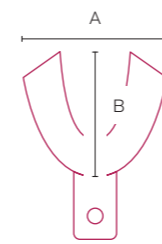

2803S LOWER		A (mm)	B (mm)
L5	XS	69	50
L4	S	72	57
L3	M	76	57
L2	L	78	59
L1	XL	80	63

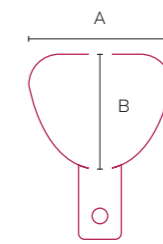

2803S UPPER		A (mm)	B (mm)
U5	XS	65	51
U4	S	67	53
U3	M	71	55
U2	L	74	60
U1	XL	81	63

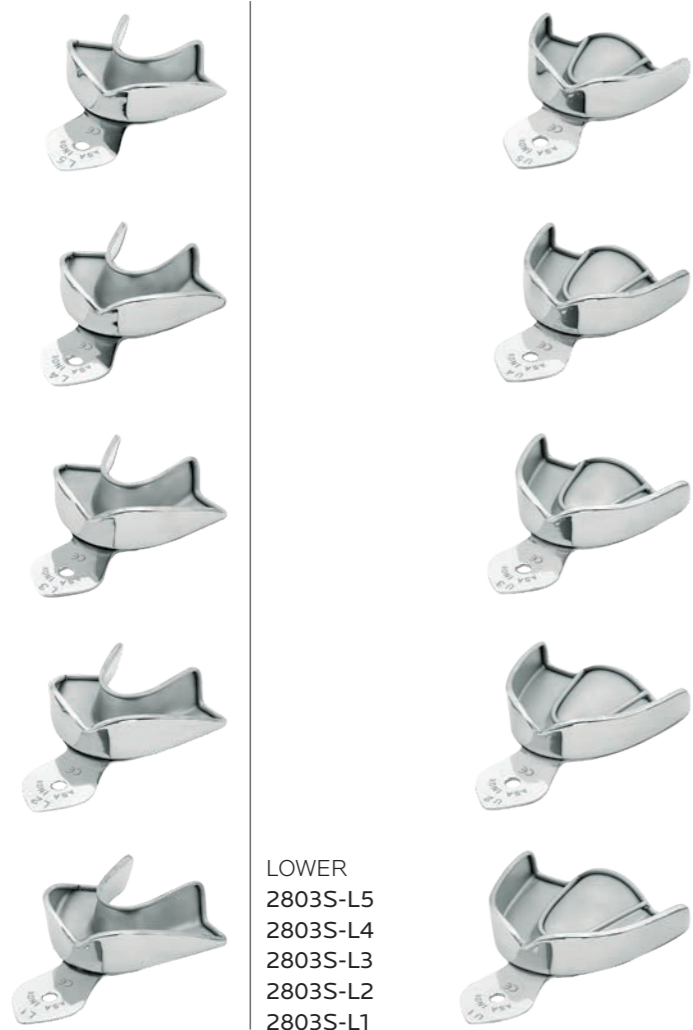

LOWER
2803S-L5
2803S-L4
2803S-L3
2803S-L2
2803S-L1

UPPER
2803S-U5
2803S-U4
2803S-U3
2803S-U2
2803S-U1

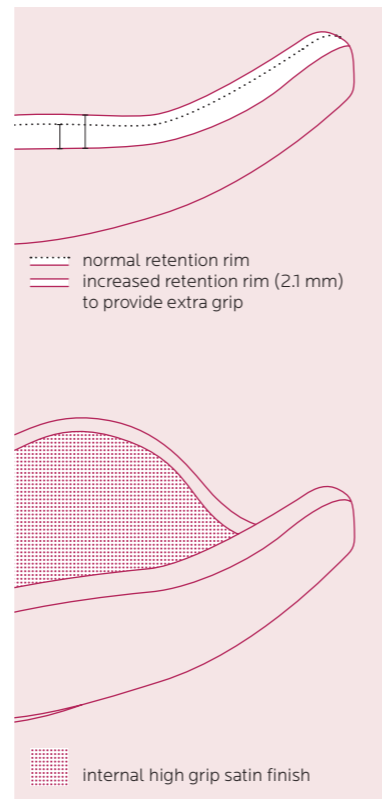

Non-perforated stainless steel impression trays

without retention rim

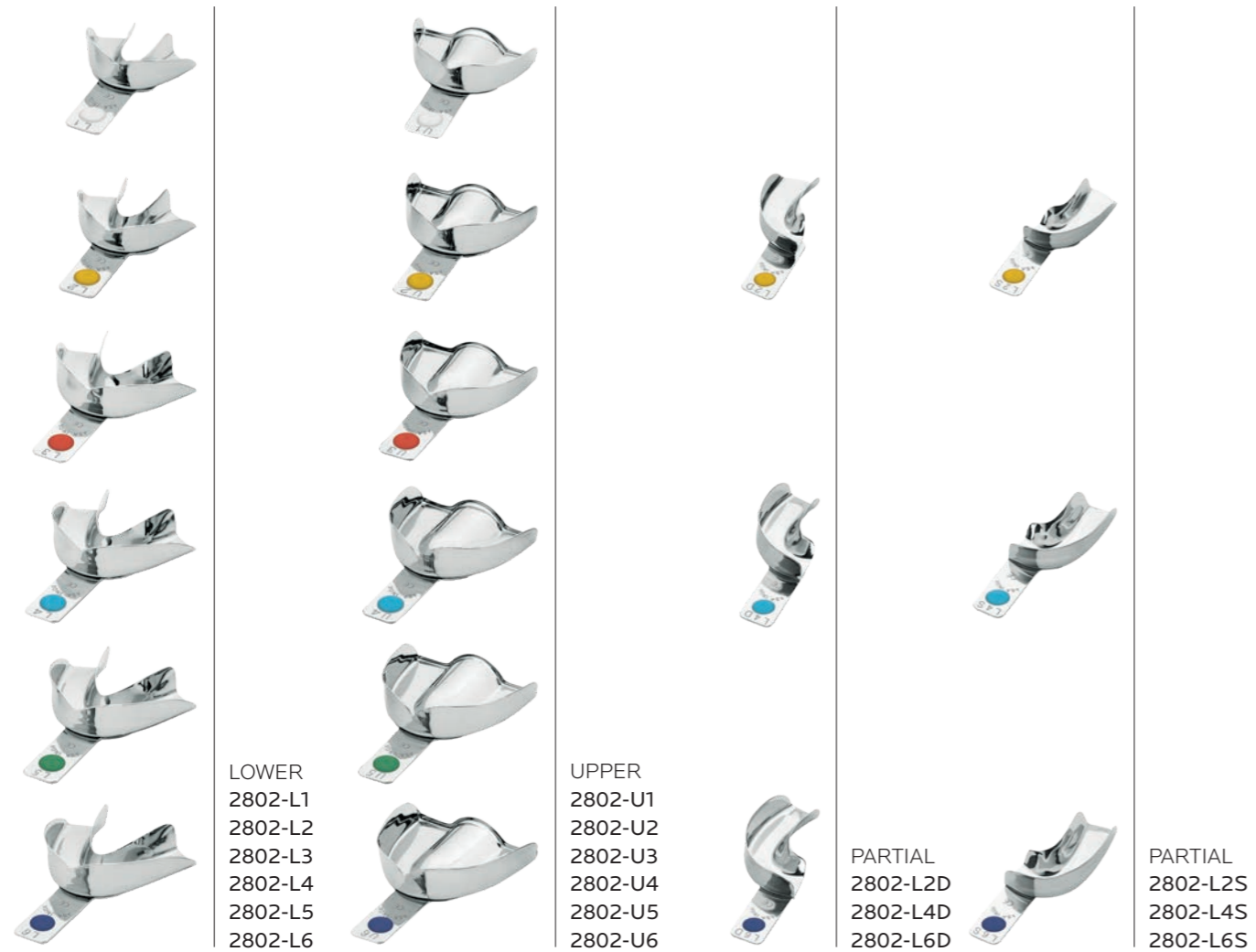

LOWER
2802-L1
2802-L2
2802-L3
2802-L4
2802-L5
2802-L6

UPPER
2802-U1
2802-U2
2802-U3
2802-U4
2802-U5
2802-U6

PARTIAL
2802-L2D
2802-L4D
2802-L6D

PARTIAL
2802-L2S
2802-L4S
2802-L6S

Non-perforated stainless steel impression trays

without retention rim

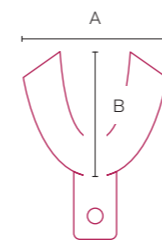

2802 LOWER		A (mm)	B (mm)
L1	XXS	55	47
L2	XS	60	49
L3	S	72	54
L4	M	74	57
L5	L	76	59
L6	XL	78	61

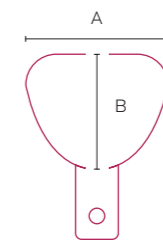

2802 UPPER		A (mm)	B (mm)
U1	XXS	61	47
U2	XS	64	51
U3	S	66	53
U4	M	69	57
U5	L	71	60
U6	XL	73	62



S2802-12
set of 12



S2802-8
set of 8



S2802-6
set of 6

ASA Codicolor

- U1/L1
XXS
- U2/L2
XS
- U3/L3
S
- U4/L4
M
- U5/L5
L
- U6/L6
XL

Non-perforated stainless steel impression trays - ANATOMIC

without retention rim

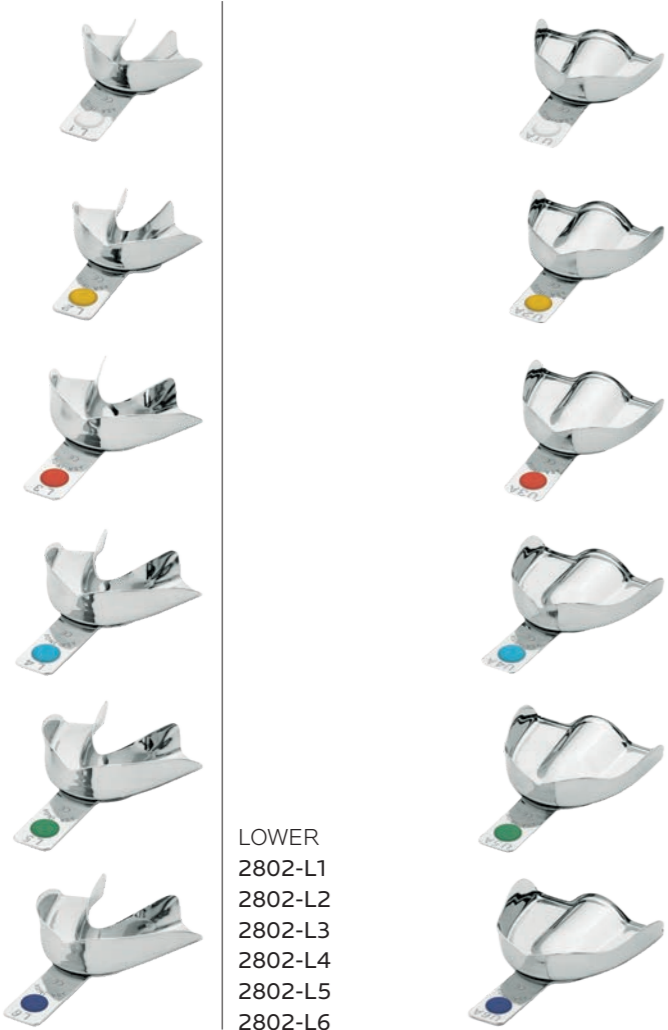

- LOWER
- 2802-L1
- 2802-L2
- 2802-L3
- 2802-L4
- 2802-L5
- 2802-L6



- UPPER
- 2802-U1A
- 2802-U2A
- 2802-U3A
- 2802-U4A
- 2802-U5A
- 2802-U6A

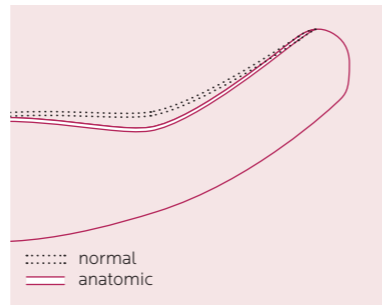

Non-perforated stainless steel impression trays - ANATOMIC

without retention rim

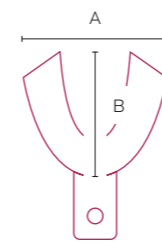

2802 LOWER		A (mm)	B (mm)
L1	XXS	55	47
L2	XS	60	49
L3	S	72	54
L4	M	74	57
L5	L	76	59
L6	XL	78	61

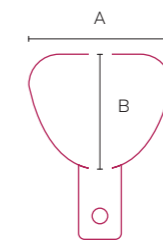

2802A UPPER		A (mm)	B (mm)
U1A	XXS	61	47
U2A	XS	64	51
U3A	S	66	53
U4A	M	69	57
U5A	L	71	60
U6A	XL	73	62



ASA Codicolor

- U1/L1
XXS
- U2/L2
XS
- U3/L3
S
- U4/L4
M
- U5/L5
L
- U6/L6
XL

Perforated aluminum impression trays

without retention rim

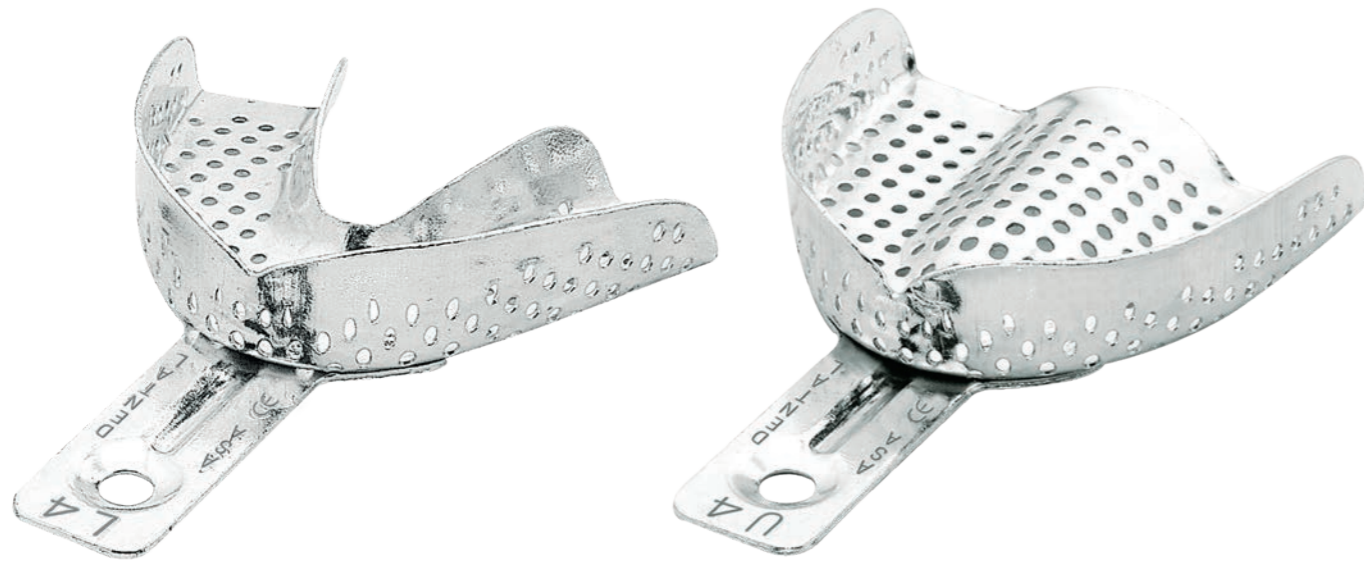

Perforated aluminum impression trays

without retention rim

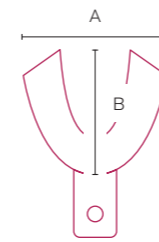

2800 LOWER		A (mm)	B (mm)
L1	XXS	56	48
L2	XS	59	50
L3	S	72	52
L4	M	76	57
L5	L	77	56
L6	XL	78	59

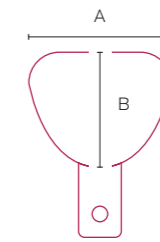

2800 UPPER		A (mm)	B (mm)
U1	XXS	63	48
U2	XS	66	51
U3	S	68	54
U4	M	71	58
U5	L	74	62
U6	XL	76	63

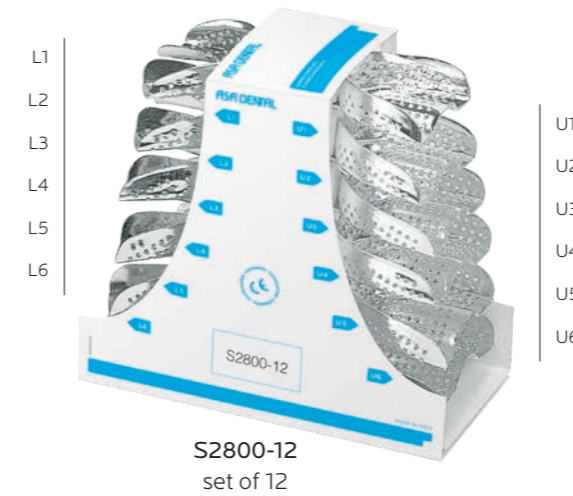
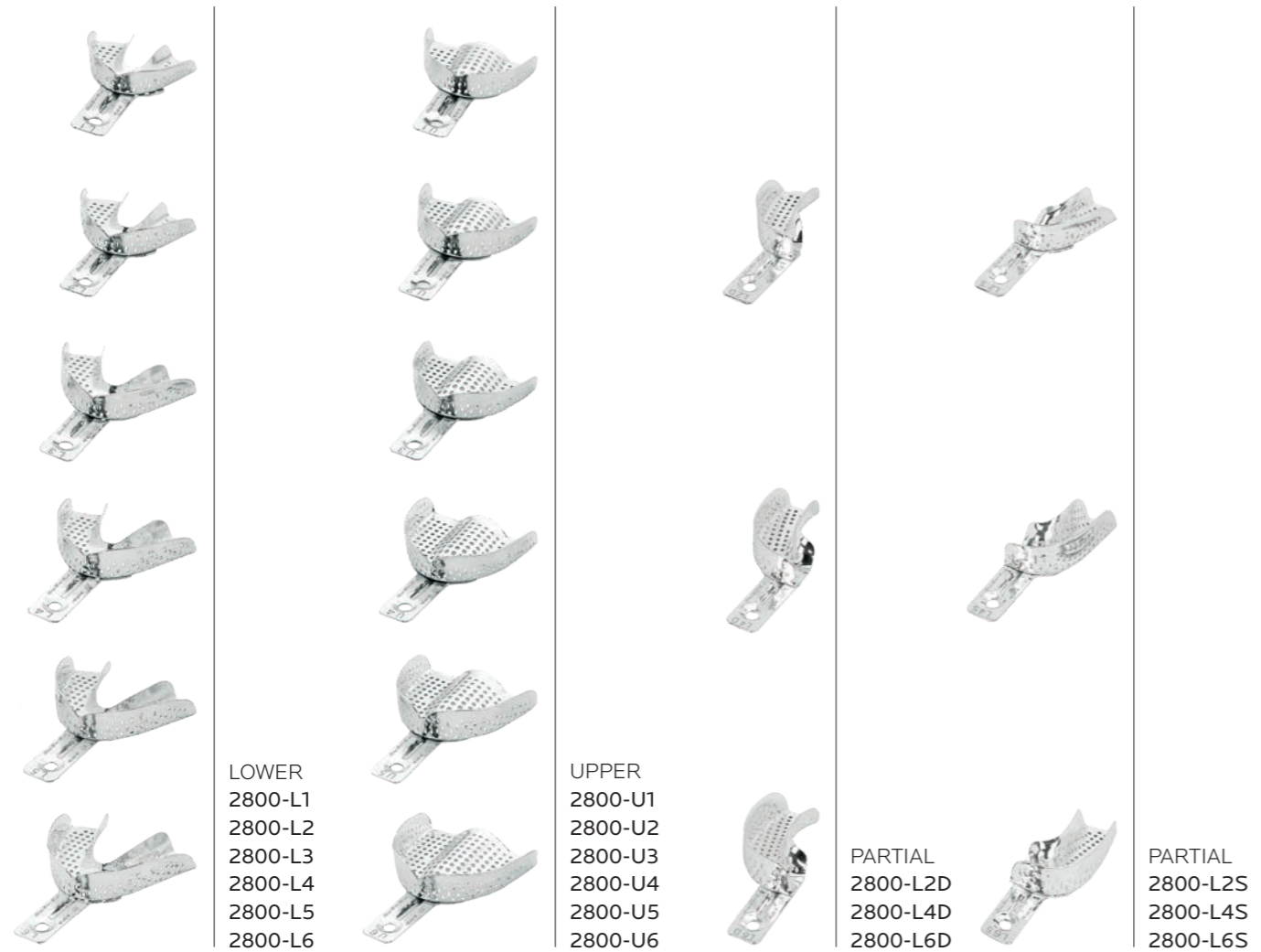

Perforated aluminum impression trays for implantology

without retention rim

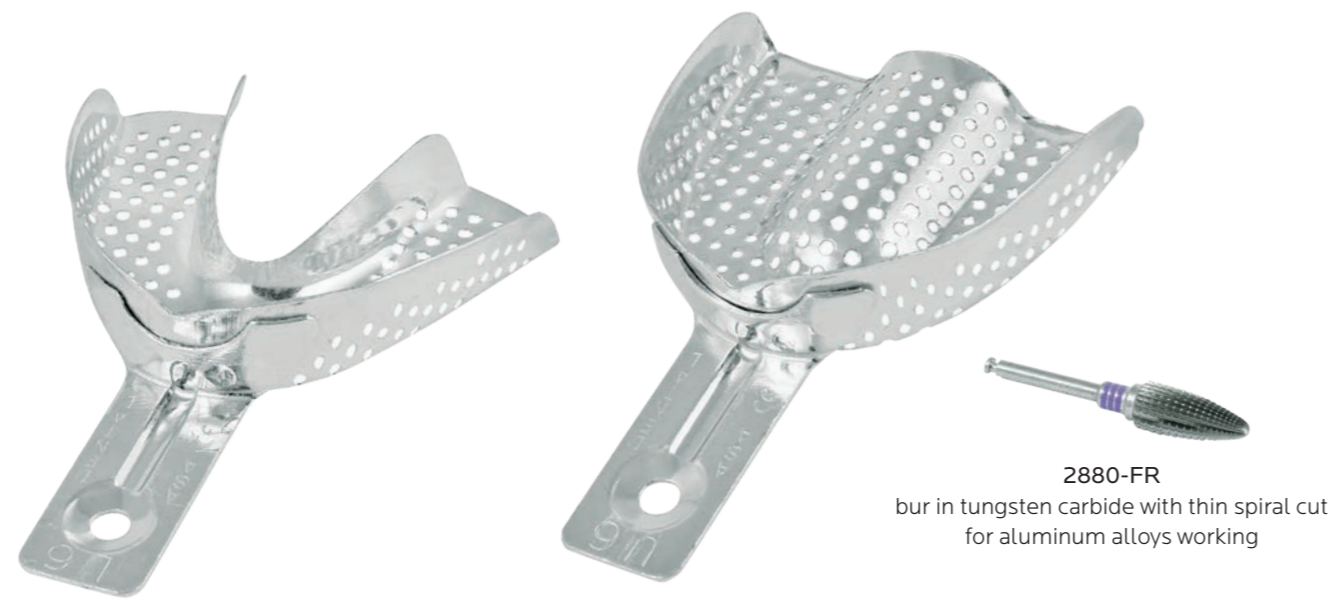

2880-FR

bur in tungsten carbide with thin spiral cut for aluminum alloys working



S2880-12 set of 12
S2880-12FR set of 12 plus bur

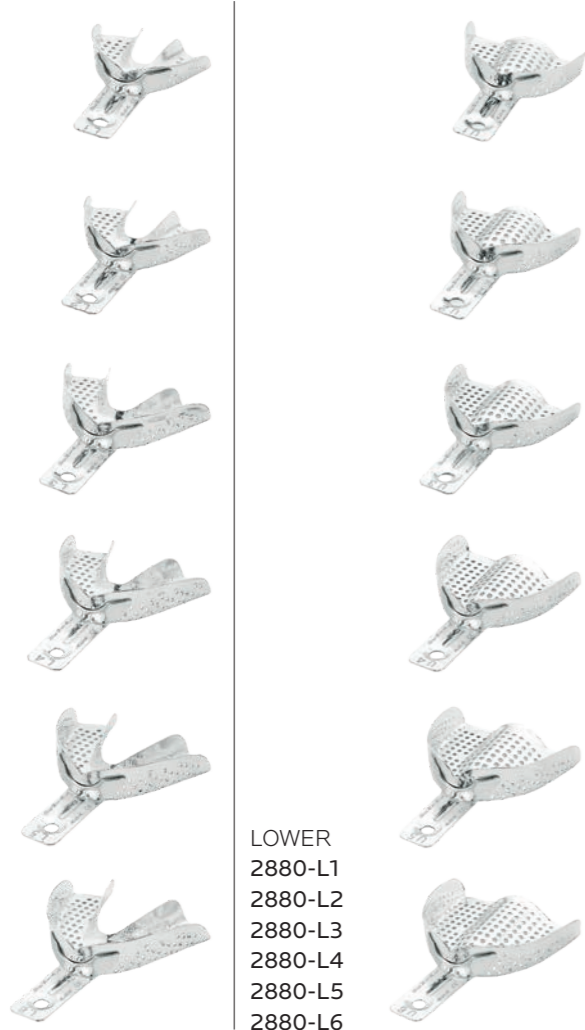

LOWER
2880-L1
2880-L2
2880-L3
2880-L4
2880-L5
2880-L6

UPPER
2880-U1
2880-U2
2880-U3
2880-U4
2880-U5
2880-U6

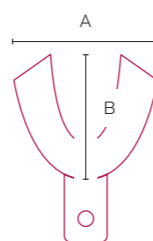

2880 LOWER		A (mm)	B (mm)
L1	XXS	56	48
L2	XS	59	50
L3	S	72	52
L4	M	76	57
L5	L	77	56
L6	XL	78	59

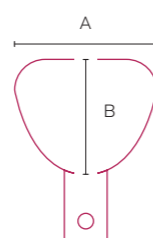

2880 UPPER		A (mm)	B (mm)
U1	XXS	63	48
U2	XS	66	51
U3	S	68	54
U4	M	71	58
U5	L	74	62
U6	XL	76	63

Perforated aluminum impression trays - ORTHOBABY for children

without retention rim

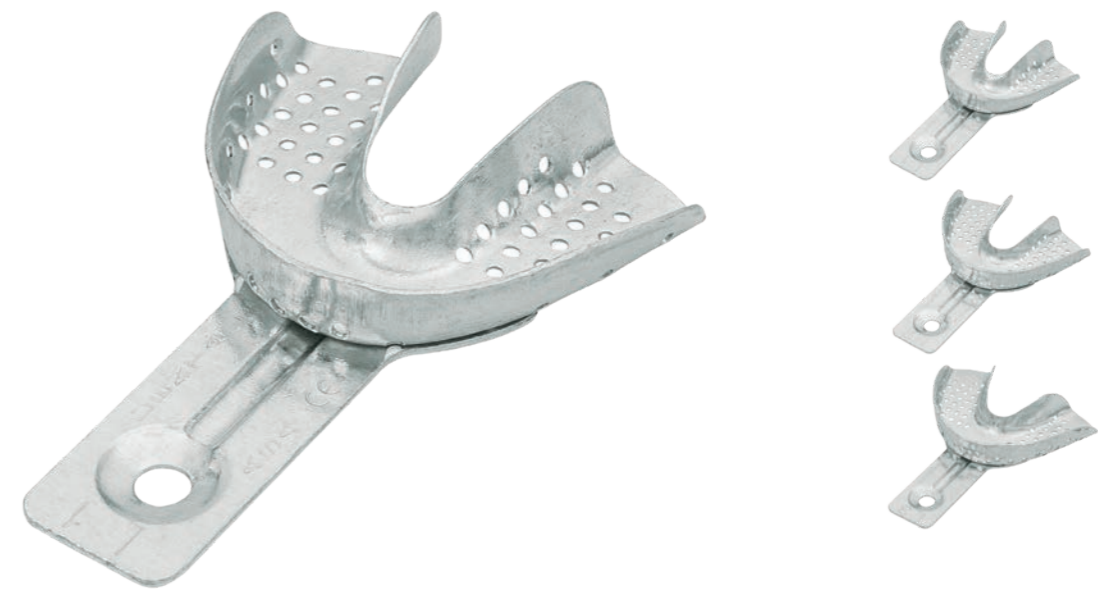

LOWER
2816-L1
2816-L2
2816-L3



UPPER
2816-U1
2816-U2
2816-U3



S2816-6 set of 6

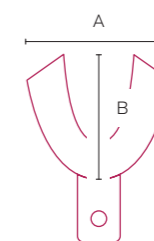

2816 LOWER		A (mm)	B (mm)
L1	S	55	45
L2	M	60	48
L3	L	69	48

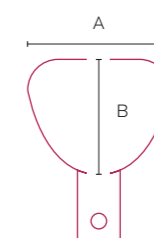

2816 UPPER		A (mm)	B (mm)
U1	S	57	38
U2	M	58	48
U3	L	63	50

Partial occlusal stainless steel impression trays

they allow you to take an impression of two semi-arches antagonistic



2819-OCC



2819-OCP

AsaClean

PH neutral solution to facilitate removal of alginate impression material from impression trays and instruments



8020
content 1000 ml

Perforated colour-coded aluminum impression trays for implantology

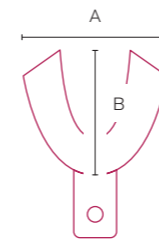

2814 LOWER		A (mm)	B (mm)
L0	XS	69	50
L1	S	72	57
L2	M	76	57
L3	L	78	59
L4	XL	80	63

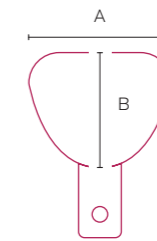

2814 UPPER		A (mm)	B (mm)
U0	XS	65	51
U1	S	67	53
U2	M	71	55
U3	L	74	60
U4	XL	81	63



LOWER
2814-L0
2814-L1
2814-L2
2814-L3
2814-L4



UPPER
2814-U0
2814-U1
2814-U2
2814-U3
2814-U4

Polycarbonate impression trays

2852-12
set of 12

LOWER

	A (mm)	B (mm)
L1	61	50
L2	67	52
L3	72	56
L4	74	58

UPPER

	A (mm)	B (mm)
U1	61	49
U2	65	53
U3	70	59
U4	73	6

LOWER

L1
L2
L3
L4
L5
L6

UPPER

U1
U2
U3
U4
U5
U6

PARTIAL

L1S
L2S
L1D
L2D

Polycarbonate impression trays - edentulous

autoclavable max. 130°C



S2851-24
set of 24
13x lower
7x upper
4x mixed
compass

2851-13
set of 13
13x lower

2851-7
set of 7
7x upper

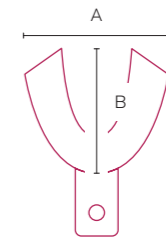

LOWER	A (mm)	B (mm)
L1	57	49
L2	58	53
L3	60	54
L4	61	55
L5	61	56
L6	61	57
L7	62	57
L8	64	55
L9	64	59
L10	66	57
L11	65	60
L12	67	58
L13	70	59

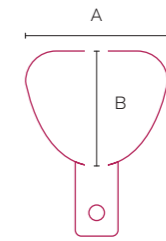

UPPER	A (mm)	B (mm)
U1	62	54
U2	63	58
U3	64	58
U4	66	60
U5	70	62
U6	75	63
U7	77	64

MIXED	A (mm)	B (mm)
U1P	64	63
U2P	67	57
L1C	75	49
L2C	76	53

Orthodontic polycarbonate impression trays - ORTHOBABY for children

2850-8
set of 8

LOWER

	A (mm)	B (mm)
L1	52	44
L2	58	49
L3	62	53
L4	66	56

UPPER

	A (mm)	B (mm)
U1	50	46
U2	56	51
U3	59	55
U4	63	59

LOWER

L1
L2
L3
L4
L5
L6

UPPER

U1
U2
U3
U4
U5
U6

LOWER

L1
L2
L3
L4
L5
L6
L7

UPPER

U1
U2
U3
U4
U5
U6
U7

MIXED

L1C
L2C
U1P
U2P



LABORATORY INSTRUMENTS

MADE IN ITALY

SKILLS AND TOOLS

No matter how good a dentist is, in order to work the magic and transform impressions into successful dental prostheses, a behind-the-scene activity from a qualified dental technician is fundamental.

Based on detailed prescriptions that include anatomical information, your job as a technician is to combine a mix of technological expertise, artistic skills, state-of-the-art materials and precise instruments to carefully create crowns, bridges, partial, removable and full dentures and more.

Asa Dental Laboratory instruments range from highly versatile articulators to precise carving instruments, through a wide range of accessories; all necessary to shape materials and make sure you can confidently help dentists restore both function and aesthetics of a patient's mouth.

- K2 Articulators
- K10 Easy Bow
- K13 Wax carvers
- K18 Waxing instruments
- K19 Tweezers
- K20 Ceramic sculpturing brushes
- K21 Ceramic sculpturing instruments
- K22 Knives
- K24 Spatulas and bowls
- K27 Prothesis boxes
- K28 Scissors
- K29 Crown instruments
- K30 Calipers
- K31 Mallets
- K32 Crucible tongs
- K33 Saws and Blades
- K34 Kits



ARTICULATORS average values

5050 and 5050Plus are non-Arcon average value articulators designed to help dental technicians meet dentists' requests for high precision regardless of the prosthetic technique. A light, stable and ergonomic construction facilitates set-up and work on any models. Additional features guarantee an exact simulation of the condylar path with a high fitting accuracy, giving prosthesis and restorations the necessary occlusion and function throughout the full range of mandibular movements.

5050 can conveniently work with dentures of many different sizes and any electronic pressure polymerizers available on the market. Designed to obtain optimal ergonomics, it offers complete stability when the technician comfortably works at 60° or upside down, in case of class III edentulous patients. The anti-rotational system for the incisal rod ensures that positioning is always correct and accurate, while the back blocking systems allows removing the rod and conveniently working on incisors. When the technique requires starting from one of the upper arches, the mounting plate helps regardless the size of the arch with clear indication of elliptic references.

FEATURES

- stable 60° operation for technician comfort
- ideal for class III patients
- compatible with any pressure polymerizers
- anti-rotation system for incisal rod
- template with 4 elliptic references for lower arch models
- occlusal table with 4 elliptic references for upper arch models
- bearing rod for 180° opening
- hinge rod with anti-shock protection system

TECHNICAL DATA

intercondylar distance	110 mm
condylar inclination fixed at	30°
Bennett angle	0 - 7°
incisal table inclination	10°
distance between mounting plates	87 mm
opening	180°

EQUIPMENT

4 mounting plates	5000-1
2 locking knobs	5011-6



5050

ARTICULATORS average values

5050Plus is the most versatile articulator that complements Asa Dental laboratory instruments. 5050Plus is available as a standalone product or as an upgrade of 5050, with the addition of few accessories. Offering all the standard features of 5050, with a dedicated mounting plate the articulator becomes the ideal solution for all the techniques based on building the prosthetics on lower arches while a magnetic incisal rod safely prevents undesired alteration of the model during cast solidification. Simple, accurate and ergonomic, 5050Plus represents our best solution for dental technicians asking for a flexible and reliable average value, non-Arcon articulator.

FEATURES

- stable 60° operation for technician comfort
- ideal for class III patients
- compatible with any pressure polymerizers
- anti-rotation system for incisal rod
- total stability when working without incisal rod
- template with 4 elliptic references for lower arch models
- occlusal table with 4 elliptic references for upper arch models
- magnetic incisal rod for total stability
- bearing rod for 180° opening
- hinge rod with anti-shock protection system

TECHNICAL DATA

intercondylar distance	110 mm
condylar inclination fixed at	30°
Bennett angle	0 - 7°
incisal table inclination	0°
distance between mounting plates	87 mm
inclined contrast table	24°
opening	180°

EQUIPMENT

4 mounting plates	5000-1
2 locking knobs	5011-6



5050Plus

ARTICULATORS average values

lightweight anatomic articulator made of aluminum die-casting;
it can be used following the geometrical laws of medium values (Bonwill triangle);
fixing according to centric;
automatic return to the hinge axis with springs;
anti-shock hinge rod in case articulator falls accidentally;
bigger size lock screws for mounting plates;
anatomic back shoulders favour a practical and efficient holding of the articulator

FEATURES

- increased height and width
- more space when using removable stumps systems
- more space for installation of mobile prosthesis with high chewing or big base
- more space when using magnetic plates
- better back entrance
- variable internal working distance
- incisal guide rod and bearing rod for 180° opening are in stainless steel
- stainless steel hinge rod
- anti-shock protection system

TECHNICAL DATA

intercondylar distance	120 mm
condylar inclination fixed at	30°
Bennett angle fixed at	7°
incisal table inclination	10°
distance between mounting plates	90-110 mm
weight	700 gr
opening	180°

EQUIPMENT

2 spacers	5030-29
4 mounting plates	5000-1
2 locking knobs for spacer	5030-6
2 locking knobs for plates	5011-6

ACCESSORIES

face bow	5021
transfer table	5024
occlusal table	5030-2
fast caliper	5033



5030

ARTICULATORS average values

features 5032 - same features as mod. 5030 plus:
adjustable back rod by registration screw to work without incisal rod by keeping constant trajectories and inclinations during side and back/forward movements;
pure translation movement (key and instructions included)

FEATURES

- back rod on the upper side to unchanged back entrance and visibility and easy mechanisms regulation
- hinge rod with pure translation movement allowed

TECHNICAL DATA

intercondylar distance	120 mm
condylar inclination fixed at	30°
Bennett angle fixed at	7°
incisal table inclination	10°
distance between mounting plates	90-110 mm
weight	700 gr
opening	180°

EQUIPMENT

2 spacers	5030-29
2 magnetic mounting plates	5000-1M
2 locking knobs for spacer	5030-6
2 locking knobs for plates	5011-6

ACCESSORIES

face bow	5021
transfer table	5024
occlusal table	5030-2
fast caliper	5033



5032

ARTICULATORS
average values

EQUIPMENT

2 mounting plates	5000-1
2 locking knobs for plates	5011-6



5002

occlusor

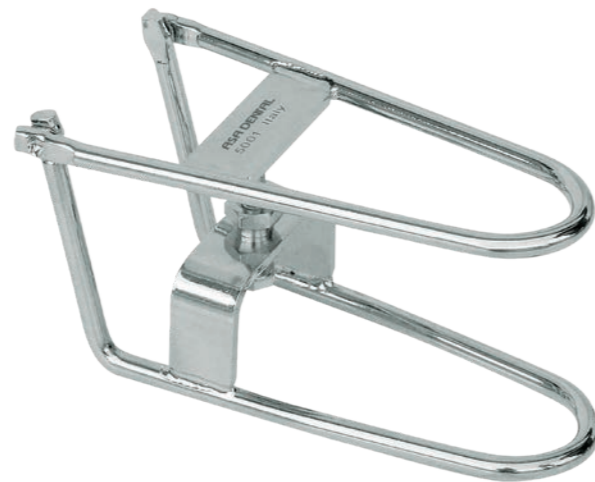

5001

spare parts

mounting plate
die-casting aluminum mounting plate
applicable to articulators

- 5050
- 5050Plus
- 5030
- 5032
- 5002
- 5000
- 5010
- 5011



5000-1

ARTICULATORS
spare parts



5000-26
magnet



5000-26

5000-30
magnet holder



5000-30

5000-1M
• die-casting aluminum teflon covered mounting plate
• magnet holder (5000-30)
• magnet (5000-26)

applicable to articulators
5050
5050Plus
5030
5032
5002
5000
5010
5011



5000-1M



5000-30



5000-26

5000-25
cast fastening washer
for die-casting aluminum
mounting plate
10 pcs / pack



5000-25

5030-29
spacer
applicable to articulators
5030
5032



5030-29

ARTICULATORS
spare parts

5050Plus

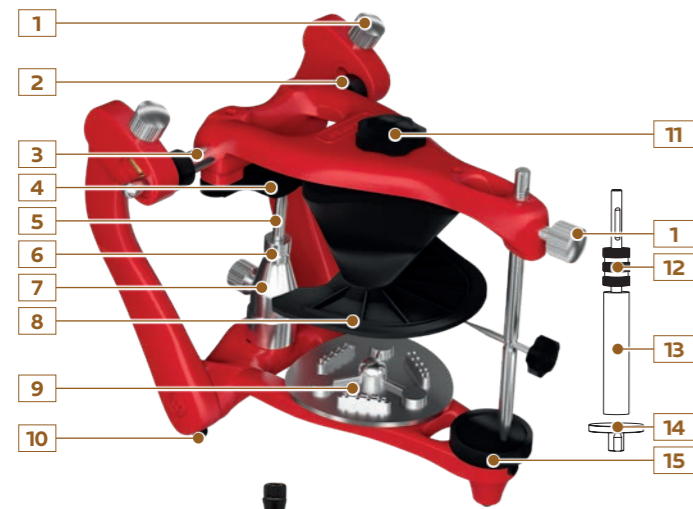

5050

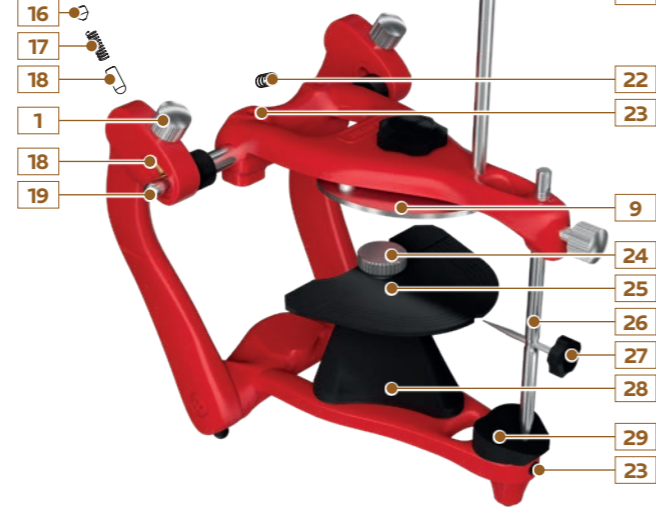

5030/5032

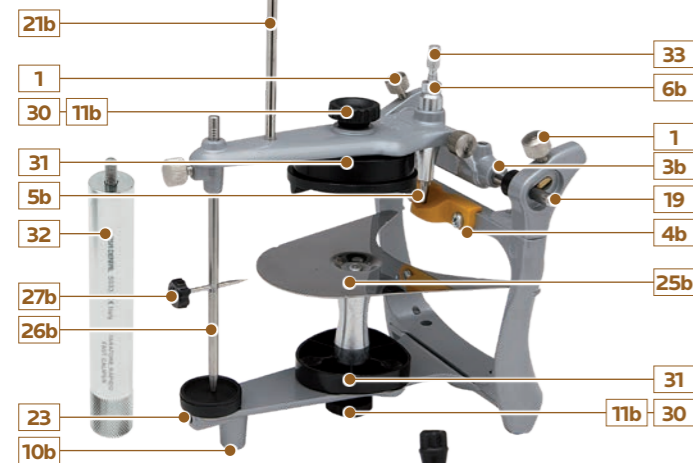

5000/5010

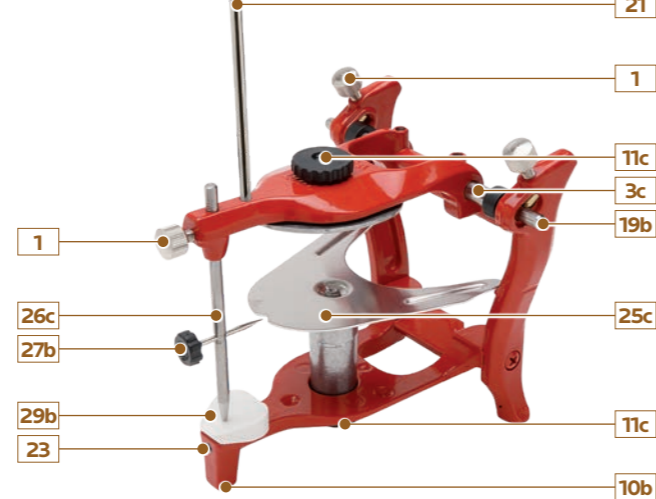

5011



ARTICULATORS
spare parts

		CURRENT MODELS					OLD MODELS		
		5050Plus	5050	5032	5030	5002	5011	5010	5000
1	metallic locking knob	5000-5	5000-5	5000-5	5000-5		5000-5	5000-5	5000-5
2	hinge rod washer	5011-18	5011-18	5011-18	5011-18		5011-18	5011-18	5011-18
3,3b,3c	hinge rod	5050-17	5050-17	5032-17	5032-17		5011-17	5011-17	5011-17
4,4b	inclined contrast table	5011-16		5032-16			5011-16		
5,5b,5c	back rod	5050-21		5032-21			5011-21		
6,6b	adjusting screw locknut	5011-23		5032-23			5011-23		
7,7b	back rod support	5050-20					5011-20		
8	template	5052	5052						
9	mounting plate	5000-1	5000-1	5000-1	5000-1	5000-1	5000-1	5000-1	5000-1
10,10b	rubber nubs (6 pcs/pack)	5050-24	5050-24	5000-24	5000-24		5000-24	5000-24	5000-24
11,11b,11c	locking knob	5050-6	5050-6	5011-6	5011-6	5000-6	5011-6	5000-6	5000-6
12	rod ferrule	5053-2							
13	magnetic rod	5053-1							
14	table for magnetic rod	5053-3							
12+13+14	magnetic rod kit	5053							
15	incisal guide table (0°)	5011-4		5011-4			5011-4		
16	adjusting screw - side shift	5000-7	5000-7	5000-7	5000-7		5000-7	5000-7	5000-7
17	side shift spring	5000-12	5000-12	5000-12	5000-12		5000-12	5000-12	5000-12
18	side shift cylinder	5000-13	5000-13	5000-13	5000-13		5000-13	5000-13	5000-13
19,19b	condylar guidance	5030-9	5030-9	5030-9	5030-9		5011-9	5011-9	5011-9
20	rubber cap	5011-11	5011-11	5011-11	5011-11		5011-11	5011-11	
21,21b	bearing rod	5010-10	5010-10	5030-10	5030-10		5010-10	5010-10	
22	hinge rod spring	5011-19	5011-19	5011-19	5011-19		5011-19	5011-19	5011-19
23	M5 screw - incisal table	5000-18	5000-18	5000-18	5000-18		5000-18	5000-18	5000-18
24	knurled knob for template and occlusal table	5050-4	5050-4						
25,25b,25c	occlusal table	5051	5051	5030-2	5030-2		5000-2	5000-2	5000-2
26,26b,26c	incisal guide rod	5050-3	5050-3	5030-3	5030-3		5000-3	5000-3	5000-3
27,27b	incisal pin	5050-8	5050-8	5000-8	5000-8		5000-8	5000-8	5000-8
28	support for occlusal table and template	5050-2	5050-2						
24+25+28	occlusal table assembly (5050-4 + 5051 + 5050-2)	5054	5054						
29,29b	incisal guide table (10°)		5000-4N		5000-4			5000-4	5000-4
30	locking knob for spacer			5030-6	5030-6				
31	spacer			5030-29	5030-29				
32	fast caliper			5033	5033				
33,33b	adjusting screw			5032-22			5011-22		
34	magnetic mounting plate - complete	5000-1M	5000-1M	5000-1M	5000-1M	5000-1M	5000-1M	5000-1M	5000-1M
35	magnet	5000-26	5000-26	5000-26	5000-26	5000-26	5000-26	5000-26	5000-26
36	cast fastening washers (10 pcs/pack)	5000-25	5000-25	5000-25	5000-25	5000-25	5000-25	5000-25	5000-25
37	magnet holder	5000-30	5000-30	5000-30	5000-30	5000-30	5000-30	5000-30	5000-30

Easy Bow

5020

complete set including facebow with three forks and transfer table for articulator

face bow	5021
fork holder block	5022
transfer table	5024
fork	5023-1
fork	5023-2
fork	5023-3

set applicable to articulators

5030

5032



5021



5022

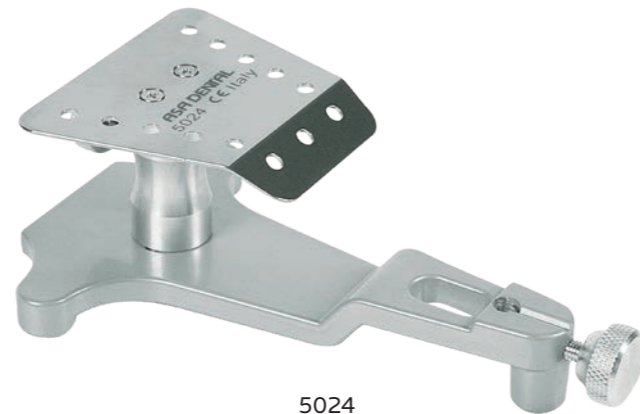

5024



5023-1



5023-2



5023-3

Easy Bow

instructions

1. insert the fork holder block into the arch
2. insert the fork into the patient's mouth
3. pull the ear olives outwards and insert the facebow



Easy Bow

instructions

4. regulate the Nasion position referring to the Frankfurt plan
5. connect the fork holder rod and lock all the knobs
6. face bow installed



7. pull the ear olives outwards and extract the face bow
8. loosen the knob and take away the fork holder block
9. place the fork holder block into the transfer table...

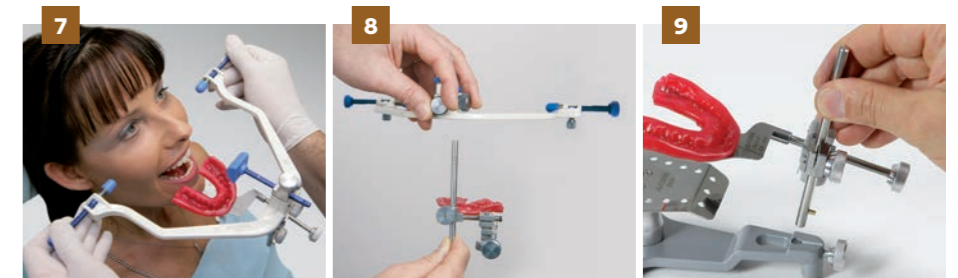

10. ...and fix the knob
11. if it is necessary regulate the little plate height; then remove the fork holder block
12. place the plaster on the plate and place again the fork holder block



13. after plaster hardening release the rod knob connected to the fork...
14. ...and extract the rod
15. release the knob and extract the fork holder block



16. place the table on the articulator...
17. ...inserting into the special lodges
18. fix the table on the articulator with the screw given with the articulator



19. place the model on the wax bite
20. put the plaster on the model...
21. ...end up the "articulator setting" as usual



Handle options

SINGLE END

● Alu80
(aluminum, hollow)
ø 8.0 mm



DOUBLE END

Asa60
(stainless steel)
ø 6.0 mm



Asa Light MV
(stainless steel, hollow)
ø 8.0 mm



● Alu80
(aluminum, hollow)
ø 8.0 mm



● Magic Color MC
(aluminum core and
non-slip plastic)
ø 8.0 / 10.5 mm



Wax and modelling carvers



1 Ward
1501-1
Asa60
MV1501-1
Asa Light MV



1S Ward
1501-1S
Asa60
MV1501-1S
Asa Light MV

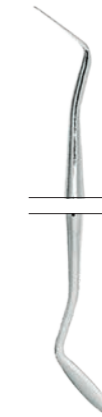

2 Ward
1501-2
Asa60
MV1501-2
Asa Light MV



2 USC
1503-2
Asa60

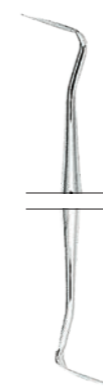

1/2 Hollenback
1500-02
Asa60
MV1500-02
Asa Light MV
MC1500-02

● Magic Color MC



3 Hollenback
1500-3
Asa60
MV1500-3
Asa Light MV



3S Hollenback
1500-3S
Asa60
MV1500-3S
Asa Light MV



1 Frahm
1502-1
Asa60
MV1502-1
Asa Light MV

Wax and modelling carvers

Wax and modelling carvers



Hylin
graded handle
in mm
5100-1

Hylin
5100

Hylin-Le Cron
5101

Hylin-Ceramica
5102

Hylin-ASA
5103

ASA
5104

Le Cron
5105

Le Cron
5106

Le Cron
5107

Le Cron
5108

Zahle
5109

Zahle
5110

Wax and modelling carvers

Wax and modelling carvers

sets of 5

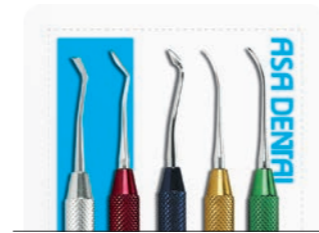

1 · 2 · 3 · 4 · 5
S5112
Asa60
1AL · 2AL · 3AL · 4AL · 5AL
S5112AL
Alu80



Zahle
5111



Gritman
5113



Beale
5114



Roach
5115



Vehe
5116



1 P.K. Thomas
5112-1
Asa60

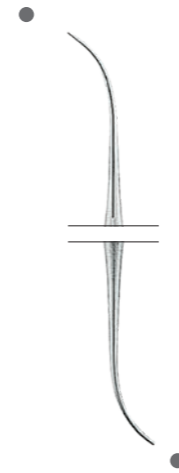

2 P.K. Thomas
5112-2
Asa60



3 P.K. Thomas
5112-3
Asa60

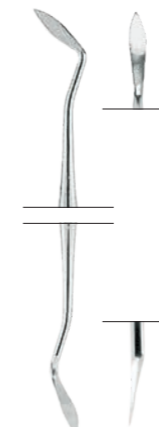

4 P.K. Thomas
5112-4
Asa60

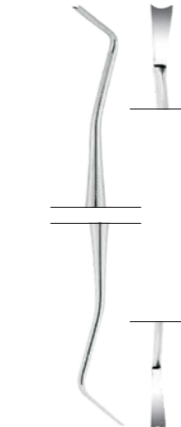

5 P.K. Thomas
5112-5
Asa60



1 P.K. Thomas
5112-1AL
Alu80



2 P.K. Thomas
5112-2AL
Alu80



3 P.K. Thomas
5112-3AL
Alu80



4 P.K. Thomas
5112-4AL
Alu80

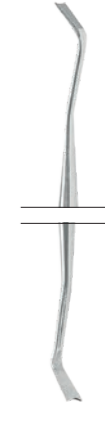

5 P.K. Thomas
5112-5AL
Alu80

Waxing instruments with replaceable tips

set of 3+3



1 · 2 · 3 · 1C · 2C · 3C
S5160



1
S5160-1C
● Alu80



2
S5160-2C
● Alu80



3
S5160-3C
● Alu80



1
5160-1



2
5160-2



3
5160-3

Laboratory tweezers



1
16.5 cm
6400-1



2
16 cm
6400-2



3 Meriam
16 cm
0601-3



2
12 cm
0645-2



3
11.5 cm
0645-3



3
15 cm
0635-3



4
18 cm
0635-4



6
26 cm
0635-6

Ceramic sculpturing brushes

set of 10



7000-6 · 7000-7 · 7000-8
 7001-3 · 7001-1 · 7001-0 · 7001-00
 7002-4 · 7002-6 · 7002-8
 S7000-10



7000-6 7000-7 7000-8 7001-3 7001-1 7001-0 7001-00 7002-4 7002-6 7002-8

Ceramic sculpturing instruments

sets of 3 handles + 6 blades



5150-1 · 5150-2 · 5150-3
 5156-1 · 5156-2 · 5156-3
 5150

5151-1 · 5151-2 · 5151-3
 5156-1 · 5156-2 · 5156-3
 5151



1 5150-1 ● Alu80
2 5150-2 ● Alu80
3 5150-3 ● Alu80
1 Greenstein 5151-1 ● Alu80
2 Greenstein 5151-2 ● Alu80
3 Greenstein 5151-3 ● Alu80

FLEXIBLE BLADES SUPERFLEXIBLE BLADES

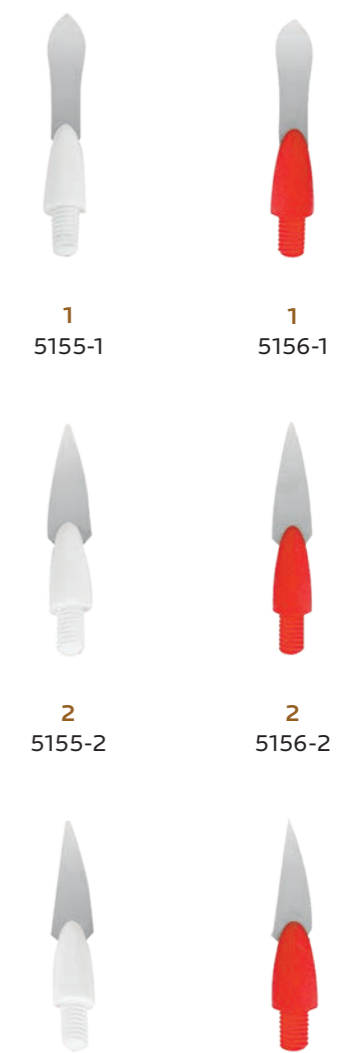

1 5155-1 **1** 5156-1
2 5155-2 **2** 5156-2
3 5155-3 **3** 5156-3

Wax knives

Plaster knives



WITH SMALL SPOON WITH SMALL SPOON

1 Fahnenstock
12.5 cm
5200-1

2 Fahnenstock
17 cm
5200-2

1 Lessmann
12.5 cm
5201-1

2 Lessmann
17 cm
5201-2

1
12.5 cm
5202-1

2
17 cm
5202-2



1
17 cm
5300-1

2
Gritman
17 cm
5300-2

3
16 cm
5300-3

4
16 cm
5300-4

the wooden handle may suffer color changes

the wooden handle may suffer color changes

Rigid spatulas for plaster, alginate and elastomers

alginate, plaster

alginate

elastomers

Flexible spatulas for plaster, alginate and elastomers

alginate, plaster

alginate

elastomers



1
18.5 cm
5400-1

2
18 cm
5400-2

8
20 cm
5400-8

9
22.5 cm
5400-9

3
18.5 cm
5400-3

5
21.5 cm
5400-5

6
20.5 cm
5400-6

7
19.5 cm
5400-7

4
19.5 cm
5400-4

the wooden handle may suffer color changes

the wooden handle may suffer color changes

Spatulas for plaster and alginate



19 cm 5401-B 19 cm 5401-C 19 cm 5401-F 19 cm 5401-G 19 cm 5401-R 19 cm 5401-V

Mixing bowls for plaster and alginate



Ø 160 mm Ø 140 mm Ø 120 mm Ø 100 mm
 2.2 L 5500-16 0.9 L 5500-14 0.5 L 5500-12 0.35 L 5500-10



Ø 160 mm Ø 140 mm Ø 120 mm Ø 100 mm
 2.2 L 5501-16 0.9 L 5501-14 0.5 L 5501-12 0.35 L 5501-10

Ortho/prothesis boxes

plastic box for removable retainers
 10 pcs / pack



Blue
 6900E-A



White
 6900E-B



Light blue
 6900E-C



Yellow
 6900E-G



Pink
 6900E-R



Green
 6900E-V

Scissors

for gold foils



1
straight
12 cm
0300-1



2
curved
12 cm
0300-2



wire scissor
one blade serrated

Universal
12 cm
5700

Crown scissors



1
straight
one blade serrated
10.5 cm
5600-1



2
curved
one blade serrated
10.5 cm
5600-2



1
straight
10.5 cm
5601-1



2
curved
10.5 cm
5601-2



Crown instruments

13 cm
0545-1

telescope crown pliers

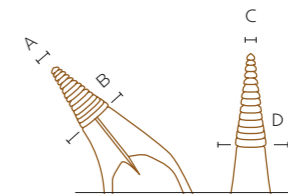

A	4.4 mm
B	5.0 mm

C	3.4 mm
D	3.8 mm

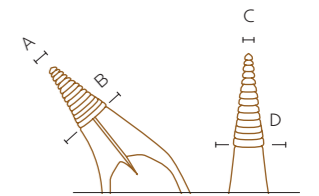

A	3.3 mm
B	4.0 mm

C	2.3 mm
D	3.0 mm



Bohm
14.5 cm
2500-2



Bohm
11.5 cm
2500-1

Calipers

spring calipers

measuring range: 0-10 mm



**Iwanson
for wax
2550-1**

measuring range: 0-10 mm



**Iwanson
for metal
2550-2**

measuring range: 0-15 mm



**18 cm
2557-1**

decimal calipers

measuring range:
0-200 mm / 0-7 in

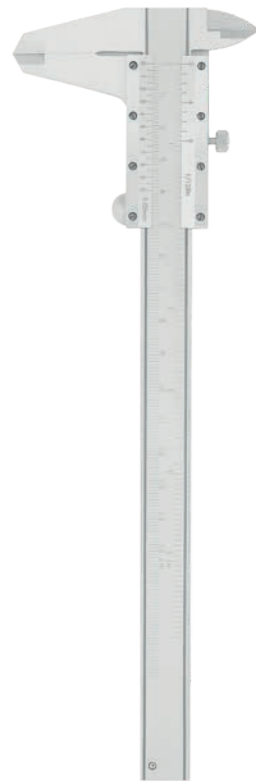

**aluminum
graded in mm and in
2556-1**

measuring range:
0-100 mm / 0-4 in



**Townley
graded in mm and in
2556-2**

measuring range:
0-100 mm / 0-4 in



**Jameson
graded in mm and in
2556-3**

measuring range:
0-100 mm



**Boley
14 cm
2555**

indicative measures

Plaster cutting pliers



**Asa Special Inox
19.5 cm
5900**

Mallets

riveting mallets



**22 cm
6000**



**22 cm
6001**

horn mallet



**20 cm
6002**

Crucible tongs



31 cm
6600-5



40 cm
6600-4



51 cm
6600-2

Saws and Blades

fret saw



25 cm
6200

fret saw blades
12 pcs / pack

130 mm x Ø 1.3 mm
for plaster
6201-1

130 x 0.52 x 0.26 mm
for metal
6201-2

saw for models



18 cm
6300

fret saw blades
12 pcs / pack

75 x 3 x 0.25 mm
6301-1

75 x 5 x 0.25 mm
6301-2

75 x 3 x 0.12 mm
6301-3

length x height x thickness

“Lab Set” for Laboratory

case with wax modelling and porcelain instruments



S6811-1

1	Greenstein ceramic sculpturing brush	5151-1
2	Greenstein ceramic sculpturing brush	5151-2
3	Greenstein ceramic sculpturing brush	5151-3
1	ceramic sculpturing blade	5156-1
2	ceramic sculpturing blade	5156-2
3	ceramic sculpturing blade	5156-3
1	P.K. Thomas modelling carver	5112-1AL
2	P.K. Thomas modelling carver	5112-2AL
3	P.K. Thomas modelling carver	5112-3AL
4	P.K. Thomas modelling carver	5112-4AL
5	P.K. Thomas modelling carver	5112-5AL
1	ceramic sculpturing instrument	S5160-1C
2	ceramic sculpturing instrument	S5160-2C
3	ceramic sculpturing instrument	S5160-3C
1	Lessman wax knife	5201-1
2	Lessman wax knife	5201-2
1	wax knife with spoon	5202-1
	porcelain sculpturing brushes	7000-7
	porcelain sculpturing brushes	7001-1
	porcelain sculpturing brushes	7002-8

case with wax modelling and porcelain instruments



S6811-2

	Hysin modelling carver	5100
	Hysin-Le Cron modelling carver	5101
	Hysin modelling carver	5105
	Zahle modelling carver	5111
1	P.K. Thomas modelling carver	5112-1
2	P.K. Thomas modelling carver	5112-2
3	P.K. Thomas modelling carver	5112-3
4	P.K. Thomas modelling carver	5112-4
5	P.K. Thomas modelling carver	5112-5
	Gritman modelling carver	5113
1	ceramic sculpturing instrument	S5160-1C
2	ceramic sculpturing instrument	S5160-2C
3	ceramic sculpturing instrument	S5160-3C
1	Fahnenstock wax knife	5200-1
2	Fahnenstock wax knife	5200-2
	caliper	2555

empty case for 17 instruments



8000

“Lab Set” for Laboratory

laboratory set with plastic case



S6810-1

2	laboratory tweezers	6400-2
	plaster cutting pliers	5900
	saw for models	6300
	mixing bowl - ø 120 mm	5500-12
2	crown scissors	5600-2
6	spatula for plaster and alginate	5400-6
2	Gritman plaster knife	5300-2
1	Fahnenstock wax knife	5200-1
2	Fahnenstock wax knife	5200-2
	wire forming pliers	5801-1
	Iwanson caliper	2550-2
	mallet	6001
	Hysin modelling carver	5100
	Hysin-Le Cron modelling carver	5101
	Hysin-Ceramica modelling carver	5102
	Hysin modelling carver	5105
	Le Cron modelling carver	5106
	Zahle modelling carver	5109
	Gritman modelling carver	5113
	Beale modelling carver	5114
1	P.K. Thomas modelling carver	5112-1
2	P.K. Thomas modelling carver	5112-2
3	P.K. Thomas modelling carver	5112-3
4	P.K. Thomas modelling carver	5112-4
5	P.K. Thomas modelling carver	5112-5

laboratory set with plastic case



S6810-2

2	laboratory tweezers	6400-2
	plaster cutting pliers	5900
	saw for models	6300
	mixing bowl - ø 120 mm	5500-12
2	crown scissors	5600-2
6	spatula for plaster and alginate	5400-6
2	Gritman plaster knife	5300-2
1	Fahnenstock wax knife	5200-1
2	Fahnenstock wax knife	5200-2
	Iwanson caliper	2550-2
	ceramic sculpturing instruments set	5150
	Hysin-Le Cron modelling carver	5101
	Le Cron modelling carver	5106
	Zahle modelling carver	5109
	Gritman modelling carver	5113
	Beale modelling carver	5114
1	P.K. Thomas modelling carver	5112-1
2	P.K. Thomas modelling carver	5112-2
3	P.K. Thomas modelling carver	5112-3
4	P.K. Thomas modelling carver	5112-4
5	P.K. Thomas modelling carver	5112-5

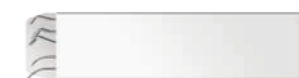

the wax and modelling carvers (5112-1-2-3-4-5) are included in the cases S6810-1 and S6810-2 into a carton package as per image

CODE INDEX

code	description	handle	page
0100-1	Extracting forceps		D4
0100-2	Extracting forceps		D4
0100-3	Extracting forceps		D4
0100-4	Extracting forceps		D4
0100-7	Extracting forceps		D4
0100-8	Extracting forceps		D4
0100-13	Extracting forceps		D5
0100-17	Extracting forceps		D5
0100-18	Extracting forceps		D5
0100-18A	Extracting forceps		D5
0100-19	Extracting forceps		D6
0100-20	Extracting forceps		D5
0100-21	Extracting forceps		D5
0100-22	Extracting forceps		D6
0100-22L	Extracting forceps · Roururier		D6
0100-22R	Extracting forceps · Roururier		D7
0100-23	Extracting forceps		D7
0100-24	Extracting forceps		D7
0100-29	Extracting forceps		D7
0100-29N	Extracting forceps		D7
0100-30	Extracting forceps		D8
0100-31	Extracting forceps		D8
0100-33	Extracting forceps		D8
0100-33A	Extracting forceps		D8
0100-33L	Extracting forceps		D8
0100-38A	Extracting forceps		D8
0100-41	Extracting forceps		D8
0100-43A	Extracting forceps		D9
0100-44	Extracting forceps		D9
0100-45	Extracting forceps		D9
0100-46	Extracting forceps		D9
0100-46L	Extracting forceps		D9
0100-48	Extracting forceps		D10
0100-49	Extracting forceps		D10
0100-51	Extracting forceps		D10
0100-51A	Extracting forceps		D10
0100-51L	Extracting forceps		D10
0100-51LX	Extracting forceps		D11
0100-52	Extracting forceps		D11
0100-54	Extracting forceps		D11
0100-55	Extracting forceps		D11
0100-56	Extracting forceps		D11
0100-59	Extracting forceps		D11
0100-59L	Extracting forceps		D11
0100-60	Extracting forceps		D12
0100-65L	Extracting forceps		D12
0100-65R	Extracting forceps		D12
0100-66L	Extracting forceps		D12
0100-66R	Extracting forceps		D13
0100-67	Extracting forceps		D13
0100-67/L	Extracting forceps		D13
0100-67/R	Extracting forceps		D13
0100-67A	Extracting forceps		D13
0100-68	Extracting forceps		D14

code	description	handle	page
0100-73	Extracting forceps		D14
0100-74	Extracting forceps		D14
0100-74M	Extracting forceps		D14
0100-74N	Extracting forceps		D14
0100-75	Extracting forceps		D15
0100-79	Extracting forceps		D15
0100-79A	Extracting forceps		D15
0100-79C	Extracting forceps		D15
0100-86/L	Extracting forceps · Roururier		D16
0100-86/R	Extracting forceps · Roururier		D16
0100-86C	Extracting forceps		D16
0100-86W	Extracting forceps · White		D17
0100-87	Extracting forceps		D17
0100-89	Extracting forceps		D18
0100-90	Extracting forceps		D18
0100-99	Extracting forceps		D18
0100-107	Extracting forceps		D19
0100-121	Extracting forceps · Ogden-Felsch		D19
0100-145	Extracting forceps		D19
0100-151/	Extracting forceps		D19
0100-166	Extracting forceps · Trotter		D17
0100-167	Extracting forceps · Trotter		D20
0100-168	Extracting forceps · Trotter		D19
0100-169	Extracting forceps · Trotter		D20
0100-346	Extracting forceps		D19
0100-349	Extracting forceps		D20
0100-359	Extracting forceps		D20
0101-1	Extracting forceps for roots · Witzel		D40
0101-2	Extracting forceps for roots · Witzel		D40
0102-1	Extracting forceps for root splinters and silver cones · Stieglitz		B16 D41
0102-2	Extracting forceps for root splinters and silver cones · Stieglitz		B16 D41
0103-10	Bone rongeurs · Luer		D42 E30
0103-20	Bone rongeurs · Friedman		D42
0103-25	Bone rongeurs · Mini Friedman		D42 E30 G30
0103-30	Bone rongeurs · Blumenthal		D43 E30
0103-31	Bone rongeurs · Blumenthal		D43 E30
0103-32	Bone rongeurs · Blumenthal		D43
0103-40	Bone rongeurs · Cleveland		D42
0103-45	Bone rongeurs · Cleveland-Gardner		D42
0103-50	Bone rongeurs · Mead		D43
0103-60	Bone/soft tissue nippers · Goldman-Fox		D44 E29 G30
0103-70	Bone rongeurs · Mini-Ruskin		D44
0103-71	Bone rongeurs · Beyer		D44
0103-78	Gum guillotine forceps · Tomati		G30
0104-1	Extracting forceps · Mead		D24

code	description	handle	page
0104-2	Extracting forceps · Mead		D24
0104-3	Extracting forceps · Mead		D24
0104-4	Extracting forceps · Mead		D24
0110-13S	Extracting forceps for children		D37
0110-22S	Extracting forceps for children		D37
0110-30S	Extracting forceps for children		D37
0110-33S	Extracting forceps for children		D37
0110-37	Extracting forceps for children		D37
0110-38	Extracting forceps for children		D38
0110-39	Extracting forceps for children		D38
0110-39L	Extracting forceps for children		D38
0110-39R	Extracting forceps for children		D38
0110-51S	Extracting forceps for children		D38
0112-1	Extracting forceps for children · Klein		D39
0112-2	Extracting forceps for children · Klein		D39
0112-3	Extracting forceps for children · Klein		D39
0112-4	Extracting forceps for children · Klein		D39
0112-5	Extracting forceps for children · Klein		D39
0112-6	Extracting forceps for children · Klein		D39
0112-7	Extracting forceps for children · Klein		D39
0120-5	Extracting forceps - American pattern · Physick		D25
0120-6	Extracting forceps - American pattern		D25
0120-10S	Extracting forceps - American pattern		D25
0120-16	Extracting forceps - American pattern		D25
0120-17	Extracting forceps - American pattern		D25
0120-18L	Extracting forceps - American pattern · Harris		D26
0120-18R	Extracting forceps - American pattern · Harris		D26
0120-23	Extracting forceps - American pattern		D26
0120-53L	Extracting forceps - American pattern		D26
0120-53R	Extracting forceps - American pattern		D26
0120-65	Extracting forceps - American pattern		D27
0120-69	Extracting forceps - American pattern · Tomes		D27
0120-88L	Extracting forceps - American pattern · Nevius		D27
0120-88R	Extracting forceps - American pattern · Nevius		D27
0120-101	Extracting forceps - American pattern · Hull		D27
0120-150	Extracting forceps - American pattern · Cryer		D28
0120-150S	Extracting forceps - American pattern · Cryer		D28
0120-151	Extracting forceps - American pattern · Cryer		D28

code	description	handle	page
0120-151S	Extracting forceps - American pattern · Cryer		D28
0120-222	Extracting forceps - American pattern		D28
0130-1	Extracting forceps · anatomic handle		D33
0130-2	Extracting forceps · anatomic handle		D33
0130-4	Extracting forceps · anatomic handle		D33
0130-7	Extracting forceps · anatomic handle		D33
0130-13	Extracting forceps · anatomic handle		D33
0130-17	Extracting forceps · anatomic handle		D34
0130-18	Extracting forceps · anatomic handle		D34
0130-21	Extracting forceps · anatomic handle		D34
0130-22	Extracting forceps · anatomic handle		D34
0130-33	Extracting forceps · anatomic handle		D34
0130-45	Extracting forceps · anatomic handle		D34
0130-51A	Extracting forceps · anatomic handle		D34
0130-67A	Extracting forceps · anatomic handle		D35
0130-74	Extracting forceps · anatomic handle		D35
0130-79	Extracting forceps · anatomic handle		D35
0130-86C	Extracting forceps · anatomic handle		D35
0130-89	Extracting forceps · anatomic handle		D36
0130-90	Extracting forceps · anatomic handle		D36
0130-145	Extracting forceps · anatomic handle		D36
0130-151/	Extracting forceps · anatomic handle		D36
0130-349	Extracting forceps · anatomic handle		D36
0130-359	Extracting forceps · anatomic handle		D36
0200-1	Root elevators · Bein		D47
0200-2	Root elevators · Bein		D47
0200-3	Root elevators · Bein		D47
0200-4	Root elevators · Bein		D47
0200-5	Root elevators · Bein		D47
0200-6	Root elevators · Bein		D47
0201-1	Root elevators · Flohr		D49
0201-2	Root elevators · Flohr		D49
0201-3	Root elevators · Flohr		D49
0202-320	Root elevators · Walter F. Barry		D61
0202-321	Root elevators · Walter F. Barry		D61
0202-322	Root elevators · Walter F. Barry		D61
0202-323	Root elevators · Walter F. Barry		D61
0202-350	Root elevators · Walter F. Barry		D61
0202-351	Root elevators · Walter F. Barry		D61
0202-370	Root elevators · Walter F. Barry		D61

code	description	handle	page	code	description	handle	page	code	description	handle	page	code	description	handle	page
0202-371	Root elevators · Walter F. Barry		D61	0221-A3C	Root elevators · Coupland		D56	0270-26	Root elevators · Cryer		D60	0305-1	Gum scissors · straight · Iris		C4
0203-1	Root elevators · Lecluse		D63	0222-190	Root elevators		D56	0270-44	Root elevators · Cryer		D60	0305-1TC	Gum scissors · straight · Iris		C4
0203-24	Root elevators · Pott		D63	0222-191	Root elevators		D56	0270-45	Root elevators · Cryer		D60	0305-2	Gum scissors · curved · Iris		C4
0203-25	Root elevators · Pott		D63	0223-15	Root elevators · Woodward		D56	0290-1	Root-tip picks · Heidbrink		D64	0305-2TC	Gum scissors · straight · Iris		C4
0204-11L	Root elevators · Winter		D62	0223-16	Root elevators · Woodward		D56	0290-2	Root-tip picks · Heidbrink		D64	0305-3	Gum scissors · curved · Iris		C5
0204-11R	Root elevators · Winter		D62	0228-31F	Root elevators · Friedman		D57	0290-3	Root-tip picks · Heidbrink		D64	0306-1	Gum scissors · curved, one blade serrated · Dean		C7
0204-12L	Root elevators · Winter		D62	0228-32F	Root elevators · Friedman		D57	0291-1	Root elevators · Heidbrink		D49	0306-1TC	Gum scissors · curved · Goldman-Fox		C4
0204-12R	Root elevators · Winter		D62	0229-1C	Root elevators · Coupland		D58	0291-1F	Root elevators · Mini Friedman		D57	0307-1	Gum scissors · curved, one blade serrated · La Grange		C7
0204-14L	Root elevators · Winter		D62	0229-1F	Root elevators · Friedman		D57	0291-2	Root elevators · Heidbrink		D49	0308-1	Gum scissors · straight · Quinby		C5
0204-14R	Root elevators · Winter		D62	0229-2C	Root elevators · Coupland		D58	0291-2F	Root elevators · Mini Friedman		D57	0308-2	Gum scissors · curved · Quinby		C5
0204-1L	Root elevators · Winter		D62	0229-2F	Root elevators · Friedman		D57	0291-3	Root elevators · Heidbrink		D49	0309-1	Gum scissors · straight · Kelly		C5
0204-1R	Root elevators · Winter		D62	0229-3C	Root elevators · Coupland		D58	0294-1	Root-tip picks · Warwick-James		D64	0309-1TC	Gum scissors · straight · Kelly		C5
0205-4	Root elevators · Schmeckebier-Apexo		D49	0230-11M	Root elevators · Mac Millan		D56	0294-2	Root-tip picks · Warwick-James		D64	0309-2	Gum scissors · curved · Kelly		C5
0205-4B	Root elevators · Schmeckebier-Apexo		D49	0230-12M	Root elevators · Mac Millan		D56	0294-3	Root-tip picks · Warwick-James		D64	0309-2TC	Gum scissors · curved · Kelly		C5
0205-5	Root elevators · Schmeckebier-Apexo		D49	0230-13M	Root elevators · Mac Millan		D56	0295-1	Syndesmotomes · Chompret		D65	0310-1	Gum scissors · angular, one blade serrated · Locklin		C6
0205-5B	Root elevators · Schmeckebier-Apexo		D49	0231-2	Root elevators · London Hospital		D46	0295-2	Syndesmotomes · Chompret		D65	0310-1TC	Gum scissors · angular · Locklin		C6
0206-71	Root elevators · Miller-Apexo		D52	0231-3	Root elevators · London Hospital		D46	0295-3	Syndesmotomes · Chompret		D65	0310-2	Gum scissors · angular, one blade serrated · Locklin		C6
0206-72	Root elevators · Miller-Apexo		D52	0232-1	Root elevators · Coleman		D46	0295-4	Syndesmotomes · Chompret		D65	0310-2TC	Gum scissors · angular · Locklin		C6
0206-73	Root elevators · Miller-Apexo		D52	0233-2	Root elevators		D46	0296-0	Syndesmotomes · tip		D66	0311-1	Gum scissors · straight, one blade serrated · Sullivan		C6
0206-74	Root elevators · Miller-Apexo		D52	0234-1	Root elevators · Hylin		D45	0296-1	Syndesmotomes · tip		D66	0311-2	Gum scissors · curved, one blade serrated · Sullivan		C6
0207-19	Root elevators		D52	0234-2	Root elevators · Hylin		D45	0296-2	Syndesmotomes · tip		D66	0312-1	Gum scissors · curved, sharp beaks · Westcott		C7
0207-20	Root elevators		D52	0234-3	Root elevators · Hylin		D45	0296-3	Syndesmotomes · tip		D66	0312-2	Gum scissors · curved, blunt beaks · Westcott		C7
0208-25	Root elevators · Seldin		D52	0234-4	Root elevators · Hylin		D45	0296-4	Syndesmotomes · tip		D66	0313-1	Gum scissors · curved, very thin beaks		C7
0208-35	Root elevators · Seldin		D52	0240-1	Root elevators · Bein		D48	0296-5	Syndesmotomes · tip		D66	0320-1	Gum scissors · suture · Spencer		C8
0208-34	Root elevators · Seldin		D52	0240-2	Root elevators · Bein		D48	0296-6	Syndesmotomes · tip		D66	0320-2	Gum scissors · suture · Spencer		C8
0208-34S	Root elevators · Seldin		D52	0240-3	Root elevators · Bein		D48	0296-7	Syndesmotomes · tip		D66	0321-1	Gum scissors · dissecting · straight · Metzenbaum		C8
0209-1L	Root elevators · Seldin		D53	0240-4	Root elevators · Bein		D48	0296-8	Syndesmotomes · tip		D66	0321-2	Gum scissors · dissecting · curved · Metzenbaum		C8
0209-1R	Root elevators · Seldin		D53	0240-5	Root elevators · Bein		D48	0296-9	Syndesmotomes · tip		D66	0322-1	Gum scissors · dissecting · straight · Metzenbaum-Delikat		C8
0209-4L	Root elevators · Seldin		D53	0240-6	Root elevators · Bein		D48	0296-11	Syndesmotomes · tip		D66	0322-2	Gum scissors · dissecting · curved · Metzenbaum-Delikat		C8
0209-4R	Root elevators · Seldin		D53	0241-2	Root elevators · Flohr		D58	0296-21	Syndesmotomes · tip		D66	0325-1	Gum scissors · suture · straight · Mayo		C8
0210-51	Root elevators · Curtis		D53	0241-3	Root elevators · Flohr		D58	0296-22	Syndesmotomes · tip		D67	0325-2	Gum scissors · suture · curved · Mayo		C8
0210-52	Root elevators · Curtis		D53	0242-1	Root elevators		D58	0296-23	Syndesmotomes · tip		D67	0328-1	Gum scissors · dissecting · straight · Stevens		C9
0211-11	Root elevators · Stout		D53	0242-2	Root elevators		D58	0296-24	Syndesmotomes · tip		D67	0328-2	Gum scissors · dissecting · curved · Stevens		C9
0211-11A	Root elevators · Stout		D53	0243-7	Root elevators · Cryer		D55	0296-25	Syndesmotomes · tip		D67	0329-1	Gum scissors · dissecting · rounded straight beaks · Stevens		C9
0213-12	Root elevators		D53	0243-8	Root elevators · Cryer		D55	0296-26	Syndesmotomes · tip		D67	0329-2	Gum scissors · dissecting · rounded curved beaks · Stevens		C9
0214-A	Root elevators · Cogswell		D54	0244-1	Root elevators · Kopp		D50	0296-27	Syndesmotomes · tip		D67	0330-1	Gum scissors · dissecting · straight · Stevens		C9
0215-301	Root elevators · Apexo		D54	0244-2	Root elevators · Kopp		D50	0296-28	Syndesmotomes · tip		D67	0330-2	Gum scissors · dissecting · curved · Stevens		C9
0215-302	Root elevators · Apexo		D54	0244-3	Root elevators · Kopp		D50	0296-29	Syndesmotomes · tip		D67	0335-1	Scalpel handles · orientable blade		C24
0215-303	Root elevators · Apexo		D54	0244-4	Root elevators · Kopp		D50	0296-M	Syndesmotomes · handle		D66				E9
0216-01W	Root elevators · Seldin		D54	0244-5	Root elevators · Kopp		D50	0297-1	Syndesmotomes instruments kit		D69				
0216-04W	Root elevators · Seldin		D54	0244-6	Root elevators · Kopp		D50	0300-1	Gum scissors · straight		C3				
0217-1	Root elevators · Heidbrink		D54	0250-1	Root elevators · Bein		D59				F45				
0217-2	Root elevators · Heidbrink		D54	0250-2	Root elevators · Bein		D59	0300-2	Gum scissors · curved		C3				
0217-40	Root elevators · Heidbrink		D54	0250-3	Root elevators · Bein		D59				K28				
0217-41	Root elevators · Heidbrink		D54	0250-4	Root elevators · Bein		D59	0301-1	Gum scissors · angular		C3				
0218-1	Root elevators		D51	0250-5	Root elevators · Bein		D59	0301-2	Gum scissors · angular, one blade serrated		C3				
0218-2	Root elevators		D51	0250-6	Root elevators · Bein		D59	0302-1	Gum scissors · curved · Neumann		C7				
0218-3	Root elevators		D51	0251-1	Root elevators · Flohr		D59	0303-1	Gum scissors · curved, very thin beaks · Noyes (Castroviejo)		C7				
0218-4	Root elevators		D51	0251-2	Root elevators · Flohr		D59	0304-1	Gum scissors · straight, one blade serrated · Goldman-Fox		C3				
0218-81A	Root elevators		D56	0251-3	Root elevators · Flohr		D59	0304-1TC	Gum scissors · straight · Goldman-Fox		C4				
0219-1	Root elevators		D51	0255-4	Root elevators · Schmeckebier-Apexo		D59	0304-2	Gum scissors · curved, one blade serrated · Goldman-Fox		C3				
0219-2	Root elevators		D51	0255-5	Root elevators · Schmeckebier-Apexo		D59	0304-2TC	Gum scissors · curved · Goldman-Fox		C4				
0220-25	Root elevators · Cryer		D55	0256-71	Root elevators · Miller-Apexo		D60	0304-3	Gum scissors · curved, one blade serrated · Goldman-Fox (special)		C4				
0220-26	Root elevators · Cryer		D55	0256-72	Root elevators · Miller-Apexo		D60								
0220-31	Root elevators · Cryer		D55	0259-4L	Root elevators · Seldin		D60								
0220-32	Root elevators · Cryer		D55	0259-4R	Root elevators · Seldin		D60								
0220-44	Root elevators · Cryer		D55	0265-301	Root elevators · Apexo		D60								
0220-45	Root elevators · Cryer		D55	0266-01W	Root elevators · Seldin		D60								
0221-A1C	Root elevators · Coupland		D56	0267-1	Root elevators · Heidbrink		D60								
0221-A2C	Root elevators · Coupland		D56	0267-2	Root elevators · Heidbrink		D60								
				0267-41	Root elevators · Heidbrink		D60								
				0270-25	Root elevators · Cryer		D60								

code	description	handle	page	code	description	handle	page	code	description	handle	page	code	description	handle	page
0350-3	Scalpel handles · double cutting edge		C26 E7	0417-15TC	Needle holders · Fine Swedish		C14	0480-4W	Syringes · cork screw tip, imperial thread (Withworth)		C29	0498-30B33	Osteotomes		E18
0350-3G	Scalpel handles		C26 E7	0418-15TC	Needle holders · Micro-Vascular		C14	0480-5	Syringes · self-aspirating, metric thread		C28	0498-30B4	Osteotomes		E18
0350-5	Scalpel handles		C26 E8	0419-16TC	Needle holders · scissors combined · Gillies		C14	0480-6	Syringes · self-aspirating, metric thread		C28	0498-30B5	Osteotomes		E18
0350-5A	Scalpel handles		C26 E8	0420-16	Needle holders · Mayo-Hegar		C12	0480-P1	Syringes · spare caps for syringe, metric thread		C29	0498-PF33	Osteotomes		E18
0350-7	Scalpel handles		C26 E7	0420-18	Needle holders · Mayo-Hegar		C12	0480-P2	Syringes · spare caps for syringe, imperial thread (Withworth)		C29	0498-PF4	Osteotomes		E18
0350-8	Scalpel handles		C26 E7	0421-18	Needle holders · light pattern · Toennis		C14	0481-7	Syringes · intra-ligamental, metric thread		C30	0498-PF5	Osteotomes		E18
0351-10	Scalpel blades		C26 E8	0422-19	Needle holders · Eiselberg-Mathieu		C15	0481-8	Syringes · intra-ligamental, metric thread		C30	0500-1	Hemostats · straight · Halstead-Mosquito		C21 F44
0351-11	Scalpel blades		C26 E8	0425-16TC	Needle holders · Mayo-Hegar		C12	0481-T1	Syringes · autoclavable plastic protection sleeve		C30	0500-2	Hemostats · curved · Halstead-Mosquito		C21
0351-12	Scalpel blades		C26 E8	0425-18TC	Needle holders · Mayo-Hegar		C12	0482-1	Syringes · syringes stand		C30	0501-1	Hemostats · straight · Micro-Mosquito		C22 F44
0351-12D	Scalpel blades · double cutting edge		C26 E8	0426-18TC	Needle holders · light pattern · Toennis		C14	0482-3W	Syringes · non self-aspirating, imperial thread (Withworth)		C28	0501-2	Hemostats · curved · Micro-Mosquito		C22
0351-15	Scalpel blades		C26 E8	0430-14	Needle holders · Mathieu		C16	0482-4W	Syringes · non self-aspirating, imperial thread (Withworth)		C28	0505-1	Hemostats · straight · Halstead-Mosquito 1x2		C21
0351-15C	Scalpel blades		C26 E8	0430-17	Needle holders · Mathieu		C16	0482-6W	Syringes · self-aspirating, imperial thread (Withworth)		C28	0505-2	Hemostats · curved · Halstead-Mosquito 1x2		C21
0352	Scalpel blade remover		C24 E9	0431-14	Needle holders · Mathieu		C16	0482-7W	Syringes · intra-ligamental, imperial thread (Withworth)		C30	0506-1	Hemostats · straight · Micro-Mosquito 1x2		C22
0360-4	Scalpel handles		C27	0432-14	Needle holders · scissors combined · Mathieu		C16	0483-1	Syringes · self-aspirating, metric thread		C28	0506-2	Hemostats · curved · Micro-Mosquito 1x2		C22
0361-20	Scalpel blades		C27	0432-14TC	Needle holders · Mathieu		C16	0483-2	Syringes · non self-aspirating, metric thread		C28	0507-1	Elastic forceps · straight · Halstead-Mosquito		H36
0361-21	Scalpel blades		C27	0432-17	Needle holders · smooth action · Lichtenberg		C15	0483-3	Syringes · non self-aspirating, metric thread		C28	0507-2	Elastic forceps · curved · Halstead-Mosquito		H36
0361-22	Scalpel blades		C27	0433-16	Needle holders · Arruga		C15	0490-1	Bone injector		E27	0510-1	Hemostats · straight · Kelly		C23 F44
0361-23	Scalpel blades		C27	0435-14TC	Needle holders · Mathieu		C17	0490-2	Bone injector		E27	0510-2	Hemostats · curved · Kelly		C23
0361-24	Scalpel blades		C27	0435-17TC	Needle holders · Mathieu		C17	0491-1	Bone thickness gauge		E31	0515-1	Hemostats · straight · Hartmann		C23
0365-1	Micro-blades		C27 E9	0436-14TC	Needle holders · Mathieu		C17	0491-2	Bone thickness gauge		E31	0515-2	Hemostats · curved · Hartmann		C23
0366-4	Micro-blades		C27 E9	0436-17TC	Needle holders · Mathieu		C17	0493-1	Aspirators		E33	0520-1	Hemostats · straight · Crile		C20
0366-7	Micro-blades		C27 E9	0437-17TC	Needle holders · Lichtenberg		E5	0493-2	Filter for aspirators		E33	0520-2	Hemostats · curved · Crile		C20
0371-10	Disposable scalpels		C25 E10	0438-16TC	Needle holders · Arruga		C15	0493-5	Aspirators		E33	0530-1	Hemostats · straight · Kocher 1x2		C20
0371-11	Disposable scalpels		C25 E10	0440-14	Needle holders · Castroviejo		C18	0494-1	Bone scraper · straight		E28	0530-2	Hemostats · curved · Kocher 1x2		C20
0371-12	Disposable scalpels		C25 E10	0440-18	Needle holders · Castroviejo		C19	0494-2	Bone scraper · curved		E28	0540-1	Hemostats · straight · Pean		C20
0371-15	Disposable scalpels		C25 E10	0441-14	Needle holders · with curved jaws · Castroviejo		C18	0494-2R	Bone scraper · straight		E28	0540-2	Hemostats · curved · Pean		C20
0400-14	Needle holders · scissors combined · Olsen-Hegar		C10	0441-18	Needle holders · with curved jaws · Castroviejo		C19	0495-1	Osteotomes		E19	0545-1	Crown instruments		K29
0401-12	Needle holders · Derf		C13	0442-13	Needle holders · Castroviejo		C19	0495-2	Osteotomes		E19	0550-1	Towel clamps · Backhaus		C31
0403-17	Needle holders · Adson		C10	0442-13L	Needle holders · smooth jaws · Castroviejo		C19	0495-3	Osteotomes		E19	0550-2	Towel clamps · Backhaus		C31
0404-14	Needle holders · Baumgartner		C11	0443-14	Needle holders · Castroviejo		C18	0495-4	Osteotomes		E19	0550-3	Towel clamps · Backhaus		C31
0405-14TC	Needle holders · Olsen-Hegar		C10	0444-12L	Needle holders · smooth jaws · Castroviejo-Barraquer		C18	0495-5	Osteotomes		E19	0555-1	Dressing forceps · straight · Gross-Maier		C32
0406-12TC	Needle holders · Derf		C13	0445-14TC	Needle holders · Castroviejo		E5	0495-6	Osteotomes		E19	0555-2	Dressing forceps · curved · Gross-Maier		C32
0407-13TC	Needle holders · smooth jaws · Halsey-Smooth		C13	0445-18TC	Needle holders · Castroviejo		C19	0496-1P	Osteotomes		E20	0557-1	Dressing forceps · straight · Gross-Maier		C32
0408-13TC	Needle holders · Halsey		C13	0446-14TC	Needle holders · Castroviejo		C18	0496-2P	Osteotomes		E20	0557-2	Dressing forceps · curved · Gross-Maier		C32
0409-14TC	Needle holders · Hegar-Baumgartner		C11	0446-18TC	Needle holders · Castroviejo		C19	0496-3P	Osteotomes		E20	0561-R	Tongue forceps		C33
0410-15	Needle holders · Crile-Wood		C10	0447-13TC	Needle holders · Castroviejo		C19	0496-4P	Osteotomes		E20	0565-1	Sterilizing forceps		I13
0414-16	Needle holders · scissors combined · Gillies		C14	0448-14TC	Needle holders · Castroviejo		C18	0497-1T	Osteotomes		E20	0565-2	Sterilizing forceps		I13
0415-15TC	Needle holders · Crile-Wood		C10	0450-18TC	Needle holders · Micro-Barraquer		C17	0497-2T	Osteotomes		E20	0560	Tongue forceps · Collin		C33
0416-15TC	Needle holders · Mini-Ryder		C13	0451-18TC	Needle holders · with curved jaws · Micro-Barraquer		C17	0497-3T	Osteotomes		E20	0561	Tongue forceps · Young		C33
0416-18TC	Needle holders · Mini-Ryder		C13	0480-1	Syringes · cork screw tip, metric thread		C29	0498-1B3	Osteotomes		E18	0600-17	Cotton and dressing pliers		B5
				0480-2	Syringes · cork screw tip, metric thread		C29	0498-1B33	Osteotomes		E18	0600-18	Cotton and dressing pliers		B5
				0480-3	Syringes · cork screw tip, metric thread		C29	0498-1B4	Osteotomes		E18	0600-18L	Cotton and dressing pliers · Locking		B3
				0480-4	Syringes · cork screw tip, metric thread		C29	0498-1B5	Osteotomes		E18	0600-19	Cotton and dressing pliers		B5
								0498-2C3	Osteotomes		E18	0600-2	Cotton and dressing pliers · London-College		B4
								0498-2C4	Osteotomes		E18	0600-3	Cotton and dressing pliers		B5
								0498-2C5	Osteotomes		E18	0600-4	Cotton and dressing pliers · Perry		B4
								0498-30B3	Osteotomes		E18	0601-1	Cotton and dressing pliers · Flagg		B4

code	description	handle	page	code	description	handle	page	code	description	handle	page	code	description	handle	page
0601-2	Cotton and dressing pliers · London-College		B4	0700-11	Single-ended Explorers	Asa60	B6	0705L-23GF	Combination Explorers - Probes · Goldman-Fox	Asa60	B10	1020-2	Amalgam carriers · 45°		F21
0601-3	Cotton and dressing pliers · Meriam		B4 K19	0700-12	Single-ended Explorers	Asa60	B6	0705L-23UM	Combination Explorers - Probes · University of Michigan	Asa60	B10	1020-2P	Amalgam carriers		F21
0601-4	Cotton and dressing pliers · Perry		B4	0700-16	Single-ended Explorers	Asa60	B6	0705L-23W	Combination Explorers - Probes · Williams	Asa60	B10	1020-3	Amalgam carriers · 90°		F21
0601-5	Cotton and dressing pliers · Perry		B4	0700-17	Single-ended Explorers	Asa60	B6	0705L-3GF	Root-canal Explorers · Goldman-Fox	Asa60	B10	1021-1	Amalgam carriers · straight, autoclavable plastic		F21
0602-1	Cotton and dressing pliers		B3	0700-17A	Single-ended Explorers	Asa60	B6	0706L-2311	Combination Explorers - Probes	Asa60	B10	1021-1P	Amalgam carriers · straight spare tip, autoclavable plastic		F21
0602-2	Cotton and dressing pliers		B3	0700-2	Single-ended Explorers	Asa60	B6	0706L-2312	Combination Explorers - Probes	Asa60	B11	1021-2	Amalgam carriers · 45°, autoclavable plastic		F21
0620-1	Tissue pliers · Adson		C38 E36	0700-23	Single-ended Explorers	Asa60	B6	0707L-GFW	Combination Explorers - Probes · Goldman-Fox Williams	Asa60	B11	1021-2P	Amalgam carriers · 45° spare tip, autoclavable plastic		F21
0621-1	Tissue pliers · Adson 1x2		C38 E36	0700-3	Single-ended Explorers	Asa60	B6	0708-1N	Double ended Explorers · Nabers	Asa60	B11	1021-3	Amalgam carriers · 90°, autoclavable plastic		F21
0622-1	Tissue pliers · Micro-Adson 1x2		C38	0700-3A	Single-ended Explorers	Asa60	B6	0708-2N	Double ended Explorers · Nabers	Asa60	B11	1021-3P	Amalgam carriers · 90° spare tip, autoclavable plastic		F21
0622-2	Tissue pliers · Micro-Adson 1x2		C39	0700-6	Single-ended Explorers	Asa60	B6	0708L-2N	Double ended Explorers · Nabers	Asa60	B11	1030-1	Amalgam wells		F20
0623-1	Tissue pliers		C39	0700-8	Single-ended Explorers	Asa60	B6	0709-2	Double ended Explorers	Asa60	B8	1030-2	Amalgam wells		F20
0624-1	Tissue pliers · Micro-Adson		C39	0700-9	Single-ended Explorers	Asa60	B6	0709-2A	Double ended Explorers	Asa60	B8	1030-3	Amalgam wells		F20
0624-2	Tissue pliers · Micro-Adson		C39	0701-10	Single-ended Explorers	Asa60M	B6	0709-3	Double ended Explorers	Asa60	B9	1030-4	Bone well		E32
0625-1	Suture pliers		C40	0701-11	Single-ended Explorers	Asa60M	B6	0710-6D1	Root-canal Explorers	Asa60	B9	1100-1	Separating spatulas · Heidemann	Octagonal	F23
0626-1	Tissue pliers · non traumatic · Adson Brown		C41	0701-12	Single-ended Explorers	Asa60M	B6	0710-6D2	Root-canal Explorers	Asa60	B9	1100-2	Separating spatulas · Heidemann	Octagonal	F23
0630-1	Tissue pliers · Semken-Taylor		C41 E36	0701-16	Single-ended Explorers	Asa60M	B6	0710-6D3	Root-canal Explorers	Asa60	B9	1100-3	Separating spatulas · Heidemann	Octagonal	F23
0630-2	Tissue pliers · Semken-Taylor		C41 E36	0701-17	Single-ended Explorers	Asa60M	B6	0800	Ruler for endodontic		B15	1101-1	Separating spatulas · Heidemann	Asa60	F23
0631-1	Tissue pliers · Semken-Taylor 1x2		C41	0701-17A	Single-ended Explorers	Asa60M	B6	0800-1	Root-canal Spreaders	Asa60	B12	1101-2	Separating spatulas · Heidemann	Asa60	F23
0631-2	Tissue pliers · Semken-Taylor 1x2		C41	0701-2	Single-ended Explorers	Asa60M	B6	0800-2	Root-canal Spreaders	Asa60	B12	1101-3	Separating spatulas · Heidemann	Asa60	F23
0635-1	Tissue pliers		C43	0701-23	Single-ended Explorers	Asa60M	B6	0800-3	Root-canal Spreaders	Asa60	B12	1102-1	Separating spatulas · Heidemann	Asa60	F24
0635-2	Tissue pliers		C43	0701-3	Single-ended Explorers	Asa60M	B6	0800-4	Root-canal Spreaders	Asa60	B12	1102-2	Separating spatulas · Heidemann	Asa60	F24
0635-3	Tissue pliers		C43 K19	0701-3A	Single-ended Explorers	Asa60M	B6	0800-5	Root-canal Spreaders	Asa60	B12	1102-3	Separating spatulas · Heidemann	Asa60	F24
0635-4	Tissue pliers		C43 K19	0701-5	Single-ended Explorers	Asa60M	B6	0800-6	Root-canal Spreaders	Asa60	B12	1102T-1	Separating spatulas · Titanium nitride coating · Heidemann	Asa60	F24
0635-5	Tissue pliers		C43	0701-6	Single-ended Explorers	Asa60M	B6	0801-1	Root-canal Pluggers · Luks	Asa60	B13	1102T-2	Separating spatulas · Titanium nitride coating · Heidemann	Asa60	F24
0635-6	Laboratory tweezers		K19	0701-8	Single-ended Explorers	Asa60M	B6	0801-2	Root-canal Pluggers · Luks	Asa60	B13	1102T-3	Separating spatulas · Titanium nitride coating · Heidemann	Asa60	F24
0645-1	Tissue pliers		C42	0701-9	Single-ended Explorers	Asa60M	B6	0801-3	Root-canal Pluggers · Luks	Asa60	B13	1200-1	Filling instruments - amalgam	Asa60	F26
0645-2	Tissue pliers		C42 K19	0702-C	Periodontal pocket Probes	Asa35	G3	0801-4	Root-canal Pluggers · Luks	Asa60	B13	1200-2	Filling instruments - amalgam	Asa60	F26
0645-3	Tissue pliers		C42 K19	0702L-11	Periodontal pocket Probes	Asa60	E32 G3	0802L-1	Vertical condensers	Asa60	B15	1200-3	Filling instruments - amalgam	Asa60	F26
0645-4	Tissue pliers		C42	0702L-12	Periodontal pocket Probes	Asa60	E32 G3	0802L-2	Vertical condensers	Asa60	B15	1200-4	Filling instruments - amalgam	Asa60	F26
0645-5	Tissue pliers		C42	0702L-12S	Periodontal pocket Probes	Asa60	E32 G3	0802L-3	Vertical condensers	Asa60	B15	1200-5	Filling instruments - amalgam	Asa60	F26
0650-1	Periodontal pocket markers · Goldman-Fox (Crane-Kaplan)		B3 E35 G31	0702L-15	Periodontal pocket Probes	Asa60	G3	0802L-4	Vertical condensers	Asa60	B15	1200T-1	Filling instruments - amalgam · Titanium nitride coating	Asa60	F25
0650-2	Periodontal pocket markers · Goldman-Fox (Crane-Kaplan)		B3 E35 G31	0703L-1	Periodontal pocket Probes · Williams	Asa60	G3	0870-1	Pliers for removing broken broaches		B16	1200T-2	Filling instruments - amalgam · Titanium nitride coating	Asa60	F25
0660-1	Membrane holding tweezers		E37	0703L-2	Periodontal pocket Probes · Merrit A	Asa60	G3	0870-2	Pliers for removing broken broaches		B16	1200T-3	Filling instruments - amalgam · Titanium nitride coating	Asa60	F25
0660-2	Membrane holding tweezers · with delicate ring tips		E37	0703L-3	Periodontal pocket Probes · Merrit B	Asa60	G3	0900-1	Cement spatulas		F22	1201-1	Filling instruments - amalgam	Asa60	F26
0661-1	Implant holding tweezers		E37	0703L-4	Periodontal pocket Probes · Goldman-Fox	Asa60	G3	0900-2	Cement spatulas		F22	1201-1L	Filling instruments - amalgam · Asa Com 9/9B	Asa60	F26 F49
0661-2	Implant holding tweezers		E37	0703L-5	Periodontal pocket Probes · University of Michigan	Asa60	G3	0903-0	Cement spatulas		F22	1201-2	Filling instruments - amalgam	Asa60	F26
0661-3	Implant holding tweezers		E37	0703L-6	Periodontal pocket Probes	Asa60	G3	0903-00	Cement spatulas		F22	1201-2L	Filling instruments - amalgam · Asa Com 10/10B	Asa60	F26 F49
0670	Articulating paper forceps · Miller		F42	0704-11/12AF	Double ended Explorers	Asa60	B8	0903-1	Cement spatulas		F22	1201-3	Filling instruments - amalgam	Asa60	F26
0671	Articulating paper forceps		F42	0704-16D1	Double ended Explorers	Asa60	B8	0903-2	Cement spatulas		F22	1201-3L	Filling instruments - amalgam	Asa60	F26
0680	Towel clamps · Schaedle		C31	0704-16D2	Double ended Explorers · Asa Com 2/2B	Asa60	B8 F48	0903-3	Cement spatulas		F22	1202-1	Filling instruments - amalgam	Asa60	F27
0681	Towel clamps · Jones		C31	0704-23D1	Double ended Explorers	Asa60	B8	0903-4	Cement spatulas		F22	1202-2	Filling instruments - amalgam	Asa60	F27
0690	Ultralight Mirrors		B21	0704-23D2	Double ended Explorers	Asa60	B8	0999-1	Glass plate		F22	1202-2L	Filling instruments - amalgam	Asa60	F27
0690-G	Ultralight Mirrors		B21	0704-6D9	Double ended Explorers	Asa60	B8	1009-1	Amalgam carriers · straight for retrograds		F21	1202-3	Filling instruments - amalgam	Asa60	F27
0690-L	Ultralight Mirrors		B21	0704-UT1	Double ended Explorers · Cattoni	Asa60	B8	1009-2	Amalgam carriers · curved for retrograds		F21	1202-3L	Filling instruments - amalgam	Asa60	F27
0690-M	Ultralight Mirrors		B21	0705L-16GF	Combination Explorers - Probes · Goldman-Fox	Asa60	B10	1009-3	Amalgam carriers · straight for retrograds		F21	1202-4	Filling instruments - amalgam	Asa60	F27
0690-T	Ultralight Mirrors		B21	0705L-16W	Combination Explorers - Probes · Williams	Asa60	B10	1009-4	Amalgam carriers · curved for retrograds		F21	1202-4L	Filling instruments - amalgam	Asa60	F27
0691	Ultralight Retractors		B21	0705L-17GF	Combination Explorers - Probes · Goldman-Fox	Asa60	B10	1011-1	Amalgam carriers · small		F20	1202T-1	Filling instruments - amalgam · Titanium nitride coating	Asa60	F25
0700-10	Single-ended Explorers	Asa60	B6	0705L-17UM	Combination Explorers - Probes · University of Michigan	Asa60	B10	1011-2	Amalgam carriers · medium		F20				
				0705L-17W	Combination Explorers - Probes · Williams	Asa60	B11	1011-3	Amalgam carriers · large		F20				
								1011-4	Amalgam carriers · jumbo		F20				
								1015-1	Amalgam carriers · medium/small		F20				
								1015-2	Amalgam carriers · medium/large		F20				
								1015-3	Amalgam carriers · medium/jumbo		F20				
								1020-1	Amalgam carriers · straight		F21				

code	description	handle	page	code	description	handle	page	code	description	handle	page	code	description	handle	page
1202T-2	Filling instruments - amalgam · Titanium nitride coating	Asa60	F25	1214-A	Filling instruments - Burnishers	Asa60	F31	1500-02	Amalgam/wax carvers · Hollenback	Asa60	F36	1706-19	Excavators - spoons	Asa60	F14
1203-1	Filling instruments - amalgam · Asa Com 3/3B	Asa60	F27	1215-18	Filling instruments - Burnishers · Ball	Asa60	F31	K13				1706-19W	Excavators - oval spoons	Asa60	F15
1203-2	Filling instruments - amalgam	Asa60	F27	1215-27S	Filling instruments - Burnishers · Ball	Asa60	F31	1500-3	Amalgam/wax carvers · Hollenback	Asa60	F36	1707-39	Excavators - spoons	Asa60	F14
1203-3	Filling instruments - amalgam · Asa Com 4/4B	Asa60	F27	1215-29	Filling instruments - Burnishers · Ball	Asa60	F31	K13				1709-31L	Root-canal Excavators	Asa60	B15
1204-1	Filling instruments - Burnishers · Westcott	Asa60	F31	1215-W3	Filling instruments - Burnishers · Ball	Asa60	F31	1500-3S	Amalgam/wax carvers · Hollenback	Asa60	F36	1709-32L	Root-canal Excavators	Asa60	B15
1204-2	Filling instruments - Burnishers · Westcott	Asa60	F31	1216-1	Filling instruments - plastic · Woodson	Asa60	F35	K13				1709-33L	Root-canal Excavators	Asa60	B15
1204T-1	Filling instruments - amalgam · Titanium nitride coating · Westcott	Asa60	F25	1216-2	Filling instruments - plastic · Woodson	Asa60	F35	1501-1	Amalgam/wax carvers · Ward	Asa60	F36	F14			
1205-1	Filling instruments - amalgam · Ward	Asa60	F28	1216-3	Filling instruments - plastic · Woodson	Asa60	F35	K13				1710-14	Excavators · SS. White	Asa60	F16
1205-2	Filling instruments - amalgam · Ward	Asa60	F28	1217-11	Filling instruments - plastic	Asa60	F35	1501-1S	Amalgam/wax carvers · Ward	Asa60	F36	1710-17	Excavators · SS. White	Asa60	F16
1206-1	Filling instruments - plastic	Asa60	F34	1218-6	Filling instruments - plastic	Asa60	F35	K13				1710-18	Excavators · SS. White	Asa60	F16
1206-2	Filling instruments - plastic	Asa60	F34	1219-179	Filling instruments - plastic · Asa Com 5/5B	Asa60	F35	1501-2	Amalgam/wax carvers · Ward	Asa60	F36	1710-19	Excavators · SS. White	Asa60	F16
1207-1	Filling instruments - plastic	Asa60	F34	1220-1	Composite instruments · Felt	Alu60	F32	K13				1710-20	Excavators · SS. White	Asa60	F16
1207-2	Filling instruments - plastic	Asa60	F34	1220-2	Composite instruments · Felt	Alu60	F32	1502-1	Amalgam/wax carvers · Frahm	Asa60	F37	1710-5	Excavators · SS. White	Asa60	F16
1208-1	Filling instruments - plastic	Asa60	F34	1220-3	Composite instruments · Felt	Alu60	F32	K13				1711-1	Excavators · Darby-Perry	Asa60	F17
1208-2	Filling instruments - plastic	Asa60	F34	1220-4	Composite instruments · Felt	Alu60	F32	1503-2	Amalgam/wax carvers · USC	Asa60	F37	1711-11	Excavators · Darby-Perry	Asa60	F17
1208-3	Filling instruments - plastic	Asa60	F34	1220-5	Composite instruments · Felt	Alu60	F32	K13				1711-12	Excavators · Darby-Perry	Asa60	F17
1208T-1	Filling instruments - plastic · Titanium nitride coating	Asa60	F33	1220-6	Composite instruments · Felt	Alu60	F32	1504-1	Amalgam carvers · Interproximal	Asa60	F37	1711-2	Excavators · Darby-Perry	Asa60	F17
1208T-2	Filling instruments - plastic · Titanium nitride coating	Asa60	F33	1220-B2	Filling instruments - Burnishers · Asa Com 8/8B · New York Univeristy	Asa60	F31	1504-2	Amalgam carvers · Interproximal Off-angle · Asa Com 6/6B	Asa60	F48	1711-21	Excavators · Darby-Perry	Asa60	F17
1208T-3	Filling instruments - plastic · Titanium nitride coating	Asa60	F33	1221-31	Filling instruments - Burnishers	Asa60	F31	1505-3	Amalgam carvers	Asa60	F37	1711-22	Excavators · Darby-Perry	Asa60	F17
1209-1	Filling instruments - plastic	Asa60	F34	1300	Placement instruments	Asa35	F39	1506-104	Amalgam carvers	Asa60	F37	1711-243	Excavators - ASH	Asa60	F15
1209-2	Filling instruments - plastic	Asa60	F34	1301	Placement instruments	Asa60	F39	1507-8	Amalgam carvers · Wiland	Asa60	F37	1711-31	Excavators · Darby-Perry	Asa60	F17
1209-3	Filling instruments - plastic	Asa60	F34	1302	Placement instruments	Asa60	F39	1600-1	Amalgam carvers · cleoid-discoid	Asa60	F38	1711-32	Excavators · Darby-Perry	Asa60	F17
1209T-2	Filling instruments - plastic · Titanium nitride coating	Asa60	F33	1303	Medication instruments · Orban Loop	Octagonal	F39	1600-2	Amalgam carvers · cleoid-discoid	Asa60	F38	1711-41	Excavators · Darby-Perry	Asa60	F17
1210-1	Composite instruments · Asa Com 14/14B	Asa60	F35	1310-1	Instruments for retractor wire	Asa60	F38	1600-3	Amalgam carvers · cleoid-discoid	Asa60	F38	1711-42	Excavators · Darby-Perry	Asa60	F17
1210-2	Filling instruments - plastic	Asa60	F35	1310-2	Instruments for retractor wire	Asa60	F38	1600-4	Amalgam carvers · cleoid-discoid	Asa60	F38	1711-G2	Excavators - ASH	Asa60	F15
1210-3	Filling instruments - plastic · Asa Com 15/15B	Asa60	F35	1350-1	Ligature Instruments · band seating and removing instrument		H35	1601-1	Cavity preparation instruments - margin trimmers · distal · Black/26	Asa60	F18	1800-1	Bone chisels and gouges · Ochsenbein		G27
1210T-2	Filling instruments - plastic · Titanium nitride coating	Asa60	F33	1350-2	Ligature Instruments · band seating and removing instrument		H35	1601-2	Cavity preparation instruments - margin trimmers · mesial · Black/27	Asa60	F19	1800-2	Bone chisels and gouges · Ochsenbein		G27
1211-0T	Filling instruments - amalgam · Tanner	Asa60	F28	1351-1	Ligature Instruments · band seating and removing instrument		H35	1601-3	Cavity preparation instruments - margin trimmers · distal · Black/28	Asa60	F19	1801-1	Chisels · TG	Asa60	G26
1211-1T	Filling instruments - amalgam · Tanner	Asa60	F28	1352-1	Elastic instruments		H35	1601-4	Cavity preparation instruments - margin trimmers · mesial · Black/29	Asa60	F19	1801-2	Chisels · TG	Asa60	G26
1211-2T	Filling instruments - amalgam · Tanner	Asa60	F28	1355-1	Gauze packers · ligature and archwire tucker · Luniatschek	Octagonal	H36	1602-1	Cavity preparation instruments - margin trimmers · mesial · Black/29	Asa60	F19	1801-D	Chisels · TG	Asa60	G26
1211-3T	Filling instruments - amalgam · Tanner	Asa60	F28	1355-2	Gauze packers · ligature and archwire tucker · Luniatschek	Octagonal	F39	1602-2	Cavity preparation instruments - margin trimmers · mesial · Black/79-80	Asa60	F19	1802-3	Chisels · Ochsenbein	Asa60	G26
1212-01	Filling instruments - amalgam · Marquette	Asa60	F28	1400-1	Filling instruments - amalgam · Markley	Asa60	F29	1603-1	Cavity preparation instruments - hatchets · Black/53-54	Asa60	F18	1802-4	Chisels · Ochsenbein	Asa60	G26
1213-H1	Filling instruments - amalgam · Hollenback	Asa60	F28	1400-2	Filling instruments - amalgam · Markley	Asa60	F29	1603-2	Cavity preparation instruments - hatchets · Black/51-52	Asa60	F18	1803-1	Gingivectomy knives · Kirkland	Asa60	G24
1213-H2	Filling instruments - amalgam · Hollenback	Asa60	F28	1400-3	Filling instruments - amalgam · Markley	Asa60	F29	1604-02	Cavity preparation instruments - chisels · Wedelstaet	Asa60	F18	1803-2	Gingivectomy knives · Kirkland	Asa60	G24
1213-H3	Filling instruments - amalgam · Asa Com 12/12B · Hollenback	Asa60	F28	1400-4	Filling instruments - amalgam · Markley	Asa60	F29	1604-04	Cavity preparation instruments - chisels · Wedelstaet	Asa60	F18	1803-D	Gingivectomy knives · Kirkland	Asa60	G24
1213-H4	Filling instruments - amalgam · Hollenback	Asa60	F28	1400-5	Filling instruments - amalgam · Markley	Asa60	F29	1604-06	Cavity preparation instruments - chisels · Wedelstaet	Asa60	F18	1804-1	Gingivectomy knives · Orban	Asa60	G24
1214-2	Filling instruments - Burnishers · Ladmore	Asa60	F31	1401-0	Filling instruments - amalgam · Foc	Asa60	F30	1700-0	Excavators - spoons	Asa60	F13	1804-2	Gingivectomy knives · Orban	Asa60	G24
1214-3	Filling instruments - Burnishers · Ladmore	Asa60	F31	1401-0S	Filling instruments - amalgam · Foc	Asa60	F30	1700-1	Excavators - spoons	Asa60	F13	1804-D	Gingivectomy knives · Orban	Asa60	G24
				1401-1	Filling instruments - amalgam · Asa Com 11/11B · Foc	Asa60	F49	1700-2	Excavators - spoons	Asa60	F13	1805-02	Curettes and Scalers · Langer	Asa60	G5
				1401-1S	Filling instruments - amalgam · Foc	Asa60	F30	1700-3	Excavators - spoons	Asa60	F13	1805-04	Curettes and Scalers · Langer	Asa60	G5
				1401-2	Filling instruments - amalgam · Foc	Asa60	F30	1700-4	Excavators - spoons	Asa60	F13	1806-02	Curettes and Scalers	Asa60	G4
				1401-2S	Filling instruments - amalgam · Foc	Asa60	F30	1701-1	Excavators - spoons	Asa60	F13	1806-14	Curettes and Scalers · Columbia	Asa60	G4
								1701-2	Excavators - spoons	Asa60	F13	1806-2RL	Curettes and Scalers · Columbia	Asa60	G4
								1702-6	Excavators - spoons	Asa60	F14	1806-412	Curettes and Scalers · Columbia	Asa60	G4
								1703-14	Excavators - spoons	Asa60	F14	1806-414	Curettes and Scalers · Columbia	Asa60	G4
								1704-17	Excavators - spoons	Asa60	F14	1806-4RL	Curettes and Scalers · Columbia	Asa60	G4
								1704-17W	Excavators - oval spoons	Asa60	F15	1807-02	Gracey curettes · Gracey	Asa60	G11
								1705-18	Excavators - spoons	Asa60	F14	1807-02AF	Gracey curettes - AF · Gracey	Asa60	G12
								1705-18W	Excavators - oval spoons	Asa60	F15	1807-02MF	Gracey curettes - MF · Gracey	Asa60	G13
												1807-04	Gracey curettes · Gracey	Asa60	G11
												1807-04AF	Gracey curettes - AF · Gracey	Asa60	G12
												1807-04MF	Gracey curettes - MF · Gracey	Asa60	G13
												1807-06	Gracey curettes · Gracey	Asa60	G11
												1807-06AF	Gracey curettes - AF · Gracey	Asa60	G12
												1807-06MF	Gracey curettes - MF · Gracey	Asa60	G13
												1807-08	Gracey curettes · Gracey	Asa60	G11
												1807-08AF	Gracey curettes - AF · Gracey	Asa60	G12
												1807-08MF	Gracey curettes - MF · Gracey	Asa60	G13
												1807-10	Gracey curettes · Gracey	Asa60	G11

code	description	handle	page	code	description	handle	page	code	description	handle	page	code	description	handle	page	
1807-11MD	Gracey curettes · Mesial-Distal · Gracey	Asa60	G11	1831-33	Curettes and Scalars · Jacquette	Asa60	G9	1858-1	Periosteals and Elevators · König		E25	2013-2L	Bone curettes · U.S.A. model		G21	
1807-12	Gracey curettes · Gracey	Asa60	G11	1831-35	Curettes and Scalars · Jacquette	Asa60	G9	G18			G18	2013-2R	Bone curettes · U.S.A. model		G21	
1807-12AF	Gracey curettes · AF · Gracey	Asa60	G12	1831-38	Curettes and Scalars · Jacquette	Asa60	G9	1870-1	Mouth gags · Molt		C33	2014-3	Bone curettes		C45	
1807-12MF	Gracey curettes · MF · Gracey	Asa60	G13	1832-1	Bone chisels and gouges · Gardner		G27	1870-2	Mouth gags · Molt		C33				E21	
1807-13MD	Gracey curettes · Mesial-Distal · Gracey	Asa60	G11	1832-2	Bone chisels and gouges · Gardner		G27	1871-1	Mouth gags · Roser-Koenig		C33	2015-0	Bone curettes · Williger		G21	
1807-14	Gracey curettes · Gracey	Asa60	G11	1832-5	Bone chisels and gouges · Gardner		G27	1871-2	Mouth gags · Roser-Koenig		C33	2015-00	Bone curettes · Williger		G21	
1807-14AF	Gracey curettes · AF · Gracey	Asa60	G12	1832-5R	Bone chisels and gouges · Gardner		G27	1880	Mallets · Partsch		E16	2015-1	Bone curettes · Williger		G21	
1807-14MF	Gracey curettes · MF · Gracey	Asa60	G13	1832-6	Bone chisels and gouges · Gardner		G27	1881	Mallets · Mead		E16	2016-0	Bone curettes		G21	
1807-16	Gracey curettes · Gracey	Asa60	G11	1833-1W	Bone chisels and gouges · Wakefield		G27	1881-R	Inserts for mallets · Teflon		E16	2016-00	Bone curettes		G21	
1807-16AF	Gracey curettes · AF · Gracey	Asa60	G12	1833-2W	Bone chisels and gouges · Wakefield		G27	1882	Mallets · Mead		G29	2016-1	Bone curettes		G21	
1807-16MF	Gracey curettes · MF · Gracey	Asa60	G13	1834-3	Bone chisels and gouges · Buckley		G27	1884	Mallets · Vickers		G29	2100-CS	Cone-socket Mouth Mirrors - Handles	Octagonal	B20	
1807-18	Gracey curettes · Gracey	Asa60	G11	1835-3	Bone chisels and gouges · Partsch		G28	1885	Mallets · Herbert		G29	2101-CS	Cone-socket Mouth Mirrors - Handles	Asa60	B20	
1808-1	Curettes and Scalars · De Marco	Asa60	G5	1835-4	Bone chisels and gouges · Partsch		G28	1890-1F	Grinding stones · fine grain		G32	2102-CS	Cone-socket Mouth Mirrors - Handles	Exagonal	B20	
1808-2	Curettes and Scalars · De Marco	Asa60	G5	1835-5	Bone chisels and gouges · Partsch		G28	1890-1M	Grinding stones · medium grain		G32	2104-B	Simple stem Mouth Mirrors - Handles	Alu80	B19	
1809-1	Curettes and Scalars · Goldman-Fox	Asa60	G6	1835-6	Bone chisels and gouges · Partsch		G28	1890-2	Grinding stones		G32	2104-C	Simple stem Mouth Mirrors - Handles	Alu80	B19	
1809-2	Curettes and Scalars · Goldman-Fox	Asa60	G6	1836-3	Bone chisels and gouges · Partsch		G28	1890-3	Grinding stones		G32	2104-G	Simple stem Mouth Mirrors - Handles	Alu80	B19	
1809-21	Curettes and Scalars · Goldman-Fox	Asa60	G6	1836-4	Bone chisels and gouges · Partsch		G28	1890-4	Grinding stones		G32	2104-R	Simple stem Mouth Mirrors - Handles	Alu80	B19	
1809-3	Curettes and Scalars · Goldman-Fox	Asa60	G6	1836-5	Bone chisels and gouges · Partsch		G28	1890-5	Grinding stones		G32	2104-V	Simple stem Mouth Mirrors - Handles	Alu80	B19	
1809-4	Curettes and Scalars · Goldman-Fox	Asa60	G6	1836-6	Bone chisels and gouges · Partsch		G28	1890-6	Grinding stones		G33	2200E-4	Simple stem Mouth Mirrors		B18	
1809-5	Curettes and Scalars · Goldman-Fox	Asa60	G6	1837-3	Bone chisels and gouges · Partsch		G28	1890-7	Grinding stones		G33	2200E-5	Simple stem Mouth Mirrors		B18	
1809-6	Curettes and Scalars · Goldman-Fox	Asa60	G6	1837-4	Bone chisels and gouges · Partsch		G28	1891-1	Grinding stones		G33	2200E-6	Simple stem Mouth Mirrors		B18	
1810-07	Files · Hirschfeld	Asa60	G22	1837-5	Bone chisels and gouges · Partsch		G28	1900-1L	Scalers · left	Asa60	G15	2201E-4	Simple stem Mouth Mirrors		B18	
1811-37	Chisels · back-action · Rhodes	Asa60	G26	1837-6	Bone chisels and gouges · Partsch		G28	1900-1R	Scalers · right	Asa60	G15	2201E-5	Simple stem Mouth Mirrors		B18	
1812-02S	Files · Sugarman	Asa60	G22	1838-3	Bone chisels and gouges · Partsch		G28	1900-2L	Scalers · left	Asa60	G15	2210E-4	Cone-socket Mouth Mirrors		B20	
1812-04S	Files · Sugarman	Asa60	G22	1838-4	Bone chisels and gouges · Partsch		G28	1900-2R	Scalers · right	Asa60	G15	2210E-5	Cone-socket Mouth Mirrors		B20	
1813-10	Files · Schluger	Asa60	G22	1838-5	Bone chisels and gouges · Partsch		G28	1900-M23	Scalers · universal scaler	Asa60	G14	2211E-4	Cone-socket Mouth Mirrors - Handles		B20	
1815-11	Gingivectomy knives · Goldman-Fox	Asa60	G25	1838-6	Bone chisels and gouges · Partsch		G28	1901-1	Scalers	Asa60	G15	2211E-5	Cone-socket Mouth Mirrors - Handles		B20	
1815-7	Gingivectomy knives · Goldman-Fox	Asa60	G25	1839-1	Freer single cut chisels · Freer		E16	1902-1	Scalers · Towner Jacquette	Asa60	G14	2220E-4	Simple stem Mouth Mirrors · Rhodium		B18	
1815-8	Gingivectomy knives · Goldman-Fox	Asa60	G25	1839-2	Freer single cut chisels · Freer		E16	1902-2	Scalers · Towner Jacquette	Asa60	G14	2220E-5	Simple stem Mouth Mirrors · Rhodium		B18	
1815-9	Gingivectomy knives · Goldman-Fox	Asa60	G25	1839-3	Freer single cut chisels · Freer		E16	1903	Scalers · Towner	Asa60	G14	2221-4	Simple stem Mouth Mirrors · Titanium		B18	
1816-04	Gingivectomy knives · Buck	Asa60	G25	1840-1	Graduated chisels · straight		E17	1904-H5	Scalers	Asa60	G14	2221-5	Simple stem Mouth Mirrors · Titanium		B18	
1816-06	Gingivectomy knives · Buck	Asa60	G24	1840-2	Graduated chisels · curved		E17	1904-H6	Scalers	Asa60	G14	2230-5	Simple stem Mouth Mirrors		B18	
1817-02	Gingivectomy knives · Sanders	Asa60	G25	1840-3	Graduated chisels · straight		E17	1905-02	Scalers	Asa60	G14	2231-5CS	Cone-socket Mouth Mirrors		B20	
1817-05	Gingivectomy knives · Sanders	Asa60	G25	1840-4	Graduated chisels · curved		E17	1906-33	Scalers	Asa60	G15	2240-1	Simple stem Mouth Mirrors - Handles		B19	
1818-20	Gingivectomy knives · USC Towner (University of South California)	Asa60	G25	1841-1	Trephine graduated burs		E34	1909-H5	Scalers	Asa60	G15	2240-2	Simple stem Mouth Mirrors - Handles		B19	
1819-CK3	Gingivectomy knives · Crane-Kaplan	Asa60	G25	1841-2	Trephine graduated burs		E34	1909-H6	Scalers	Asa60	G15	2240-3	Simple stem Mouth Mirrors - Handles		B19	
1820-Z	Curettes and Scalars · Zerfing-Chisel	Asa60	G4	1841-3	Trephine graduated burs		E34	1909-H7	Scalers · Hygienist	Asa60	G15	2240-4	Simple stem Mouth Mirrors - Handles		B19	
1821-02	Curettes and Scalars · Barnhart	Asa60	G5	1841-4	Trephine graduated burs		E34	2000-1	Bone curettes · Hemingway	Asa60	C45	2250-1	Photographic Mirrors · occlusal surfaces		B17	
1821-06	Curettes and Scalars · Barnhart	Asa60	G5	1844-3	Mucotomes · straight		E26	E21			G20	2250-2	Photographic Mirrors · occlusal surfaces		B17	
1822-ME1	Curettes and Scalars	Asa60	G5	1844-3C	Mucotomes · curved		E26	2000-2	Bone curettes · Hemingway	Asa60	C45	2250-3	Photographic Mirrors · buccal surfaces		B17	
1823-R04	Curettes and Scalars · Rule	Asa60	G5	1844-4	Mucotomes · straight		E26	E21			G20	2250-4	Photographic Mirrors · lingual surfaces		B17	
1824-14	Curettes and Scalars · anterior · Indiana University	Asa60	G5	1844-4C	Mucotomes · curved		E26	2000-3	Bone curettes · Hemingway	Asa60	C45					
1824-18	Curettes and Scalars · posterior · Indiana University	Asa60	G5	1844-5	Mucotomes · straight		E26	E21			G20					
1825-12	Curettes and Scalars · Mc Call	Asa60	G7	1844-5C	Mucotomes · curved		E26	G20			G20					
1825-12A	Curettes and Scalars · Mc Call	Asa60	G7	1844-6	Mucotomes · straight		E26	2000-4	Bone curettes · Hemingway	Asa60	G20					
1825-14	Curettes and Scalars · Mc Call	Asa60	G7	1844-6C	Mucotomes · curved		E26	2001-85	Bone curettes · Lucas	Asa60	G20					
1825-14S	Curettes and Scalars · Mc Call	Asa60	G7	1846	Bone mill		E27	2001-86	Bone curettes · Lucas	Asa60	G20					
1825-18S	Curettes and Scalars · Mc Call	Asa60	G7	1849-1	Periosteals and Elevators · Partsch	Asa60	E24	2001-87	Bone curettes · Lucas	Asa60	G20					
1825-20	Curettes and Scalars · Mc Call	Asa60	G7	G17			G17	2001-88	Bone curettes · Lucas	Asa60	G20					
1826-T03	Curettes and Scalars · Taylor	Asa60	G8	1855-22	Periosteals and Elevators · retractor · Seldin		E25	2002-6	Mirrors (mouth) parallelometer		B19					
1827-204	Curettes and Scalars	Asa60	G8	G18			G18	2003-1	Bone files · Polokoff		G23					
1827-204S	Curettes and Scalars	Asa60	G8	1855-23	Periosteals and Elevators · retractor · Seldin		E25	2004-33	Bone files		G23					
1829-CK6	Curettes and Scalars · Crane-Kaplan	Asa60	G8	1856-1	Periosteals and Elevators · Williger		E25	2005-45	Bone files · Miller		G23					
1829-CK6S	Curettes and Scalars · Mini Crane-Kaplan	Asa60	G8	G19			G19	2005-64	Bone files · Miller		E21					
1830-YG08	Curettes and Scalars · Younger-Good	Asa60	G8	1856-2	Periosteals and Elevators · Williger		E25	2006-10	Bone files		E21					
1831-32	Curettes and Scalars · Jacquette	Asa60	G9	G19			G19	2007-12A	Bone files		G23					
				1857-1	Periosteals and Elevators · Williger		E25	2007-12CA	Bone files		G23					
				G19			G19	2008-12	Bone files		G23					
				1857-2	Periosteals and Elevators · Williger		E25	2013-2	Bone curettes · U.S.A. model		G21					
				G19			G19									

code	description	handle	page	code	description	handle	page	code	description	handle	page	code	description	handle	page
2250-5	Photographic Mirrors · lingual surfaces		B17	2617-2	Retractors · left, sharp · Williger		C35	2730-2	Stainless steel instrument trays · insert frame for 23 instruments		I5	2771-2R	Stainless steel instrument cassettes · medium - for 5 instruments - Red		I2
2300-D	Crown removers		F40	2617-3	Retractors · right, sharp · Williger		C35	2730-3	Rubber dam instrument kit · insert frame		F10	2771-2V	Stainless steel instrument cassettes · medium - for 5 instruments - Green		I2
2300-S	Crown removers		F40	2617-33	Retractors · right, sharp · Williger		C35	2730-4	Stainless steel instrument trays · insert frame for 8 instruments		I7	2771-G	Holders (instruments) · for 5 places - Blue - silicone		I3
2301	Tips for crown removers		F40	2618-1	Retractors · straight, blunt · Williger		C35	2730-5	Stainless steel instrument trays · insert frame for 4 instruments		I7	2771-GA	Holders (instruments) · for 5 places - Orange - silicone		I3
2302	Tips for crown removers		F40	2618-2	Retractors · left, blunt · Williger		C35	2731-1	Rubber dam instrument kit		F11	2771-GR	Holders (instruments) · for 5 places - Red - silicone		I3
2305-D	Crown removers		F40	2620-1	Retractors · Middeldorpf		C37	2737-1	Stainless steel trays		I12	2771-GV	Holders (instruments) · for 5 places - Green - silicone		I3
2306	Tips for crown removers		F40	2620-2	Retractors · Middeldorpf		E12	2737-2	Stainless steel trays		I12	2772-1	Stainless steel instrument cassettes · mini - for 5 instruments - Blue		I3
2307	Tips for crown removers		F40	2620-3	Retractors · Middeldorpf		C37	2737-3	Stainless steel trays		I12	2772-1A	Stainless steel instrument cassettes · mini - for 5 instruments - Orange		I3
2308	Tips for crown removers		F40	2620-3	Retractors · Middeldorpf		C37	2737-4	Stainless steel trays		I12	2772-1R	Stainless steel instrument cassettes · mini - for 5 instruments - Red		I3
2320	Crown spreaders		F40	2621-1	Retractors · Langenbeck		C36	2750-1	Drinking cup dispensers		A20	2772-1V	Stainless steel instrument cassettes · mini - for 5 instruments - Green		I3
2331-1	Copper rings removing pliers · straight · Furrer		F43	2621-2	Retractors · Langenbeck		C36	2750-2	Drinking cup dispensers		A20	2772-G	Frame · for 10 places - Blue - silicone		I3
2331-2	Copper rings removing pliers · curved · Furrer		F43	2621-3	Retractors · Langenbeck		C36	2751-1	Dispensers (cotton pellet) stainless steel		I19	2772-GA	Frame · for 10 places - Orange - silicone		I3
2340-0	Crown spreaders		F41	2621-4	Retractors · Langenbeck		C36	2770-1	Stainless steel instrument cassettes · large - for 20 instruments - Blue		I2	2772-GR	Frame · for 10 places - Red - silicone		I3
2340-1	Crown spreaders		F41	2621-5	Retractors · Langenbeck		C36	2770-1A	Stainless steel instrument cassettes · large - for 20 instruments - Orange		I2	2772-GV	Frame · for 10 places - Green - silicone		I3
2340-2	Crown spreaders		F41	2622-1	Retractors · Langenbeck		C36	2770-1R	Stainless steel instrument cassettes · large - for 20 instruments - Red		I2	2773-G	Frame · for 5 places - Blue - silicone		I3
2340-3	Crown spreaders		F41	2622-2	Retractors · Langenbeck		C36	2770-1V	Stainless steel instrument cassettes · large - for 20 instruments - Green		I2	2773-GA	Frame · for 5 places - Orange - silicone		I3
2400	Direct bond bracket holders		H34	2622-3	Retractors · Langenbeck		C36	2770-2	Stainless steel instrument cassettes · large - for 15 instruments - Blue		I2	2773-GR	Frame · for 5 places - Red - silicone		I3
2401	Direct bond bracket holders		H34	2622-4	Retractors · Langenbeck		C36	2770-2A	Stainless steel instrument cassettes · large - for 15 instruments - Orange		I2	2773-GV	Frame · for 5 places - Green - silicone		I3
2402	Direct bond bracket holders		H34	2623-1	Retractors · Kocher		C36	2770-2R	Stainless steel instrument cassettes · large - for 15 instruments - Red		I2	2774	Spare part (cassettes) · knob complete of washers		I3
2410	Band pusher · Mershon		H34	2623-2	Retractors · Kocher		C36	2770-2V	Stainless steel instrument cassettes · large - for 15 instruments - Green		I2	2775	Clips for locking trays for scissors		I3
2411	Band setter · band setter		H34	2624-1	Retractors · Kocher		C36	2770-3	Stainless steel instrument cassettes · large - for 10 instruments - Blue		I2	2780-1A	Stainless steel instrument cassettes · implant - h. 60 mm		I2
2412	Band pusher · used in all heat sterilizers		H34	2624-2	Retractors · Kocher		C36	2770-3A	Stainless steel instrument cassettes · large - for 10 instruments - Orange		I2	2800-L1	Perforated aluminum impression trays		J36
2450	Separating pliers · for elastics and separators		H35	2625-1	Ramus retractors for nasal spine		C36	2770-3R	Stainless steel instrument cassettes · large - for 10 instruments - Red		I2	2800-L2	Perforated aluminum impression trays		J36
2500-1	Crown pliers · Böhm		F43	2626-1	Ramus retractors for nasal spine		C36	2770-3V	Stainless steel instrument cassettes · large - for 10 instruments - Green		I2	2800-L2D	Perforated aluminum impression trays		J36
2500-2	Crown pliers · Böhm		F43	2627	Retractors		E12	2770-G	Holders (instruments) · for 10 places - Blue - silicone		I3	2800-L2S	Perforated aluminum impression trays		J36
2550-1	Calipers · for wax · Iwanson		F42	2628-1	Labial retractors		C37	2770-GA	Holders (instruments) · for 10 places - Orange - silicone		I3	2800-L3	Perforated aluminum impression trays		J36
2550-2	Calipers · for metal · Iwanson		F42	2628-2	Vestibular retractor		C37	2770-GR	Holders (instruments) · for 10 places - Red - silicone		I3	2800-L4	Perforated aluminum impression trays		J36
2555	Calipers · Boley		F42	2650-02	Antrum probes · Bowman		C37	2770-GV	Holders (instruments) · for 10 places - Green - silicone		I3	2800-L4D	Perforated aluminum impression trays		J36
2556-1	Calipers · aluminum, graded in millimeters and inches		K30	2650-08	Antrum probes · Bowman		C37	2771-1	Stainless steel instrument cassettes · medium - for 10 instruments - Blue		I2	2800-L4S	Perforated aluminum impression trays		J36
2556-2	Calipers · aluminum, graded in millimeters and inches · Townley		K30	2651-1	Antrum probes		C37	2771-1A	Stainless steel instrument cassettes · medium - for 10 instruments - Orange		I2	2800-L5	Perforated aluminum impression trays		J36
2556-3	Calipers · Jameson		K30	2651-2	Antrum probes		C37	2771-1R	Stainless steel instrument cassettes · medium - for 10 instruments - Red		I2	2800-L6	Perforated aluminum impression trays		J36
2556-4	Calipers		E33	2700-G	Stainless steel instrument trays · insert frame for 7 instruments		I6	2771-1V	Stainless steel instrument cassettes · medium - for 10 instruments - Green		I2	2800-L6D	Perforated aluminum impression trays		J36
2557-1	Calipers		K30	2700-L	Stainless steel instrument trays · non-perforated base		I6	2771-2	Stainless steel instrument cassettes · medium - for 5 instruments - Blue		I2	2800-L6S	Perforated aluminum impression trays		J36
2601	Lip retractors · Columbia		C34	2700-U	Stainless steel instrument trays · non-perforated lid		I6	2771-2A	Stainless steel instrument cassettes · medium - for 5 instruments - Orange		I2				
2602-1	Lip retractors · Sternberg		C34	2702-L	Stainless steel instrument trays · perforated base		I6								
2602-2	Lip retractors · Sternberg		C34	2702-U	Stainless steel instrument trays · perforated lid		I6								
2602-3	Lip retractors · Sternberg		C34	2720-L	Stainless steel instrument trays · non-perforated base		I5								
2604	Tongue depressors · cheek retractor · University of Minnesota		C34	2720-U	Stainless steel instrument trays · non-perforated lid		I4								
2605	Tongue depressors		C34	2721-L	Stainless steel instrument trays · perforated base		I4								
2606	Tongue depressors		C34	2721-U	Stainless steel instrument trays · perforated lid		I4								
2607	Tongue depressors · Buchwald		C34	2723-L	Stainless steel instrument trays · non-perforated base		I7								
2608	Tongue depressors · Brünings		C34	2723-U	Stainless steel instrument trays · non-perforated lid		I7								
2609-2	Lip retractors · Orringer medium		C34	2724-L	Stainless steel instrument trays · non-perforated base		I7								
2611-1	Retractors · blunt		C35	2724-U	Stainless steel instrument trays · non-perforated lid		I7								
2611-2	Retractors · blunt		C35	2730-1	Stainless steel instrument trays · insert frame for 16 instruments		I5								
2613-1	Retractors · sharp · Senn-Miller		C35												
2613-2	Retractors · blunt · Senn-Miller		C35												
2615-1	Retractors · Kilner		C35												
2616-1	Retractors · Farabeuf		C35												
2617-1	Retractors · straight, sharp · Williger		C35												

code	description	handle	page	code	description	handle	page	code	description	handle	page	code	description	handle	page
2816-U3	Perforated aluminum impression trays - ORTHOBABY for children		J39	2900E-TTS15	Multi-color saliva ejectors		A5	3030	Clamp forceps · Ivory lightweight		F9	3052-W7	Rubber dam clamps · wingless clamp		F6
2819-OCG	Partial occlusal stainless steel impression trays		J40	2900E-VT13	Multi-color saliva ejectors		A4	3031	Clamp forceps · Brewer		F9	3052-W8	Rubber dam clamps · wingless clamp		F7
2819-OCP	Partial occlusal stainless steel impression trays		J40	2900E-VT15	Multi-color saliva ejectors		A4	3032	Punching forceps · Ainsworth		F8	3052-W8A	Rubber dam clamps · wingless clamp		F6
2850-8	Orthodontic polycarbonate impression trays - ORTHOBABY for children		J42	2900E-VTS15	Multi-color saliva ejectors		A5	3033	Punching forceps · Ivory		F8	3070-5	Matrix retainers · Ivory		F46
2851-7	Polycarbonate impression trays - edentulous		J43	2900E-ZT13	Multi-color saliva ejectors		A5	3034	Clamp forceps · Stoke		F9	3070-6	Matrix retainers · Ivory		F46
2851-13	Polycarbonate impression trays - edentulous		J43	2900E-ZT15	Multi-color saliva ejectors		A5	3040-1	Rubber dam instruments		F9	3070-7	Matrix retainers · Ivory		F46
2852-12	Polycarbonate impression trays		J42	2901E-AT13	Multi-color saliva ejectors		A4	3041-1	Rubber dam instruments		F9	3071	Matrix retainers · Ivory		F46
2853E-1	Disposable plastic impression trays		A23	2901E-AT15	Multi-color saliva ejectors		A4	3045	Rubber dam instruments · latex dam vacuum packed 36 pcs/pack		F8	3072	Matrix retainers · Didner		F46
2853E-1DS	Disposable plastic impression trays		A23	2901E-TT13	Multi-color saliva ejectors		A4	3050-60	Rubber dam clamps · wingless clamp		F5	3073-1	Matrix retainers · Tofflemire universal		F46
2853E-2	Disposable plastic impression trays		A23	2901E-TT15	Multi-color saliva ejectors		A4	3051-202	Rubber dam clamps · winged clamp		F7	3073-2	Matrix retainers · Tofflemire Junior		F46
2853E-2DS	Disposable plastic impression trays		A23	2901E-VT13	Multi-color saliva ejectors		A4	3051-205	Rubber dam clamps · wingless clamp		F7	3073-3	Matrix retainers · Tofflemire Senior		F46
2853E-3	Disposable plastic impression trays		A23	2901E-VT15	Multi-color saliva ejectors		A4	3051-210	Rubber dam clamps · winged clamp		F4	3081	Matrix · Tofflemire		F47
2853E-4	Disposable plastic impression trays		A23	2901E-VT15	Multi-color saliva ejectors		A4	3051-212	Rubber dam clamps · winged clamp		F4	3081-1	Matrix · Tofflemire		F47
2880-FR	Perforated aluminum impression trays for implantology · bur in tungsten carbide		J38	2902-L	Surgical stainless steel saliva ejectors		C44	3051-26	Rubber dam clamps · wingless clamp		F6	3081-2	Matrix · Tofflemire		F47
2880-L1	Perforated aluminum impression trays for implantology		J38	2902-M	Surgical stainless steel saliva ejectors		C44	3051-29	Rubber dam clamps · winged clamp		F5	3081-3	Matrix · Tofflemire		F47
2880-L2	Perforated aluminum impression trays for implantology		J38	2902-S	Surgical stainless steel saliva ejectors		C44	3051-51	Rubber dam clamps · wingless clamp		F6	3082-5	Bands for matrix retainers		F47
2880-L3	Perforated aluminum impression trays for implantology		J38	2903E-BA155	Soft-tip saliva ejectors - Total-Comfort		A3	3052-0	Rubber dam clamps · winged clamp		F4	3082-6	Bands for matrix retainers		F47
2880-L4	Perforated aluminum impression trays for implantology		J38	2903E-BAS155	Soft-tip saliva ejectors - Total-Comfort		A3	3052-00	Rubber dam clamps · winged clamp		F4	3082-7	Bands for matrix retainers		F47
2880-L5	Perforated aluminum impression trays for implantology		J38	2903E-BT155	Soft-tip saliva ejectors - Total-Comfort		A3	3052-1	Rubber dam clamps · winged clamp		F5	3101	Accessories · alcohol burner		I19
2880-L6	Perforated aluminum impression trays for implantology		J38	2903E-BTS155	Soft-tip saliva ejectors - Total-Comfort		A3	3052-12A	Rubber dam clamps · winged, serrated clamp		F7	3101-1	Accessories · spare wick		I19
2880-U1	Perforated aluminum impression trays for implantology		J38	2903E-TA155	Soft-tip saliva ejectors - Total-Comfort		A3	3052-13A	Rubber dam clamps · winged, serrated clamp		F7	3200	Napkins - AsaRainbow · patient bib chain		A7
2880-U2	Perforated aluminum impression trays for implantology		J38	2903E-TAS155	Soft-tip saliva ejectors - Total-Comfort		A3	3052-14	Rubber dam clamps · winged clamp		F6	3251E-B/9	Bibs		A19
2880-U3	Perforated aluminum impression trays for implantology		J38	2903E-TT155	Soft-tip saliva ejectors - Total-Comfort		A3	3052-14A	Rubber dam clamps · winged clamp		F7	3251E-C/9	Bibs		A19
2880-U4	Perforated aluminum impression trays for implantology		J38	2903E-TTS155	Soft-tip saliva ejectors - Total-Comfort		A3	3052-14T	Rubber dam clamps · winged, serrated clamp		F6	3251E-D/9	Bibs		A19
2880-U5	Perforated aluminum impression trays for implantology		J38	2904-10	Surgical stainless steel saliva ejectors · Frazier		C44	3052-1T	Rubber dam clamps · winged, serrated clamp		F5	3251E-G/9	Bibs		A19
2880-U6	Perforated aluminum impression trays for implantology		J38	2904-12	Surgical stainless steel saliva ejectors · Frazier		C44	3052-2	Rubber dam clamps · winged clamp		F5	3251E-L/9	Bibs		A19
2900E-AT13	Multi-color saliva ejectors		A4	2904-6	Surgical stainless steel saliva ejectors · Frazier		C44	3052-2A	Rubber dam clamps · winged clamp		F5	3251E-LI/9	Bibs		A19
2900E-AT15	Multi-color saliva ejectors		A4	2904-8	Surgical stainless steel saliva ejectors · Frazier		C44	3052-2AT	Rubber dam clamps · winged, serrated clamp		F5	3251E-O/9	Bibs		A19
2900E-ATS15	Multi-color saliva ejectors		A5	2905-155	Surgical aspirator tips		C44	3052-2T	Rubber dam clamps · winged, serrated clamp		F5	3251E-O/V/9	Bibs		A19
2900E-BBS15	Multi-color saliva ejectors		A5	2905-AD	Surgical aspirator tips		C44	3052-3	Rubber dam clamps · winged clamp		F5	3252E-B/9	Bibs		A19
2900E-BT13	Multi-color saliva ejectors		A4	2908E-AT13	Mint-scented saliva ejectors - AsaFresh		A2	3052-4	Rubber dam clamps · winged clamp		F6	3252E-C/9	Bibs		A19
2900E-BT15	Multi-color saliva ejectors		A4	2908E-AT15	Mint-scented saliva ejectors - AsaFresh		A2	3052-7	Rubber dam clamps · winged clamp		F6	3252E-D/9	Bibs		A19
2900E-GT13	Multi-color saliva ejectors		A4	2908E-BBS15	Mint-scented saliva ejectors - AsaFresh		A2	3052-8	Rubber dam clamps · winged clamp		F7	3252E-G/9	Bibs		A19
2900E-GT15	Multi-color saliva ejectors		A4	2908E-TCS15	Mint-scented saliva ejectors - AsaFresh		A2	3052-8A	Rubber dam clamps · winged clamp		F6	3252E-L/9	Bibs		A19
2900E-LT13	Multi-color saliva ejectors		A4	2908E-TT13	Mint-scented saliva ejectors - AsaFresh		A2	3052-9	Rubber dam clamps · winged clamp		F4	3252E-LI/9	Bibs		A19
2900E-LT15	Multi-color saliva ejectors		A4	2908E-TT15	Mint-scented saliva ejectors - AsaFresh		A2	3052-9T	Rubber dam clamps · winged clamp		F4	3252E-L/V/9	Bibs		A19
2900E-OT13	Multi-color saliva ejectors		A5	2908E-TTS15	Mint-scented saliva ejectors - AsaFresh		A2	3052-W0	Rubber dam clamps · wingless clamp		F5	3301E-L	Examination gloves		A15
2900E-OT15	Multi-color saliva ejectors		A5	2908E-VT13	Mint-scented saliva ejectors - AsaFresh		A2	3052-W1	Rubber dam clamps · wingless clamp		F5	3301E-M	Examination gloves		A15
2900E-RT13	Multi-color saliva ejectors		A5	2908E-VT15	Mint-scented saliva ejectors - AsaFresh		A2	3052-W14	Rubber dam clamps · wingless clamp		F6	3301E-S	Examination gloves		A15
2900E-RT15	Multi-color saliva ejectors		A5	2908E-VTS15	Mint-scented saliva ejectors - AsaFresh		A2	3052-W14A	Rubber dam clamps · wingless clamp		F7	3301E-XS	Examination gloves		A15
2900E-TCS15	Multi-color saliva ejectors		A5					3052-W2	Rubber dam clamps · wingless clamp		F5	3303E-L	Examination gloves		A15
2900E-TT13	Multi-color saliva ejectors		A4					3052-W2A	Rubber dam clamps · wingless clamp		F5	3303E-M	Examination gloves		A15
2900E-TT15	Multi-color saliva ejectors		A4					3052-W3	Rubber dam clamps · wingless clamp		F6	3303E-S	Examination gloves		A15
								3052-W4	Rubber dam clamps · wingless clamp		F7	3303E-XS	Examination gloves		A15
												3305-L	Examination gloves		A15
												3305-M	Examination gloves		A15
												3305-S	Examination gloves		A15
												3305-XS	Examination gloves		A15
												3309E-L	Examination gloves		A16
												3309E-M	Examination gloves		A16
												3309E-S	Examination gloves		A16
												3309E-XS	Examination gloves		A16
												3310E-L	Examination gloves		A16
												3310E-M	Examination gloves		A16
												3310E-S	Examination gloves		A16
												3310E-XS	Examination gloves		A16

code	description	handle	page	code	description	handle	page	code	description	handle	page	code	description	handle	page	
3311E-L	Examination gloves		A16	3520-1	Cotton rolls		A12	5011-19	Articulators - spare parts - hinge rod spring		K9	5053-1	Articulators - spare parts - magnetic rod		K9	
3311E-M	Examination gloves		A16	3520-2	Cotton rolls		A12	5011-20	Articulators - spare parts - back rod support		K9	5053-2	Articulators - spare parts - rod ferrule		K9	
3311E-S	Examination gloves		A16	3520-3	Cotton rolls		A12	5011-21	Articulators - spare parts - back rod		K9	5053-3	Articulators - spare parts - table for magnetic rod		K9	
3311E-XS	Examination gloves		A16	3600E	Synthetic instant ice		A22	5011-22	Articulators - spare parts - adjusting screw		K9	5054	Articulators - spare parts - occlusal table assembly (5050-4 + 5051 + 5050-2)		K9	
3312E-L	Examination gloves		A16	3700-B	Dappen dishes		A9	5011-23	Articulators - spare parts - adjusting screw locknut		K9	5100	Amalgam/wax carvers · Hylin		K14	
3312E-M	Examination gloves		A16	3700-C	Dappen dishes		A9	5020	Easy Bow · complete set		K10	5100-1	Amalgam/wax carvers · graded handle in mm · Hylin		K14	
3312E-S	Examination gloves		A16	3700-G	Dappen dishes		A9	5021	Easy Bow · face bow		K10	5101	Amalgam/wax carvers · Hylin-Le Cron		K14	
3312E-XS	Examination gloves		A16	3700-MX	Dappen dishes		A8	5022	Easy Bow · fork holder		K10	5102	Amalgam/wax carvers · Hylin		K14	
3313E-L	Examination gloves		A17	3700-N	Dappen dishes		A9	5023-1	Easy Bow · fork		K10	5103	Amalgam/wax carvers · Hylin		K14	
3313E-M	Examination gloves		A17	3700-R	Dappen dishes		A9	5023-2	Easy Bow · fork		K10	5104	Amalgam/wax carvers		K14	
3313E-S	Examination gloves		A17	3710	Plastic syringes		A20	5023-3	Easy Bow · fork		K10	5105	Amalgam/wax carvers · Le Cron		K15	
3313E-XS	Examination gloves		A17	3818-B	Cups		A20	5024	Easy Bow · transfer table		K10	5106	Amalgam/wax carvers · Le Cron		K15	
3314E-L	Examination gloves		A17	5000-1	Articulators - spare parts - mounting plate		K6	5030	Articulators - average values		K4	5107	Amalgam/wax carvers · Le Cron		K15	
3314E-M	Examination gloves		A17	5000-1M	Articulators - spare parts - magnetic mounting plate - complete		K9	5030-2	Articulators - spare parts - occlusal table		K9	5108	Amalgam/wax carvers · Le Cron		K15	
3314E-S	Examination gloves		A17	5000-2	Articulators - spare parts - occlusal table		K9	5030-3	Articulators - spare parts - incisal guide rod		K9	5109	Amalgam/wax carvers · Zahle		K15	
3314E-XS	Examination gloves		A17	5000-3	Articulators - spare parts - incisal guide rod		K9	5030-6	Articulators - spare parts - locking knob for spacer		K9	5110	Amalgam/wax carvers · Zahle		K15	
3315E-L	Examination gloves		A17	5000-4	Articulators - spare parts - incisal guide table (10°)		K9	5030-9	Articulators - spare parts - condylar guidance		K9	5111	Amalgam/wax carvers · Zahle		K16	
3315E-M	Examination gloves		A17	5000-4N	Articulators - spare parts - incisal guide table (10°)		K9	5030-10	Articulators - spare parts - bearing rod		K9	5112-1	Amalgam/wax carvers · P.K. Thomas	Asa60	K17	
3315E-S	Examination gloves		A17	5000-5	Articulators - spare parts - metallic locking knob		K9	5030-29	Articulators - spare parts - spacer		K7	5112-1AL	Amalgam/wax carvers · P.K. Thomas	Alu80	K17	
3315E-XS	Examination gloves		A17	5000-6	Articulators - spare parts - locking knob		K9	5032	Articulators - average values		K5	5112-2	Amalgam/wax carvers · P.K. Thomas	Asa60	K17	
3316E-L	Examination gloves		A17	5000-7	Articulators - spare parts - adjusting screw - side shift		K9	5032-16	Articulators - spare parts - inclined contrast table		K9	5112-2AL	Amalgam/wax carvers · P.K. Thomas	Alu80	K17	
3316E-M	Examination gloves		A17	5000-8	Articulators - spare parts - incisal pin		K9	5032-17	Articulators - spare parts - hinge rod		K9	5112-3	Amalgam/wax carvers · Asa Com 1/1B · P.K. Thomas	Asa60	F48	
3316E-S	Examination gloves		A17	5000-12	Articulators - spare parts - side shift spring		K9	5032-21	Articulators - spare parts - back rod		K9	5112-3AL	Amalgam/wax carvers · P.K. Thomas	Alu80	K17	
3316E-XS	Examination gloves		A17	5000-13	Articulators - spare parts - side shift cylinder		K9	5032-22	Articulators - spare parts - adjusting screw		K9	5112-4	Amalgam/wax carvers · Asa Com 13/13B · P.K. Thomas	Asa60	F50	
3400-300	Sterilization rolls		A13	5000-18	Articulators - spare parts - M5 screw - incisal table		K9	5033	Articulators - spare parts - fast caliper		K9	5112-4AL	Amalgam/wax carvers · P.K. Thomas	Alu80	K17	
3403-140	Sterilization pouches		A18	5000-24	Articulators - spare parts - rubber nubs		K7	5050	Articulators - average values		K2	5112-5	Amalgam/wax carvers · P.K. Thomas	Asa60	K17	
3403-75	Sterilization pouches		A18	5000-25	Articulators - spare parts - cast fastening washers		K7	5050Plus	Articulators - average values		K3	5112-5AL	Amalgam/wax carvers · P.K. Thomas	Alu80	K17	
3403-90	Sterilization pouches		A18	5000-26	Articulators - spare parts - magnet		K7	5050-2	Articulators - spare parts - support for occlusal table and template		K9	5113	Amalgam/wax carvers · Gritman		K16	
3400E-55	Sterilization rolls		A13	5000-30	Articulators - spare parts - magnet holder		K9	5050-3	Articulators - spare parts - incisal guide rod		K9	5114	Amalgam/wax carvers · Beale		K16	
3400E-75	Sterilization rolls		A13	5001	Articulators - occlusor		K6	5050-4	Articulators - spare parts - knurled knob for template and occlusal table		K9	5114-1	Periosteals and Elevators · Beale	Octagonal	E22	
3400E-100	Sterilization rolls		A13	5002	Articulators - average values		K6	5050-6	Articulators - spare parts - locking knob		K9	5115	Amalgam/wax carvers · Roach		K16	
3400E-150	Sterilization rolls		A13	5010-10	Articulators - spare parts - bearing rod		K9	5050-8	Articulators - spare parts - incisal pin		K9	5116	Amalgam/wax carvers · Vehe		K16	
3400E-200	Sterilization rolls		A13	5011-4	Articulators - spare parts - incisal guide table (0°)		K9	5050-17	Articulators - spare parts - hinge rod		K9	5150	Ceramic sculpturing instruments		K21	
3400E-250	Sterilization rolls		A13	5011-6	Articulators - spare parts - locking knob		K9	5050-20	Articulators - spare parts - back rod support		K9	5150-1	Ceramic sculpturing instruments	Alu80	K21	
3450E-B	Surgical face masks		A14	5011-9	Articulators - spare parts - condylar guidance		K9	5050-21	Articulators - spare parts - back rod		K9	5150-2	Ceramic sculpturing instruments	Alu80	K21	
3450E-C	Surgical face masks		A14	5011-11	Articulators - spare parts - rubber cap		K9	5050-24	Articulators - spare parts - rubber nubs		K9	5150-3	Ceramic sculpturing instruments	Alu80	K21	
3450E-HC	Surgical face masks		A14	5011-16	Articulators - spare parts - inclined contrast table		K9	5051	Articulators - spare parts - occlusal table		K9	5151	Ceramic sculpturing instruments		K21	
3450E-HR	Surgical face masks		A14	5011-17	Articulators - spare parts - hinge rod		K9	5052	Articulators - spare parts - template		K9	5151-1	Ceramic sculpturing instruments · Greenstein	Alu80	K21	
3450E-R	Surgical face masks		A14	5011-18	Articulators - spare parts - hinge rod washer		K9	5053	Articulators - spare parts - magnetic rod kit		K9	5151-2	Ceramic sculpturing instruments · Greenstein	Alu80	K21	
3450E-V	Surgical face masks		A14									5151-3	Ceramic sculpturing instruments · Greenstein	Alu80	K21	
3510-B	Napkins - AsaRainbow		A6									5153-1	Composite instruments · Asa Com 7/7B	Asa60	F49	
3510-BX	Napkins - AsaRainbow		A6									5155-1	Ceramic sculpturing instruments		K21	
3510-C	Napkins - AsaRainbow		A6													
3510-D	Napkins - AsaRainbow		A6													
3510-G	Napkins - AsaRainbow		A6													
3510-L	Napkins - AsaRainbow		A6													
3510-LI	Napkins - AsaRainbow		A6													
3510-NI	Napkins - AsaRainbow		A6													
3510-O	Napkins - AsaRainbow		A6													
3510-P	Napkins - AsaRainbow		A6													
3510-PE	Napkins - AsaRainbow		A6													
3510-V	Napkins - AsaRainbow		A6													
3511-B	Napkins - AsaRainbow		A6													
3511-BX	Napkins - AsaRainbow		A6													
3511-C	Napkins - AsaRainbow		A6													
3511-D	Napkins - AsaRainbow		A6													
3511-G	Napkins - AsaRainbow		A6													
3511-L	Napkins - AsaRainbow		A7													
3511-LI	Napkins - AsaRainbow		A7													
3511-N	Napkins - AsaRainbow		A7													
3511-O	Napkins - AsaRainbow		A7													
3511-P	Napkins - AsaRainbow		A7													
3511-PE	Napkins - AsaRainbow		A7													
3511-V	Napkins - AsaRainbow		A7													

code	description	handle	page	code	description	handle	page	code	description	handle	page	code	description	handle	page
5155-2	Ceramic sculpturing instruments		K21	5600-2	Crown scissors · curved, one blade serrated		F45 K28	5868	Wire forming pliers · long rounded jaws pliers		H19	8001	Instruments protective lubricant · Steril Oil		G33
5155-3	Ceramic sculpturing instruments		K21	5601-1	Crown scissors · straight		F45 K28	5869-1	Wire forming pliers · mini · Aderer		H21	8002	Instruments protective lubricant · Steril Oil		D71 I12
5156-1	Ceramic sculpturing instruments		K21	5601-2	Crown scissors · curved		F45 K28	5869-2	Wire forming pliers · standard · Aderer		H21	8010	Instruments protective lubricant · Silicone		D71 I12
5156-2	Ceramic sculpturing instruments		K21	5700	Wire scissors · straight, one blade serrated · universal		F45 K28	5870	Wire forming pliers · loop universal pliers · Tweed		H14	8020	AsaClean · PH neutral solution to facilitate removal of alginate		J40
5156-3	Ceramic sculpturing instruments		K21	5700TC	Wire scissors · TC universal		F45	5871	Wire forming pliers · lighth bird beak pliers		H24	8801-1	Wire forming pliers · universal pliers · Delphin		H10
5160-1	Ceramic sculpturing instruments (tips)		K18	5800	Wire forming pliers · Nance		H12	5872-1	Wire forming pliers · Tweed (Angle)		H15	8801-2	Wire forming pliers · universal pliers		H10
5160-2	Ceramic sculpturing instruments (tips)		K18	5801-1	Wire forming pliers · Delphin universal		H10	5874-1	Wire forming pliers · universal pliers · How		H23	8802	Wire forming pliers · Waldsachs		H11
5160-3	Ceramic sculpturing instruments (tips)		K18	5801-3	Wire forming pliers · universal		H10	5874-2	Wire forming pliers · curved · How		H23	8803	Wire forming pliers · optical pliers		H26
5200-1	Wax knives · Fahnenstock		K22	5802	Wire forming pliers · Waldsachs		H11	5875-1	Wire forming pliers · flat bending pliers		H24	8804-1	Wire forming pliers · loop universal pliers · Tweed		H14
5200-2	Wax knives · Fahnenstock		K22	5806	Wire forming pliers · round-concave		H12	5875-2	Wire forming pliers · flat knurled bending pliers		H24	8804-2	Wire forming pliers · omega loop pliers · Tweed		H13
5201-1	Wax knives · Lessmann		K22	5809-1	Wire forming pliers · loop pliers · Tweed		H12	5876-1	Wire forming pliers · knurled bending pliers		H24	8804-2P	Wire forming pliers		H13
5201-2	Wax knives · Lessmann		K22	5809-2	Wire forming pliers · omega loop pliers · Tweed		H13	5876-2	Wire forming pliers · bending pliers		H24	8804-3P	Wire forming pliers		H13
5202-1	Wax knives		K22	5809-3	Wire forming pliers · loop pliers · Tweed		H15	5880-1	Cutters · wire cutter <= 0.9 mm		H8	8805	Wire forming pliers · Reynolds		H16
5202-2	Wax knives		K22	5812	Wire forming pliers · Reynolds		H16	5880-2	Cutters · wire cutter <= 1.5 mm		H8	8806	Wire forming pliers · hollow chop pliers		H26
5300-1	Plaster knives		K23	5818	Wire forming pliers · lingual arch pliers		H16	5880-3TC	Cutters · wire cutter <= 1.2 mm		H9	8807-1	Wire forming pliers · mini arch bending pliers		H17
5300-2	Plaster knives · Gritman		K23	5819	Utility pliers · Weingart		H29	5900	Plaster cutting pliers · Asa Special Inox		K31	8807-2	Wire forming pliers · arch bending pliers		H17
5300-3	Plaster knives		K23	5821-1	Wire forming pliers · grooved pliers · De La Rosa		H18	6000	Mallets		K31	8807-3	Wire forming pliers · lingual arch pliers		H16
5300-4	Plaster knives		K23	5821-2	Wire forming pliers · non-grooved pliers · De La Rosa		H18	6001	Mallets		K31	8808-1	Utility pliers · Weingart		H29
5400-1	Rigid spatulas for plaster, alginate and elastomers		K24	5824-1	Utility pliers · wide bracket removing pliers		H31	6002	Mallets		K31	8808-2	Utility pliers · slim · Weingart		H29
5400-2	Rigid spatulas for plaster, alginate and elastomers		K24	5825	Utility pliers · angled bracket removing pliers		H32	6200	Fret saw		K33	8809	Utility pliers · wide bracket removing pliers		H31
5400-3	Rigid spatulas for plaster, alginate and elastomers		K24	5826-1	Utility pliers · wide beak removing pliers		H30	6201-1	Fret saw blades · for plaster		K33	8810	Utility pliers · angled bracket removing pliers		H32
5400-4	Flexible spatulas for plaster, alginate and elastomers		K25	5826-2	Utility pliers · narrow beak removing pliers		H30	6201-2	Fret saw blades · for metal		K33	8811-1	Utility pliers · short posterior band remover		H30
5400-5	Flexible spatulas for plaster, alginate and elastomers		K25	5826-CR1	Utility pliers		H30	6300	Saw for models		K33	8811-1P	Utility pliers		H30
5400-6	Flexible spatulas for plaster, alginate and elastomers		K25	5826-CR2	Utility pliers		H30	6301-1	Fret saw blades · for models		K33	8811-2	Utility pliers · long posterior band remover		H31
5400-7	Flexible spatulas for plaster, alginate and elastomers		K25	5828-1	Utility pliers · short posterior band remover		H30	6301-2	Fret saw blades · for models		K33	8812-1TC	Cutters · multi-use wire cutter		H7
5400-8	Rigid spatulas for plaster, alginate and elastomers		K24	5828-2	Utility pliers · long posterior band remover		H31	6301-3	Fret saw blades · for models		K33	8812-2TC	Cutters · hard wire cutter 15°		H4
5400-9	Rigid spatulas for plaster, alginate and elastomers		K24	5832	Cutters · multi-use wire cutter		H7	6400-1	Laboratory tweezers		K19	8813-1TC	Cutters · universal distal-end-cutter no hold		H4
5401-B	Spatulas for plaster and alginate		K26	5832-1TC	Cutters · multi-use wire cutter		H7	6400-2	Laboratory tweezers		K19	8814-1TC	Cutters · universal distal-end cutter		H5
5401-C	Spatulas for plaster and alginate		K26	5833	Cutters · micro-miniature wire cutter		H8	6600-2	Crucible tongs		K32	8815	Wire forming pliers · Johnson		H20
5401-F	Spatulas for plaster and alginate		K26	5833-1TC	Cutters · micro-miniature wire cutter		H8	6600-4	Crucible tongs		K32	8816	Wire forming pliers · precision pliers · Nance		H11
5401-G	Spatulas for plaster and alginate		K26	5836	Cutters · distal end cutter		H9	6600-5	Crucible tongs		K32	8817	Wire forming pliers · loop pliers · Young		H14
5401-R	Spatulas for plaster and alginate		K26	5836-1TC	Cutters · distal end cutter		H9	6900E-A	Ortho/prothesis boxes · Blue		H37	8818	Wire forming pliers · universal bird beak pliers		H22
5401-V	Spatulas for plaster and alginate		K26	5837	Cutters · micro distal end cutter		H9	6900E-B	Ortho/prothesis boxes · Blue		H37 K27	8819	Wire forming pliers · Adams		H20
5500-10	Mixing bowls for plaster and alginate		K26	5838	Wire forming pliers · with cutter · Angle		H19	6900E-B	Ortho/prothesis boxes · White		H37 K27	8820-1	Wire forming pliers · mini · Aderer		H21
5500-12	Mixing bowls for plaster and alginate		K26	5860-1	Wire forming pliers · Mc Kellops		H18	6900E-C	Ortho/prothesis boxes · Light blue		H37 K27	8820-2	Wire forming pliers · standard · Aderer		H21
5500-14	Mixing bowls for plaster and alginate		K26	5861	Wire forming pliers · Johnson		H20	6900E-C	Ortho/prothesis boxes · Light blue		H37 K27	8821	Wire forming pliers · bird beak pliers		H22
5500-16	Mixing bowls for plaster and alginate		K26	5862	Wire forming pliers · loop pliers · Nance		H15	7000-6	Ceramic sculpturing brushes		K20	8822-1	Wire forming pliers · universal pliers · How		H23
5501-10	Mixing bowls for plaster and alginate		K26	5863	Wire forming pliers · Young		H14	7000-7	Ceramic sculpturing brushes		K20	8822-2	Wire forming pliers · curved · How		H23
5501-12	Mixing bowls for plaster and alginate		K26	5864	Wire forming pliers · flat bending pliers		H18	7000-8	Ceramic sculpturing brushes		K20	8823	Wire forming pliers · Schwarz		H25
5501-14	Mixing bowls for plaster and alginate		K26	5865	Wire forming pliers · short rounded jaws pliers		H19	7001-0	Ceramic sculpturing brushes		K20	8824-1TC	Cutters · mini ligatures cutter		H6
5501-16	Mixing bowls for plaster and alginate		K26	5866	Wire forming pliers · Angle		H19	7001-00	Ceramic sculpturing brushes		K20	8825	Wire forming pliers · hammerhead NiTi pliers		H25
5600-1	Crown scissors · straight, one blade serrated		F45 K28	5867-1	Wire forming pliers · Adams		H20	7001-1	Ceramic sculpturing brushes		K20				
				5867-2	Wire forming pliers · Adams		H20	7001-3	Ceramic sculpturing brushes		K20				
								7002-4	Ceramic sculpturing brushes		K20				
								7002-6	Ceramic sculpturing brushes		K20				
								7002-8	Ceramic sculpturing brushes		K20				
								8000	"Lab Set" for Laboratory		K34				

code	description	handle	page	code	description	handle	page	code	description	handle	page	code	description	handle	page	
8826-1TC	Cutters · distal end flush cutter		H5	AL2724-2	Aluminum containers for instrument trays		I13	AL2760-2	Burs holder · aluminum, suitable for steam sterilizing - with rim, 24 holes CA		E34 I17	LV1807-06MF	Gracey curettes - MF · Gracey	Leonardo Light LV	G13	
8827-1TC	Cutters · micro ligatures cutter 15°		H6	AL2724-3	Aluminum containers for instrument trays		I13	AL2760-3	Burs holder · aluminum, suitable for steam sterilizing - with rim, 24 holes FG/CA		E34 I17	LV1807-08	Gracey curettes · Gracey	Leonardo Light LV	G11	
8828-1TC	Utility pliers · universal band splitter		H33	AL2724-4	Aluminum containers for instrument trays		I13	AL2760-U	Burs holder · lid		I17	LV1807-08AF	Gracey curettes - AF · Gracey	Leonardo Light LV	G12	
8829	Wire forming pliers · Jarabak		H27	AL2725	Endodontic articles		I16	AL2761-1	Burs holder · with rim, 36 holes FG		I17	LV1807-08MF	Gracey curettes - MF · Gracey	Leonardo Light LV	G13	
8830	Wire forming pliers · V-stop		H27	AL2727-1	Plastic trays		A10	AL2761-2	Burs holder · with rim, 36 holes CA		I17	LV1807-10	Gracey curettes · Gracey	Leonardo Light LV	G11	
8831	Utility pliers · adhesive removing pliers		H32	AL2727-1AZ	Plastic trays		A10	AL2761-3	Burs holder · with rim, 36 holes FG/CA		I17	LV1807-11MD	Gracey curettes · Gracey	Leonardo Light LV	G11	
8831-1P	Utility pliers		H32	AL2727-1CZ	Plastic trays		A10	AL2761-U	Burs holder · lid		E34 I17	LV1807-12	Gracey curettes · Gracey	Leonardo Light LV	G11	
8832	Bracket placement marker		H36	AL2727-1GZ	Plastic trays		A10	AL2762-1	Burs holder · aluminum, suitable for steam sterilizing - 48 holes FG		I17	LV1807-12AF	Gracey curettes - AF · Gracey	Leonardo Light LV	G12	
9002	Case for instruments and pliers		D71	AL2727-1OZ	Plastic trays		A10	AL2762-2	Burs holder · aluminum, suitable for steam sterilizing - 48 holes CA		E34 I17	LV1807-12MF	Gracey curettes - MF · Gracey	Leonardo Light LV	G13	
9002-1	Insert for 6 extractive forceps		D71	AL2727-1Z	Plastic trays		A10	AL2762-3	Burs holder · aluminum, suitable for steam sterilizing - 48 holes FG/CA		I17	LV1807-13MD	Gracey curettes · Gracey	Leonardo Light LV	G11	
9002-2	Insert with elastic bands for 10 instruments		D71	AL2727-2	Plastic trays		A11	AL2763-1	Burs holder · with 7 bur holders, with lid		I17	LV1807-14	Gracey curettes · Gracey	Leonardo Light LV	G11	
9002-3	Insert with slots for 16 instruments		D71	AL2727-2AZ	Plastic trays		A11	AL2763-2	Burs holder · with 2 bur holders		I17	LV1807-14AF	Gracey curettes - AF · Gracey	Leonardo Light LV	G12	
AL2720-LA	Aluminum colour-coded instrument trays · Silver		I8	AL2727-2CZ	Plastic trays		A11	AL2764-A	Accessories · aluminum waste container		I18	LV1807-14MF	Gracey curettes - MF · Gracey	Leonardo Light LV	G13	
AL2720-LC	Aluminum colour-coded instrument trays · Light blue		I8	AL2727-2GZ	Plastic trays		A11	AL2764-C	Accessories · aluminum waste container		I18	LV1807-16	Gracey curettes · Gracey	Leonardo Light LV	G11	
AL2720-LO	Aluminum colour-coded instrument trays · Gold		I8	AL2727-2OZ	Plastic trays		A11	AL2764-O	Accessories · aluminum waste container		I18	LV1807-16AF	Gracey curettes - AF · Gracey	Leonardo Light LV	G12	
AL2720-LR	Aluminum colour-coded instrument trays · Red		I8	AL2727-2Z	Plastic trays		A11	AL2764-R	Accessories · aluminum waste container		I18	LV1807-16MF	Gracey curettes - MF · Gracey	Leonardo Light LV	G13	
AL2720-LV	Aluminum colour-coded instrument trays · Green		I8	AL2730-1	Aluminum insert frames · for 11 instruments		I8	AL2764-V	Accessories · aluminum waste container		I18	LV1807-18	Gracey curettes · Gracey	Leonardo Light LV	G11	
AL2720-UA	Aluminum colour-coded instrument trays · Silver		I8	AL2730-2	Aluminum insert frames · for 17 instruments		I8	AL2765-A	Accessories · aluminum cotton dispensers		I18	LV1826-T03	Curettes and Scalers · Taylor	Leonardo Light LV	G8	
AL2721-LA	Aluminum colour-coded instrument trays - perforated · Silver		I9	AL2730-3	Aluminum insert frames · for 10 instruments		I9	AL2765-C	Accessories · aluminum cotton dispensers		I18	LV1827-204S	Curettes and Scalers	Leonardo Light LV	G8	
AL2721-LC	Aluminum colour-coded instrument trays - perforated · Light blue		I9	AL2730-4	Aluminum insert frames · for 11 instruments		I9	AL2765-O	Accessories · aluminum cotton dispensers		I18	LV1829-CK6	Curettes and Scalers · Crane-Kaplan	Leonardo Light LV	G8	
AL2721-LO	Aluminum colour-coded instrument trays - perforated · Gold		I9	AL2731-1	Aluminum insert frames · for 8 instruments		I11	AL2765-R	Accessories · aluminum cotton dispensers		I18	MB026-1	Stainless steel compass		J19	
AL2721-LR	Aluminum colour-coded instrument trays - perforated · Red		I9	AL2731-2	Aluminum insert frames · for 4 instruments		I11	AL2766	Accessories · plastic box for used needles		A21 I19	MC0700-23	Single ended Explorers	Magic Color MC	B6	
AL2721-LV	Aluminum colour-coded instrument trays - perforated · Green		I9	AL2735	Mixing trays		A21	AL2767-1	Accessories · waste containers		A22 I18 I18	MC0700-6	Single ended Explorers	Magic Color MC	B6	
AL2721-UA	Aluminum colour-coded instrument trays - perforated · Silver		I9	AL2736	Plastic mixing spatulas		A21	AL2767-2	Accessories · aluminium base for waste container		A22 I18	MC0700-9	Single ended Explorers	Magic Color MC	B6	
AL2722-LA	Aluminum colour-coded instrument trays · Silver		I10	AL2738-1	Plastic trays		A11	LV1807-02	Gracey curettes · Gracey	Leonardo Light LV	G11	MC0702-12	Periodontal pocket Probes	Magic Color MC	E32 G3	
AL2722-LC	Aluminum colour-coded instrument trays · Light blue		I10	AL2738-2	Plastic trays		A11	LV1807-02AF	Gracey curettes - AF · Gracey	Leonardo Light LV	G12	MC0702-OMS	Periodontal pocket Probes	Magic Color MC	G3	
AL2722-LO	Aluminum colour-coded instrument trays · Gold		I10	AL2739-1	Aluminum instrument tray rack · 6 compartments		I13	LV1807-02MF	Gracey curettes - MF · Gracey	Leonardo Light LV	G13	MC0703-14	Periodontal pocket Probes	Magic Color MC	G3	
AL2722-LR	Aluminum colour-coded instrument trays · Red		I10	AL2739-2	Aluminum instrument tray rack · 6 compartments		I13	LV1807-04	Gracey curettes · Gracey	Leonardo Light LV	G11	MC0704-11/12AF	Double ended Explorers	Magic Color MC	B8	
AL2722-LV	Aluminum colour-coded instrument trays · Green		I10	AL2740-1	Endodontic boxes		I14	LV1807-04AF	Gracey curettes - AF · Gracey	Leonardo Light LV	G12	MC0704-23D1	Double ended Explorers	Magic Color MC	B8	
AL2722-UA	Aluminum colour-coded instrument trays · Silver		I10	AL2740-2	Endodontic boxes		I14	LV1807-04MF	Gracey curettes - MF · Gracey	Leonardo Light LV	G13	MC0704-6D9	Double ended Explorers	Magic Color MC	B8	
AL2723-LA	Aluminum colour-coded instrument trays · Silver		I11	AL2740-3	Endodontic boxes		I14	LV1807-06	Gracey curettes · Gracey	Leonardo Light LV	G11	MC0707-GFW	Combination Explorers - Probes · Goldman-Fox Williams	Magic Color MC	B11	
AL2723-LC	Aluminum colour-coded instrument trays · Light blue		I11	AL2740-4	Endodontic boxes		I14	LV1807-06AF	Gracey curettes - AF · Gracey	Leonardo Light LV	G12	MC0708-2N	Double ended Explorers · Nabers	Magic Color MC	B11	
AL2723-LO	Aluminum colour-coded instrument trays · Gold		I11	AL2740-5	Endodontic boxes		I14									
AL2723-LR	Aluminum colour-coded instrument trays · Red		I11	AL2740-R	Endodontic boxes		I15									
AL2723-LV	Aluminum colour-coded instrument trays · Green		I11	AL2741-1	Endodontic boxes		I14									
AL2723-UA	Aluminum colour-coded instrument trays · Silver		I11	AL2741-2	Endodontic boxes		I14									
AL2724-1	Aluminum containers for instrument trays		I13	AL2742-1	Endodontic boxes		I15									
				AL2742-2	Endodontic boxes		I15									
				AL2742-3	Endodontic boxes		I15									
				AL2742-4	Endodontic boxes		I15									
				AL2742-5	Endodontic boxes		I15									
				AL2742-6	Endodontic boxes		I15									
				AL2742-7	Endodontic boxes		I15									
				AL2743	Endodontic boxes		I15									
				AL2744	Endodontic boxes		I15									
				AL2745-1A	Endodontic articles		I16									
				AL2745-2C	Endodontic articles		I16									
				AL2746-1	Endodontic articles		I16									
				AL2746-2	Endodontic articles		I16									
				AL2747-1A	Endodontic articles		I16									
				AL2760-1	Burs holder · with rim, 24 holes FG		I17									

code	description	handle	page	code	description	handle	page	code	description	handle	page	code	description	handle	page		
MC0800-1	Root-canal Spreaders	Magic Color MC	B12	MC1806-4RL	Curettes and Scalers · Columbia	Magic Color MC	G4	ML0704-6D9	Double ended Explorers	Leonardo ML	B8	ML1807-11MD	Gracey curettes · Gracey	Leonardo ML	G11		
MC0800-2	Root-canal Spreaders	Magic Color MC	B12	MC1807-02	Gracey curettes · Gracey	Magic Color MC	G11	ML0705-23W	Combination Explorers - Probes · Williams	Leonardo ML	B10	ML1807-12	Gracey curettes · Gracey	Leonardo ML	G11		
MC0800-3	Root-canal Spreaders	Magic Color MC	B12	MC1807-02MF	Gracey curettes - MF · Gracey	Magic Color MC	G13	ML0708-2N	Double ended Explorers · Nabers	Leonardo ML	B11	ML1807-12AF	Gracey curettes - AF · Gracey	Leonardo ML	G12		
MC0802-2	Root-canal Pluggers · Schilder	Magic Color MC	B14	MC1807-04	Gracey curettes · Gracey	Magic Color MC	G11	ML0800-1	Root-canal Spreaders	Leonardo ML	B12	ML1807-12MF	Gracey curettes - MF · Gracey	Leonardo ML	G13		
MC0802-4	Root-canal Pluggers · Schilder	Magic Color MC	B14	MC1807-04MF	Gracey curettes - MF · Gracey	Magic Color MC	G13	ML0800-2	Root-canal Spreaders	Leonardo ML	B12	ML1807-13MD	Gracey curettes · Gracey	Leonardo ML	G11		
MC0802-6	Root-canal Pluggers · Schilder	Magic Color MC	B14	MC1807-06	Gracey curettes · Gracey	Magic Color MC	G11	ML0800-3	Root-canal Spreaders	Leonardo ML	B12	ML1807-14	Gracey curettes · Gracey	Leonardo ML	G11		
MC0803-1	Root-canal Pluggers · Machtou	Magic Color MC	B13	MC1807-06MF	Gracey curettes - MF · Gracey	Magic Color MC	G13	ML0802-1	Root-canal Pluggers · Schilder	Leonardo ML	B14	ML1807-14AF	Gracey curettes - AF · Gracey	Leonardo ML	G12		
MC0803-2	Root-canal Pluggers · Machtou	Magic Color MC	B13	MC1807-08	Gracey curettes · Gracey	Magic Color MC	G11	ML0802-10	Root-canal Pluggers · Schilder	Leonardo ML	B14	ML1807-14MF	Gracey curettes - MF · Gracey	Leonardo ML	G13		
MC0803-3	Root-canal Pluggers · Machtou	Magic Color MC	B13	MC1807-08MF	Gracey curettes - MF · Gracey	Magic Color MC	G13	ML0802-2	Root-canal Pluggers · Schilder	Leonardo ML	B14	ML1807-16	Gracey curettes · Gracey	Leonardo ML	G11		
MC0803-4	Root-canal Pluggers · Machtou	Magic Color MC	B13	MC1807-10	Gracey curettes · Gracey	Magic Color MC	G11	ML0802-3	Root-canal Pluggers · Schilder	Leonardo ML	B14	ML1807-16AF	Gracey curettes - AF · Gracey	Leonardo ML	G12		
MC1102-1	Separating spatulas · Heidemann	Magic Color MC	F24	MC1807-12	Gracey curettes · Gracey	Magic Color MC	G11	ML0802-4	Root-canal Pluggers · Schilder	Leonardo ML	B14	ML1807-16MF	Gracey curettes - MF · Gracey	Leonardo ML	G13		
MC1102-2	Separating spatulas · Heidemann	Magic Color MC	F24	MC1807-12MF	Gracey curettes - MF · Gracey	Magic Color MC	G13	ML0802-5	Root-canal Pluggers · Schilder	Leonardo ML	B14	ML1807-18	Gracey curettes · Gracey	Leonardo ML	G11		
MC1202-2	Filling instruments - amalgam	Magic Color MC	F27	MC1807-14	Gracey curettes · Gracey	Magic Color MC	G11	ML0802-6	Root-canal Pluggers · Schilder	Leonardo ML	B14	ML1809-1	Curettes and Scalers · Goldman-Fox	Leonardo ML	G6		
MC1204-1	Filling instruments - Burnishers · Westcott	Magic Color MC	F31	MC1807-14MF	Gracey curettes - MF · Gracey	Magic Color MC	G13	ML0802-7	Root-canal Pluggers · Schilder	Leonardo ML	B14	ML1809-2	Curettes and Scalers · Goldman-Fox	Leonardo ML	G6		
MC1210-2	Filling instruments - plastic	Magic Color MC	F35	MC1807-16	Gracey curettes · Gracey	Magic Color MC	G11	ML0802-8	Root-canal Pluggers · Schilder	Leonardo ML	B14	ML1809-21	Curettes and Scalers · Goldman-Fox	Leonardo ML	G6		
MC1215-18	Filling instruments - Burnishers · Ball	Magic Color MC	F31	MC1807-16MF	Gracey curettes - MF · Gracey	Magic Color MC	G13	ML0802-9	Root-canal Pluggers · Schilder	Leonardo ML	B14	ML1809-3	Curettes and Scalers · Goldman-Fox	Leonardo ML	G6		
MC1215-27S	Filling instruments - Burnishers	Magic Color MC	F31	MC1807-18	Gracey curettes · Gracey	Magic Color MC	G11	ML0803-1	Root-canal Pluggers · Machtou	Leonardo ML	B13	ML1809-4	Curettes and Scalers · Goldman-Fox	Leonardo ML	G6		
MC1400-2	Filling instruments - amalgam · Markley	Magic Color MC	F29	MC1827-204S	Curettes and Scalers	Magic Color MC	G8	ML0803-2	Root-canal Pluggers · Machtou	Leonardo ML	B13	ML1809-5	Curettes and Scalers · Goldman-Fox	Leonardo ML	G6		
MC1500-02	Amalgam/wax carvers · Hollenback	Magic Color MC	F36 K13	MC1829-CK6S	Curettes and Scalers · Mini Crane-Kaplan	Magic Color MC	G8	ML0803-3	Root-canal Pluggers · Machtou	Leonardo ML	B13	ML1816-06	Gingivectomy knives · Buck	Leonardo ML	G24		
MC1510-1D	Composite instruments	Magic Color MC	F50	MC1902-1	Scalers · Towner Jacqueline	Magic Color MC	G14	ML0803-4	Root-canal Pluggers · Machtou	Leonardo ML	B13	ML1825-14S	Curettes and Scalers · Mc Call	Leonardo ML	G7		
MC1510-2D	Composite instruments	Magic Color MC	F50	MC2000-1	Bone curettes · Hemingway	Magic Color MC	C45 E21 G20	ML0804-1	Depth gauges		E32	ML1826-T03	Curettes and Scalers · Taylor	Leonardo ML	G8		
MC1510-3D	Composite instruments	Magic Color MC	F50	MC2000-2	Bone curettes · Hemingway	Magic Color MC	C45 E21 G20	ML1401-0	Filling instruments - amalgam · Foc	Leonardo ML	F30	ML1827-204S	Curettes and Scalers	Leonardo ML	G8		
MC1510-4D	Composite instruments	Magic Color MC	F50	MC2000-3	Bone curettes · Hemingway	Magic Color MC	C45 E21 G20	ML1401-0S	Filling instruments - amalgam · Foc	Leonardo ML	F30	ML1829-CK6	Curettes and Scalers · Crane-Kaplan	Leonardo ML	G8		
MC1510-5D	Composite instruments	Magic Color MC	F50	MC2101-B	Simple stem Mouth Mirrors - Handles	Magic Color MC	B19	ML1401-1	Filling instruments - amalgam · Foc	Leonardo ML	F30	ML1829-CK6S	Curettes and Scalers · Mini Crane-Kaplan	Leonardo ML	G8		
MC1600-1	Amalgam carvers · cleoid-discoid	Magic Color MC	F38	ML0700-17	Single ended Explorers	Leonardo ML	B6	ML1401-1S	Filling instruments - amalgam · Foc	Leonardo ML	F30	ML1830-YG08	Curettes and Scalers · Younger-Good	Leonardo ML	G8		
MC1700-1	Excavators - spoons	Magic Color MC	F13	ML0700-23	Single ended Explorers	Leonardo ML	B6	ML1401-2	Filling instruments - amalgam · Foc	Leonardo ML	F30	ML1845-1	Periotomes	Leonardo ML	D68 E29		
MC1700-2	Excavators - spoons	Magic Color MC	F13	ML0700-3R	Single ended Explorers · Rhein	Leonardo ML	B6	ML1401-2S	Filling instruments - amalgam · Foc	Leonardo ML	F30	ML1845-2	Periotomes	Leonardo ML	D68 E29		
MC1700-3	Excavators - spoons	Magic Color MC	F13	ML0700-6	Single ended Explorers	Leonardo ML	B6	ML1710-14	Excavators · SS. White	Leonardo ML	F16	ML1845-3	Periotomes	Leonardo ML	D68 E29		
MC1703-14	Excavators - spoons	Magic Color MC	F14	ML0700-8	Single ended Explorers	Leonardo ML	B6	ML1710-17	Excavators · SS. White	Leonardo ML	F16	ML1900-M23	Scalers · universal scaler	Leonardo ML	G14		
MC1704-17	Excavators - spoons	Magic Color MC	F14	ML0700-9	Single ended Explorers	Leonardo ML	B6	ML1710-18	Excavators · SS. White	Leonardo ML	F16	ML1902-1	Scalers · Towner Jacqueline	Leonardo ML	G14		
MC1806-14	Curettes and Scalers · Columbia	Magic Color MC	G4	ML0702-OMS	Periodontal pocket Probes · Novatech	Leonardo ML	G3	ML1710-19	Excavators · SS. White	Leonardo ML	F16	ML1903	Scalers · Towner	Leonardo ML	G14		
MC1806-2RL	Curettes and Scalers · Columbia	Magic Color MC	G4	ML0703-14	Periodontal pocket Probes · Williams	Leonardo ML	G3	ML1710-20	Excavators · SS. White	Leonardo ML	F16	ML1906-1	Scalers · Jacqueline	Leonardo ML	G15		
				ML0704-11/12AF	Double ended Explorers	Leonardo ML	B8	ML1710-5	Excavators · SS. White	Leonardo ML	F16	ML1906-2	Scalers · Jacqueline	Leonardo ML	G15		
				ML0704-23D1	Double ended Explorers	Leonardo ML	B8	ML1711-1	Excavators · Darby-Perry	Leonardo ML	F17	ML1906-3	Scalers · Jacqueline	Leonardo ML	G15		
				ML0704-6D2	Double ended Explorers	Leonardo ML	B9	ML1711-11	Excavators · Darby-Perry	Leonardo ML	F17	ML2000-1	Bone curettes · Hemingway	Leonardo ML	C45 E21 G20		
								ML1711-12	Excavators · Darby-Perry	Leonardo ML	F17	ML2000-2	Bone curettes · Hemingway	Leonardo ML	C45 E21 G20		
								ML1711-2	Excavators · Darby-Perry	Leonardo ML	F17	ML2000-3	Bone curettes · Hemingway	Leonardo ML	C45 E21 G20		
								ML1711-21	Excavators · Darby-Perry	Leonardo ML	F17	ML2000-4	Bone curettes · Hemingway	Leonardo ML	G20		
								ML1711-22	Excavators · Darby-Perry	Leonardo ML	F17	ML2001-85	Bone curettes · Lucas	Leonardo ML	G20		
								ML1711-243	Excavators - ASH	Leonardo ML	F15	ML2001-86	Bone curettes · Lucas	Leonardo ML	G20		
								ML1711-31	Excavators · Darby-Perry	Leonardo ML	F17	ML2001-87	Bone curettes · Lucas	Leonardo ML	G20		
								ML1711-32	Excavators · Darby-Perry	Leonardo ML	F17	ML2001-88	Bone curettes · Lucas	Leonardo ML	G20		
								ML1711-41	Excavators · Darby-Perry	Leonardo ML	F17	ML2101	Simple stem Mouth Mirrors - Handles	Leonardo ML	B19		
								ML1711-42	Excavators · Darby-Perry	Leonardo ML	F17	MV1851-PR3	Periosteals and Elevators · Prichard	Asa Light MV	E23 G16		
								ML1711-G2	Excavators - ASH	Leonardo ML	F15	MV2000-1	Bone curettes · Hemingway	Asa Light MV	C45 E21 G20		
								ML1803-D	Gingivectomy knives · Kirkland	Leonardo ML	G24	MV2000-2	Bone curettes · Hemingway	Asa Light MV	C45 E21 G20		
								ML1804-D	Gingivectomy knives · Orban	Leonardo ML	G24						
								ML1806-14	Curettes and Scalers · Columbia	Leonardo ML	G4						
								ML1806-4RL	Curettes and Scalers · Columbia	Leonardo ML	G4						
								ML1807-02	Gracey curettes · Gracey	Leonardo ML	G11						
								ML1807-02AF	Gracey curettes - AF · Gracey	Leonardo ML	G12						
								ML1807-02MF	Gracey curettes - MF · Gracey	Leonardo ML	G13						
								ML1807-04	Gracey curettes · Gracey	Leonardo ML	G11						
								ML1807-04AF	Gracey curettes - AF · Gracey	Leonardo ML	G12						
								ML1807-04MF	Gracey curettes - MF · Gracey	Leonardo ML	G13						
								ML1807-06	Gracey curettes · Gracey	Leonardo ML	G11						
								ML1807-06AF	Gracey curettes - AF · Gracey	Leonardo ML	G12						
								ML1807-06MF	Gracey curettes - MF · Gracey	Leonardo ML	G13						
								ML1807-08	Gracey curettes · Gracey	Leonardo ML	G11						
								ML1807-08AF	Gracey curettes - AF · Gracey	Leonardo ML	G12						
								ML1807-08MF	Gracey curettes - MF · Gracey	Leonardo ML	G13						
								ML1807-10	Gracey curettes · Gracey	Leonardo ML	G11						

code	description	handle	page	code	description	handle	page	code	description	handle	page	code	description	handle	page
MV2000-3	Bone curettes · Hemingway	Asa Light MV	C45 E21 G20	MV1204-1	Filling instruments - Burnishers · Westcott	Asa Light MV	F31	MV1400-1	Filling instruments - amalgam · Markley	Asa Light MV	F29	MV1704-17	Excavators - spoons	Asa Light MV	F14
MV0704-16D1	Double ended Explorers	Asa Light MV	B8	MV1204-2	Filling instruments - Burnishers · Westcott	Asa Light MV	F31	MV1400-2	Filling instruments - amalgam · Markley	Asa Light MV	F29	MV1704-17W	Excavators - oval spoons	Asa Light MV	F15
MV0704-16D2	Double ended Explorers	Asa Light MV	B8	MV1205-1	Filling instruments - amalgam · Ward	Asa Light MV	F28	MV1400-3	Filling instruments - amalgam · Markley	Asa Light MV	F29	MV1705-18	Excavators - spoons	Asa Light MV	F14
MV0704-23D1	Double ended Explorers	Asa Light MV	B8	MV1205-2	Filling instruments - amalgam · Ward	Asa Light MV	F28	MV1400-4	Filling instruments - amalgam · Markley	Asa Light MV	F29	MV1705-18W	Excavators - oval spoons	Asa Light MV	F15
MV0704-23D2	Double ended Explorers	Asa Light MV	B8	MV1206-1	Filling instruments - plastic	Asa Light MV	F34	MV1400-5	Filling instruments - amalgam · Markley	Asa Light MV	F29	MV1706-19	Excavators - spoons	Asa Light MV	F14
MV0704-UT1	Double ended Explorers · Cattoni	Asa Light MV	B8	MV1206-2	Filling instruments - plastic	Asa Light MV	F34	MV1400-6	Filling instruments - amalgam · Markley	Asa Light MV	F29	MV1706-19W	Excavators - oval spoons	Asa Light MV	F15
MV0705-16GF	Combination Explorers - Probes · Goldman-Fox	Asa Light MV	B10	MV1207-1	Filling instruments - plastic	Asa Light MV	F34	MV1500-02	Amalgam/wax carvers · Hollenback	Asa Light MV	F36 K13	MV1707-39	Excavators - spoons	Asa Light MV	B15 F14
MV0705-16W	Combination Explorers - Probes · Williams	Asa Light MV	B10	MV1207-2	Filling instruments - plastic	Asa Light MV	F34	MV1500-3	Amalgam/wax carvers · Hollenback	Asa Light MV	F36 K13	MV1709-31L	Excavators - spoons	Asa Light MV	B15 F14
MV0705-17GF	Combination Explorers - Probes · Goldman-Fox	Asa Light MV	B10	MV1208-1	Filling instruments - plastic	Asa Light MV	F34	MV1500-3S	Amalgam/wax carvers · Hollenback	Asa Light MV	F36 K13	MV1709-32L	Excavators - spoons	Asa Light MV	B15 F14
MV0705-17UM	Combination Explorers - Probes · University of Michigan	Asa Light MV	B10	MV1208-2	Filling instruments - plastic	Asa Light MV	F34	MV1501-1	Amalgam/wax carvers · Ward	Asa Light MV	F36 K13	MV1709-33L	Excavators - spoons	Asa Light MV	B15 F14
MV0705-17W	Combination Explorers - Probes · Williams	Asa Light MV	B11	MV1208-3	Filling instruments - plastic	Asa Light MV	F34	MV1501-1S	Amalgam/wax carvers · Ward	Asa Light MV	F36 K13	MV1801-D	Chisels · TG	Asa Light MV	G26
MV0705-23GF	Combination Explorers - Probes · Goldman-Fox	Asa Light MV	B10	MV1209-1	Filling instruments - plastic	Asa Light MV	F34	MV1501-15	Amalgam/wax carvers · Ward	Asa Light MV	F36 K13	MV1802-3	Chisels · Ochsenbein	Asa Light MV	G26
MV0705-23UM	Combination Explorers - Probes · University of Michigan	Asa Light MV	B10	MV1209-2	Filling instruments - plastic	Asa Light MV	F34	MV1501-2	Amalgam/wax carvers · Ward	Asa Light MV	F36 K13	MV1802-4	Chisels · Ochsenbein	Asa Light MV	G26
MV0705-23W	Combination Explorers - Probes · Williams	Asa Light MV	B10	MV1209-3	Filling instruments - plastic	Asa Light MV	F34	MV1502-1	Amalgam/wax carvers · Frahm	Asa Light MV	F36 K13	MV1803-D	Gingivectomy knives · Kirkland	Asa Light MV	G24
MV0705-3GF	Root-canal Explorers · Goldman-Fox	Asa Light MV	B10	MV1210-1	Filling instruments - plastic	Asa Light MV	F35	MV1507-8	Amalgam carvers	Asa Light MV	F37	MV1804-D	Gingivectomy knives · Orban	Asa Light MV	G24
MV0706-2311	Combination Explorers - Probes	Asa Light MV	B10	MV1210-2	Filling instruments - plastic	Asa Light MV	F35	MV1600-1	Amalgam carvers · cleoid-discoid	Asa Light MV	F38	MV1805-02	Curettes and Scalers · Langer	Asa Light MV	G5
MV0706-2312	Combination Explorers - Probes	Asa Light MV	B11	MV1210-3	Filling instruments - plastic	Asa Light MV	F35	MV1600-2	Amalgam carvers · cleoid-discoid	Asa Light MV	F38	MV1805-04	Curettes and Scalers · Langer	Asa Light MV	G5
MV0707-GFW	Combination Explorers - Probes · Goldman-Fox Williams	Asa Light MV	B11	MV1211-0T	Filling instruments - amalgam · Tanner	Asa Light MV	F28	MV1600-3	Amalgam carvers · cleoid-discoid	Asa Light MV	F38	MV1806-02	Curettes and Scalers	Asa Light MV	G4
MV0708-1N	Double ended Explorers · Nabers	Asa Light MV	B11	MV1211-1T	Filling instruments - amalgam · Tanner	Asa Light MV	F28	MV1600-4	Amalgam carvers · cleoid-discoid	Asa Light MV	F38	MV1806-14	Curettes and Scalers · Columbia	Asa Light MV	G4
MV0708-2N	Double ended Explorers · Nabers	Asa Light MV	B11	MV1211-2T	Filling instruments - amalgam · Tanner	Asa Light MV	F28	MV1601-1	Cavity preparation instruments - margin trimmers · distal · Black/26	Asa Light MV	F18	MV1806-2RL	Curettes and Scalers · Columbia	Asa Light MV	G4
MV0709-2	Double ended Explorers	Asa Light MV	B8	MV1211-3T	Filling instruments - amalgam · Tanner	Asa Light MV	F28	MV1601-2	Cavity preparation instruments - margin trimmers · mesial · Black/27	Asa Light MV	F19	MV1806-412	Curettes and Scalers · Columbia	Asa Light MV	G4
MV0709-2A	Double ended Explorers	Asa Light MV	B8	MV1212-01	Filling instruments - amalgam · Marquette	Asa Light MV	F28	MV1601-3	Cavity preparation instruments - margin trimmers · distal · Black/28	Asa Light MV	F19	MV1806-414	Curettes and Scalers · Columbia	Asa Light MV	G4
MV0709-3	Double ended Explorers	Asa Light MV	B9	MV1212-H1	Filling instruments - amalgam · Hollenback	Asa Light MV	F28	MV1601-4	Cavity preparation instruments - margin trimmers · mesial · Black/29	Asa Light MV	F19	MV1806-4RL	Curettes and Scalers · Columbia	Asa Light MV	G4
MV0710-6D1	Root-canal Explorers	Asa Light MV	B9	MV1212-H2	Filling instruments - amalgam · Hollenback	Asa Light MV	F28	MV1602-1	Cavity preparation instruments - margin trimmers · distal · Black/77-78	Asa Light MV	F19	MV1807-02	Gracey curettes · Gracey	Asa Light MV	G11
MV0710-6D2	Root-canal Explorers	Asa Light MV	B9	MV1212-H3	Filling instruments - amalgam · Hollenback	Asa Light MV	F28	MV1602-2	Cavity preparation instruments - margin trimmers · mesial · Black/79-80	Asa Light MV	F19	MV1807-04	Gracey curettes · Gracey	Asa Light MV	G11
MV0710-6D3	Root-canal Explorers	Asa Light MV	B9	MV1212-H4	Filling instruments - amalgam · Hollenback	Asa Light MV	F28	MV1603-1	Cavity preparation instruments - hatchets · Black/53-54	Asa Light MV	F18	MV1807-06	Gracey curettes · Gracey	Asa Light MV	G11
MV1102-1	Separating spatulas · Heidemann	Asa Light MV	F24	MV1213-H1	Filling instruments - amalgam · Hollenback	Asa Light MV	F28	MV1603-2	Cavity preparation instruments - hatchets · Black/51-52	Asa Light MV	F18	MV1807-08	Gracey curettes · Gracey	Asa Light MV	G11
MV1102-2	Separating spatulas · Heidemann	Asa Light MV	F24	MV1213-H2	Filling instruments - amalgam · Hollenback	Asa Light MV	F28	MV1604-02	Cavity preparation instruments - chisels · Wedelstaet	Asa Light MV	F18	MV1807-10	Gracey curettes · Gracey	Asa Light MV	G11
MV1102-3	Separating spatulas · Heidemann	Asa Light MV	F24	MV1213-H3	Filling instruments - amalgam · Hollenback	Asa Light MV	F28	MV1604-04	Cavity preparation instruments - chisels · Wedelstaet	Asa Light MV	F18	MV1807-11MD	Gracey curettes · Gracey	Asa Light MV	G11
MV1200-1	Filling instruments - amalgam	Asa Light MV	F26	MV1213-H4	Filling instruments - amalgam · Hollenback	Asa Light MV	F28	MV1604-06	Cavity preparation instruments - chisels · Wedelstaet	Asa Light MV	F18	MV1807-12	Gracey curettes · Gracey	Asa Light MV	G11
MV1200-2	Filling instruments - amalgam	Asa Light MV	F26	MV1214-2	Filling instruments - Burnishers · Ladmore	Asa Light MV	F31	MV1700-0	Excavators - spoons	Asa Light MV	F13	MV1807-13MD	Gracey curettes · Gracey	Asa Light MV	G11
MV1200-3	Filling instruments - amalgam	Asa Light MV	F26	MV1214-3	Filling instruments - Burnishers · Ladmore	Asa Light MV	F31	MV1700-1	Excavators - spoons	Asa Light MV	F13	MV1807-14	Gracey curettes · Gracey	Asa Light MV	G11
MV1200-4	Filling instruments - amalgam	Asa Light MV	F26	MV1215-18	Filling instruments - Burnishers · Ball	Asa Light MV	F31	MV1700-2	Excavators - spoons	Asa Light MV	F13	MV1809-1	Curettes and Scalers · Goldman-Fox	Asa Light MV	G6
MV1200-5	Filling instruments - amalgam	Asa Light MV	F26	MV1215-27S	Filling instruments - Burnishers · Ball	Asa Light MV	F31	MV1700-3	Excavators - spoons	Asa Light MV	F13	MV1809-2	Curettes and Scalers · Goldman-Fox	Asa Light MV	G6
MV1201-1	Filling instruments - amalgam	Asa Light MV	F26	MV1215-29	Filling instruments - Burnishers · Ball	Asa Light MV	F31	MV1700-4	Excavators - spoons	Asa Light MV	F13	MV1809-21	Curettes and Scalers · Goldman-Fox	Asa Light MV	G6
MV1201-1L	Filling instruments - amalgam	Asa Light MV	F26	MV1216-1	Filling instruments - plastic · Woodson	Asa Light MV	F35	MV1701-1	Excavators - spoons	Asa Light MV	F13	MV1809-3	Curettes and Scalers · Goldman-Fox	Asa Light MV	G6
MV1201-2	Filling instruments - amalgam	Asa Light MV	F26	MV1216-2	Filling instruments - plastic · Woodson	Asa Light MV	F35	MV1701-2	Excavators - spoons	Asa Light MV	F13	MV1809-4	Curettes and Scalers · Goldman-Fox	Asa Light MV	G6
MV1201-2L	Filling instruments - amalgam	Asa Light MV	F26	MV1216-3	Filling instruments - plastic · Woodson	Asa Light MV	F35	MV1702-6	Excavators - spoons	Asa Light MV	F14	MV1809-5	Curettes and Scalers · Goldman-Fox	Asa Light MV	G6
MV1201-3	Filling instruments - amalgam	Asa Light MV	F26	MV1217-11	Filling instruments - plastic	Asa Light MV	F35	MV1703-14	Excavators - spoons	Asa Light MV	F14	MV1809-6	Curettes and Scalers · Goldman-Fox	Asa Light MV	G6
MV1201-3L	Filling instruments - amalgam	Asa Light MV	F26	MV1218-6	Filling instruments - plastic	Asa Light MV	F35					MV1810-07	Files · Hirschfeld	Asa Light MV	G22
MV1202-1	Filling instruments - amalgam	Asa Light MV	F27	MV1219-179	Filling instruments - plastic	Asa Light MV	F35					MV1811-37	Chisels · back-action · Rhodes	Asa Light MV	G26
MV1202-1L	Filling instruments - amalgam	Asa Light MV	F27	MV1220-B2	Filling instruments - Burnishers	Asa Light MV	F31					MV1812-02S	Files · Sugarman	Asa Light MV	G22
MV1202-2	Filling instruments - amalgam	Asa Light MV	F27	MV1221-31	Filling instruments - Burnishers	Asa Light MV	F31					MV1812-04S	Files · Sugarman	Asa Light MV	G22
MV1202-2L	Filling instruments - amalgam	Asa Light MV	F27	MV1230-1	Bone compactors		E35					MV1813-10	Files · Schluger	Asa Light MV	G22
MV1202-3	Filling instruments - amalgam	Asa Light MV	F27	MV1230-2	Bone compactors		E35					MV1813-14	Files · Schluger	Asa Light MV	G22
MV1202-3L	Filling instruments - amalgam	Asa Light MV	F27	MV1231-1	Bone applicator	Asa Light MV	E29					MV1824-14	Curettes and Scalers · anterior · Indiana University	Asa Light MV	G5
MV1202-4	Filling instruments - amalgam	Asa Light MV	F27	MV1301	Operative instruments	Asa Light MV	F39					MV1824-18	Curettes and Scalers · posterior · Indiana University	Asa Light MV	G5
MV1202-4L	Filling instruments - amalgam	Asa Light MV	F27	MV1302	Operative instruments	Asa Light MV	F39					MV1825-12	Curettes and Scalers · Mc Call	Asa Light MV	G7
MV1203-1	Filling instruments - amalgam	Asa Light MV	F27									MV1825-14	Curettes and Scalers · Mc Call	Asa Light MV	G7
MV1203-2	Filling instruments - amalgam	Asa Light MV	F27									MV1825-14S	Curettes and Scalers · Mc Call	Asa Light MV	G7
MV1203-3	Filling instruments - amalgam	Asa Light MV	F27									MV1825-18S	Curettes and Scalers · Mc Call	Asa Light MV	G7
												MV1825-20	Curettes and Scalers · Mc Call	Asa Light MV	G7
												MV1826-T03	Curettes and Scalers · Taylor	Asa Light MV	G8
												MV1827-204S	Curettes and Scalers	Asa Light MV	G8
												MV1829-CK6	Curettes and Scalers · Crane-Kaplan	Asa Light MV	G8
												MV1830-YG08	Curettes and Scalers · Younger-Good	Asa Light MV	G8
												MV1831-32	Curettes and Scalers · Jacqueline	Asa Light MV	G9
												MV1831-33	Curettes and Scalers · Jacqueline	Asa Light MV	G9
												MV1831-35	Curettes and Scalers · Jacqueline	Asa Light MV	G9

code	description	handle	page	code	description	handle	page	code	description	handle	page	code	description	handle	page
MV1831-38	Curettes and Scalars · Jacquette	Asa Light MV	G9	PR1857-1	Exciser	Perfection	D68	S1700-2	Excavators - spoons	Asa60	F13	S2801A-12	Perforated stainless steel impression trays - ANATOMIC		J15
MV1850-9A	Periosteals and Elevators · Allen	Asa Light MV	E23				E22	S1700-3	Excavators - spoons	Asa60	F13				
			G16	PR1859-1	Sinus lift instruments	Perfection	E14	S1700-4	Excavators - spoons	Asa60	F13	S2801A-6	Perforated stainless steel impression trays - ANATOMIC		J15
MV1850-GF	Periosteals and Elevators · GF Goldman-Fox	Asa Light MV	E22	PR1859-2	Sinus lift instruments	Perfection	E14	S1710-6	Excavators · SS. White	Asa60	F16				
			G16	S0100-1	Extracting forceps		D4	S1800-23	Periodontal instruments kit		G37	S2801A-8	Perforated stainless steel impression trays - ANATOMIC		J15
MV1850-M7	Periosteals and Elevators · Molt	Asa Light MV	E23	S0100-2	Extracting forceps		D5	S1806	Curettes and Scalars	Asa60	G4				
			G16	S0100-3	Extraction and oral surgery kit		D70	S1807	Gracey curettes	Asa60	G34	S2802-12	Non-perforated stainless steel impression trays		J33
MV1850-M8	Periosteals and Elevators · Molt	Asa Light MV	E23	S0100-4	Extraction and oral surgery kit		D70	S1807-3	Gracey curettes	Asa60	G34				
			G16	S0110	Extracting forceps for children		D38	S1807AF	Gracey curettes	Asa60	G34	S2802-6	Non-perforated stainless steel impression trays		J33
MV1850-M9	Periosteals and Elevators · Molt	Asa Light MV	E23	S0112	Extracting forceps for children - Klein pattern		D39	S1807AF-3	Gracey curettes	Asa60	G34				
			G16					S1807MF	Gracey curettes	Asa60	G34	S2802-8	Non-perforated stainless steel impression trays		J33
MV1851-2	Periosteals and Elevators · Hourigan	Asa Light MV	E23	S0200-10	Root elevators		D49	S1807MF-3	Gracey curettes	Asa60	G34				
			G16	S0200-6	Root elevators		D47	S1809	Curettes and Scalars	Asa60	G6	S2802A-12	Non-perforated stainless steel impression trays - ANATOMIC		J35
MV1852-1	Periosteals and Elevators · Hopkins	Asa Light MV	E24	S0244-6	Root elevators		D50	S1899	Grinding stones		G33				
			G17	S0296	Syndesmotomes instruments kit		D69	S1899	Periodontal instruments kit		G35	S2802A-6	Non-perforated stainless steel impression trays - ANATOMIC		J35
MV1852-2	Periosteals and Elevators · Hopkins	Asa Light MV	E24	S0296-1	Syndesmotomes instruments kit		D69	S2100	Simple stem Mouth Mirrors - Handles · set of 5	Octagonal	B19				
			G17	S0352	Scalpel handle and remover kit		C24	S2101	Simple stem Mouth Mirrors - Handles · set of 5	Asa60	B19	S2802A-8	Non-perforated stainless steel impression trays - ANATOMIC		J35
MV1853-15	Periosteals and Elevators · Freer	Asa Light MV	E24				E9								
			G17	S0495-6	Osteotomes		E19	S2102-IN	Simple stem Mouth Mirrors - Handles · set of 5, hollow	Exagonal	B19	S2803-10	Non-perforated stainless steel impression trays - NEW SUPER		J21
MV1853-16	Periosteals and Elevators · Freer	Asa Light MV	E24	S0498-8	Implant surgery instruments · sinus lift mini kit		E40	S2002-6	Mirrors (mouth) parallelometer with handle	Asa60	B19	S2803S-10	Non-perforated stainless steel impression trays - NEW SUPER high grip		J31
			G17	S0600-1	Periodontal first examination kit		G36	S2700	Stainless steel instrument trays · for 7 instruments		I6				
MV1854-3	Periosteals and Elevators · Mead	Asa Light MV	E24	S0600-23	First examination instruments kit		B22	S2702	Stainless steel instrument trays · for 7 instruments		I6	S2804-12	Perforated stainless steel impression trays - PERMA-LOCK		J5
			G17	S0600-6	First examination instruments kit		B22								
MV1855-1	Sinus lift instruments	Asa Light MV	E15	S0600-9	First examination instruments kit		B22	S2720-1	Stainless steel instrument trays · for 16 instruments		I5	S2804-6	Perforated stainless steel impression trays - PERMA-LOCK		J5
MV1855-2	Sinus lift instruments	Asa Light MV	E15	S0600-M	First examination instruments kit		A21	S2720-2	Stainless steel instrument trays · for 16 instruments		I5				
MV1855-3	Sinus lift instruments	Asa Light MV	E15	S0601-1	Cotton and dressing pliers · Flagg		B4	S2721-1	Stainless steel instrument trays · for 16 instruments		I4	S2804-8	Perforated stainless steel impression trays - PERMA-LOCK		J5
MV1855-4	Sinus lift instruments	Asa Light MV	E15	S0601-2	Cotton and dressing pliers · London-College		B4								
MV1855-5	Sinus lift instruments	Asa Light MV	E15	S0601-3	Cotton and dressing pliers · Meriam		B4	S2722-1	Stainless steel instrument trays · for 16 instruments		I4	S2804A-12	Perforated stainless steel impression trays - PERMA-LOCK anatomic		J7
MV1855-6	Sinus lift instruments	Asa Light MV	E15	S0645	Tissue pliers set		C42	S2722-2	Stainless steel instrument trays · for 23 instruments		I4				
MV1856-1	Sinus lift instruments	Asa Light MV	E13	S0690-2	Ultralight Retractor		B21	S2723-1	Stainless steel instrument trays · for 8 instruments		I7	S2804A-6	Perforated stainless steel impression trays - PERMA-LOCK anatomic		J7
MV1856-2	Sinus lift instruments	Asa Light MV	E13	S0700-11	Single ended Explorers	Asa60	B7	S2723-2	Stainless steel instrument trays · for 4 instruments		I7				
MV1856-3	Sinus lift instruments	Asa Light MV	E13	S0700-16	Single ended Explorers	Asa60	B7	S2724-1	Stainless steel instrument trays · for 8 instruments		I7	S2804A-8	Perforated stainless steel impression trays - PERMA-LOCK anatomic		J7
MV1856-4	Sinus lift instruments	Asa Light MV	E13	S0700-23	Single ended Explorers	Asa60	B7								
MV1856-5	Sinus lift instruments	Asa Light MV	E13	S0700-6	Single ended Explorers	Asa60	B7	S2731-1	Stainless steel rubber dam clamp tray with 8 different clamps		F11	S2804S-12	Perforated stainless steel impression trays - PERMA-LOCK high grip		J9
MV1856-6	Sinus lift instruments	Asa Light MV	E14	S0700-9	Single ended Explorers	Asa60	B7	S2731-12	Stainless steel rubber dam clamp tray with 12 different clamps		F11				
MV1856-7	Sinus lift instruments	Asa Light MV	E14	S0702L-23	Endodontic kit · Boston university		B25	S2760-A	Colored silicone burs holder · Orange		E34	S2804S-8	Perforated stainless steel impression trays - PERMA-LOCK high grip		J9
MV1856-8	Sinus lift instruments	Asa Light MV	E14	S0702L-7	Endodontic kit · 7 Laser System instruments		B25	S2760-C	Colored silicone burs holder · Blue		E34				
MV1883	Membrane placement instrument · Buser	Asa Light MV	E31	S0800	Endodontic kit		B25	S2780-IMP	Implant surgery instruments		E39	S2806-8	Perforated stainless steel impression trays - edentulous		J11
MV1902-1	Scalers · Towner Jacquette	Asa Light MV	G14	S0903-1	Cement spatulas		F22	S2800-12	Perforated aluminum impression trays		J37	S2807-12	Non-perforated stainless steel impression trays - PERMA-LOCK		J23
MV1902-2	Scalers · Towner Jacquette	Asa Light MV	G14	S0903-2	Cement spatulas		F22	S2801-12	Perforated stainless steel impression trays		J13				
MV1904-H5	Scalers	Asa Light MV	G14	S0903-3	Cement spatulas		F22	S2801-6	Perforated stainless steel impression trays		J13	S2807-6	Non-perforated stainless steel impression trays - PERMA-LOCK		J23
MV1904-H6	Scalers	Asa Light MV	G14	S1102-1	Separating spatulas - AsaLady · Heidemann	Asa60	F24	S2801-8	Perforated stainless steel impression trays		J13				
MV1905-02	Scalers	Asa Light MV	G14	S1102-2	Separating spatulas - AsaLady · Heidemann	Asa60	F24					S2807A-12	Non-perforated stainless steel impression trays - PERMA-LOCK anatomic		J25
MV2000-4	Bone curettes · Hemingway	Asa Light MV	G20	S1102-3	Separating spatulas - AsaLady · Heidemann	Asa60	F24								
MV2001-85	Bone curettes · Lucas	Asa Light MV	G20	S1200-1	Filling instruments - amalgam	Asa60	F26					S2807A-6	Non-perforated stainless steel impression trays - PERMA-LOCK anatomic		J25
MV2001-86	Bone curettes · Lucas	Asa Light MV	G20	S1200-2	Filling instruments - amalgam	Asa60	F26								
MV2001-87	Bone curettes · Lucas	Asa Light MV	G20	S1200-3	Filling instruments - amalgam	Asa60	F26					S2807A-8	Non-perforated stainless steel impression trays - PERMA-LOCK anatomic		J25
MV2001-88	Bone curettes · Lucas	Asa Light MV	G20	S1200-4	Filling instruments - amalgam	Asa60	F26								
MV2002-1	Bone files · Wahl	Asa Light MV	G23	S1200-5	Filling instruments - amalgam	Asa60	F26								
MV2002-2	Bone files · Wahl	Asa Light MV	G23	S1200T	Filling instruments - amalgam	Asa60	F25								
PR0460-15TC	Needle holders · with curved jaws · Castroviejo TC		C18	S1220	Composite instruments · Felt	Alu60	F32								
			E6	S1222-15	Composite instruments		F51								
PR0625-2	Suture pliers		C40	S1222-7	Composite instruments		F51								
			E36	S1400	Filling instruments - amalgam · Markley	Asa60	F29								
PR0625-3	Suture pliers		C40	S1700	Excavators - spoons	Asa60	F13								
			E36	S1700-0	Excavators - spoons	Asa60	F13								
PR0632-1	Tissue pliers · Cooley		C38	S1700-1	Excavators - spoons	Asa60	F13								
PR1801-1	Bone chisels and gouges	Perfection	G27												
PR1850-1	Periosteals and Elevators	Perfection	E24												
			G18												
PR1850-M	Exciser · Buser	Perfection	E22												
			G16												

code	description	handle	page	code	description	handle	page	code	description	handle	page	code	description	handle	page
S2807S-12	Non-perforated stainless steel impression trays - PERMA-LOCK high grip		J27	SLV1807AF	Gracey curettes	Leonardo Light LV	G34	VVPEN	Vision® Shade · marker suitable for food contact		F3	W0349-3	Scalpel handles - AsaLady		C26
S2807S-6	Non-perforated stainless steel impression trays - PERMA-LOCK high grip		J27	SLV1807MF	Gracey curettes	Leonardo Light LV	G34	W0121-101	Extracting forceps - American pattern, AsaLady · Hull		D31	W0411-15	Needle holders - AsaLady · Crile-Wood		C11
S2807S-8	Non-perforated stainless steel impression trays - PERMA-LOCK high grip		J27	SMC0600-23	First examination instrument kit - Magic Color		B23	W0121-10S	Extracting forceps - American pattern, AsaLady		D29	W0411-15TC	Needle holders - AsaLady · Crile-Wood TC		C11
S2808-8	Non-perforated stainless steel impression trays - edentulous		J29	SMC0600-6	First examination instrument kit - Magic Color		B23	W0121-150	Extracting forceps - American pattern, AsaLady · Cryer		D32	W0412-16	Needle holders - AsaLady · Mayo-Hegar		C12
S2809-6	Perforated stainless steel impression trays - anterior depressed		J10	SMC0600-9	First examination instrument kit - Magic Color		B23	W0121-150S	Extracting forceps - American pattern, AsaLady · Cryer		D32	W0412-16TC	Needle holders - AsaLady · Mayo-Hegar		C12
S2810-6	Non-perforated stainless steel impression trays - anterior depressed		J28	SMC0700-5	Diagnostic instruments kit - Magic Color		B24	W0121-151	Extracting forceps - American pattern, AsaLady · Cryer		D32	W0502-1	Hemostats - AsaLady · straight · Halstead-Mosquito		C21
S2811-1	Perforated stainless steel impression trays · Ehrlicke		J16	SMC0800-5	Endodontic instruments kit - Magic Color		B24	W0121-151S	Extracting forceps - American pattern, AsaLady · Cryer		D32	W0502-2	Hemostats - AsaLady · curved · Halstead-Mosquito		C21
S2811-2	Perforated stainless steel impression trays · Ehrlicke		J16	SMC1807	Gracey curettes	Magic Color MC	G34	W0121-16	Extracting forceps - American pattern, AsaLady		D29	W0610-1	Cotton and dressing pliers - AsaLady · Flagg		B5
S2811-3	Perforated stainless steel impression trays · Ehrlicke		J17	SMC1807-5	Periodontal instruments kit		G35	W0121-17	Extracting forceps - American pattern, AsaLady		D29	W0610-2	Cotton and dressing pliers - AsaLady · London College		B5
S2811-4	Perforated stainless steel impression trays · Ehrlicke		J17	SML1807AF	Gracey curettes	Leonardo ML	G34	W0121-18L	Extracting forceps - American pattern, AsaLady · Harris		D30	W0610-3	Cotton and dressing pliers - AsaLady · Meriam		B5
S2813	Perforated stainless steel impression trays - edentulous		J19	SML1807MF	Gracey curettes	Leonardo ML	G34	W0121-18R	Extracting forceps - American pattern, AsaLady · Harris		D30	W3035	Clamp forceps - AsaLady · Ivory lightweight		F9
S2816-6	Perforated aluminum impression trays - ORTHOBABY for children		J39	SMV1400	Filling instruments - amalgam · Markley	Asa Light MV	F29	W0121-222	Extracting forceps - American pattern, AsaLady		D32	W3036	Punching forceps - AsaLady · Ainsworth		F8
S2851-24	Polycarbonate impression trays - edentulous		J43	SMV1700	Excavators - spoons	Asa Light MV	F13	W0121-23	Extracting forceps - American pattern, AsaLady		D30	WML1102-1	Separating spatulas - AsaLady · Heidemann	Leonardo ML	F24
S2880-12	Perforated aluminum impression trays for implantology		J38	SMV1806	Curettes and Scalers	Asa Light MV	G4	W0121-5	Extracting forceps - American pattern, AsaLady · Physick		D29	WML1102-2	Separating spatulas - AsaLady · Heidemann	Leonardo ML	F24
S2880-12FR	Perforated aluminum impression trays for implantology		J38	SMV1807	Gracey curettes	Asa Light MV	G34	W0121-53L	Extracting forceps - American pattern, AsaLady		D30	WML1102-3	Separating spatulas - AsaLady · Heidemann	Leonardo ML	F24
S3000	Rubber dam instrument kit		F10	SMV1809	Curettes and Scalers	Asa Light MV	G6	W0121-53R	Extracting forceps - American pattern, AsaLady		D30				
S3001-20	Implant surgery instruments · Goracci kit		E40	SPR0495	Implant surgery instruments · Sinus lift mini kit		E39	W0121-6	Extracting forceps - American pattern, AsaLady		D29				
S3002-13	Instruments kit for oral surgery		C46	SPR0496	Implant surgery instruments · Sinus lift maxi kit		E38	W0121-65	Extracting forceps - American pattern, AsaLady		D31				
S3002-17	Instruments kit for oral surgery		C46	SPR2781-I	Implant surgery kit		E38	W0121-69	Extracting forceps - American pattern, AsaLady · Tomes		D31				
S3002-18	Instruments kit for oral surgery		C47	SPR2781-P	Periodontal surgery kit		G36	W0121-88L	Extracting forceps - American pattern, AsaLady · Nevius		D31				
S3003-11	Implant surgery instruments		E41	SPR2781-S	Oral surgery kit		D70	W0121-88R	Extracting forceps - American pattern, AsaLady · Nevius		D31				
S3003-9	Implant surgery instruments		E41	SVS2731-6	Vision® Shade · stainless steel magnetic locking tray with 6 clamps		F2	W0160-1	Extracting forceps - AsaLady		D21				
S5112	Amalgam/wax carvers	Asa60	K17	SVS3000	Vision® Shade kit		F3	W0160-13	Extracting forceps - AsaLady		D21				
S5112AL	Amalgam/wax carvers	Alu80	K17	SWML0600-23	First examination instrument kit - AsaLady		B22	W0160-145	Extracting forceps - AsaLady		D23				
S5160	Waxing instruments with replaceable tips		K18	SWML0600-6	First examination instrument kit - AsaLady		B22	W0160-151/	Extracting forceps - AsaLady		D23				
S5160-1C	Waxing instruments with replaceable tips	Alu80	K18	SWML0600-9	First examination instrument kit - AsaLady		B22	W0160-17	Extracting forceps - AsaLady		D21				
S5160-2C	Waxing instruments with replaceable tips	Alu80	K18	VS3045	Vision® Shade · pack of 60 rubber dams (black, mint-flavored dams)		F2	W0160-18	Extracting forceps - AsaLady		D21				
S5160-3C	Waxing instruments with replaceable tips	Alu80	K18	VS3051-210	Vision® Shade · winged clamp		F2	W0160-2	Extracting forceps - AsaLady		D21				
S5800	Pliers tray		I12	VS3052-12A	Vision® Shade · winged, serrated clamp		F2	W0160-21	Extracting forceps - AsaLady		D22				
S6810-1	"Lab Set" for Laboratory		K35	VS3052-13A	Vision® Shade · winged, serrated clamp		F2	W0160-22	Extracting forceps - AsaLady		D22				
S6810-2	"Lab Set" for Laboratory		K35	VS3052-2	Vision® Shade · winged clamp		F2	W0160-33	Extracting forceps - AsaLady		D22				
S6811-1	"Lab Set" for Laboratory		K34	VS3052-W4	Vision® Shade · wingless clamp		F2	W0160-4	Extracting forceps - AsaLady		D21				
S6811-2	"Lab Set" for Laboratory		K34	VS3052-W8	Vision® Shade · wingless clamp		F2	W0160-45	Extracting forceps - AsaLady		D22				
S7000-10	Ceramic sculpturing brushes		K20	VV2731-6	Vision® Shade · stainless steel magnetic locking tray without clamps		F2	W0160-51A	Extracting forceps - AsaLady		D22				
SLV1807	Gracey curettes	Leonardo Light LV	G34	VV3030	Vision® Shade · stainless steel clamp forceps		F2	W0160-67A	Extracting forceps - AsaLady		D22				
				VV3033	Vision® Shade · stainless steel punch forceps		F2	W0160-7	Extracting forceps - AsaLady		D21				
				VV3035	Vision® Shade · stainless steel punching template		F2	W0160-79	Extracting forceps - AsaLady		D22				
				VV3040-2	Vision® Shade · stainless steel dam frame 100x150 mm		F2	W0160-74	Extracting forceps - AsaLady		D23				
								W0160-86C	Extracting forceps - AsaLady		D23				
								W0298-3	Syndesmotomes - AsaLady · Chompret		D65				
								W0319-1	Gum scissors - AsaLady · straight		C3				
								W0319-2	Gum scissors - AsaLady · curved		C3				

NAME INDEX

description	page
Alginate remover (AsaClean)	J40
Amalgam carriers	F21
Applicators (bone)	E29
Articulator 5002	K6
Articulator 5030	K4
Articulator 5032	K5
Articulator 5050	K2
Articulator 5050Plus	K3
Articulators (adjusting screw - side shift)	K9
Articulators (adjusting screw locknut)	K9
Articulators (adjusting screw)	K9
Articulators (back rod support)	K9
Articulators (back rod)	K9
Articulators (bearing rod)	K9
Articulators (cast fastening washers)	K7
	K9
Articulators (condylar guidance)	K9
Articulators (fast caliper)	K9
Articulators (hinge rod spring)	K9
Articulators (hinge rod washer)	K9
Articulators (hinge rod)	K9
Articulators (incisal guide rod)	K9
Articulators (incisal guide table 0°)	K9
Articulators (incisal guide table 10°)	K9
Articulators (incisal pin)	K9
Articulators (inclined contrast table)	K9
Articulators (knurled knob for template and occlusal table)	K9
Articulators (locking knobs for spacer)	K9
Articulators (locking knobs)	K9
Articulators (M5 screw - incisal table)	K9
Articulators (magnet holder)	K7
	K9
Articulators (magnet)	K7
	K9
Articulators (magnetic mounting plate - complete)	K7
	K9
Articulators (magnetic rod kit)	K9
Articulators (magnetic rod)	K9
Articulators (metallic locking knobs)	K9
Articulators (mounting plate)	K6
	K9
Articulators (occlusal table assembly)	K9
Articulators (occlusal table)	K9
Articulators (rod ferrule)	K9
Articulators (rubber cap)	K9
Articulators (rubber nubs)	K9
Articulators (side shift cylinder)	K9
Articulators (side shift spring)	K9
Articulators (spacer)	K7
	K9
Articulators (support for occlusal table and template)	K9
Articulators (table for magnetic rod)	K9
Articulators (template)	K9
Aspirators	E33

description	page
Bibs	A19
Blades-micro	C27, E9
Bone rongeurs	D42..D44
	E30
	G30
Bone thickness gauge	E31
Bone/soft tissue nipper	D44
	E29
	G30
Bowls for mixing	K26
Boxes for Endodontic	I14
	I15
Boxes for Prothesis	H47
	K27
Brushes for ceramic	K20
Bur Holders (silicone)	E34
	I17
Burners	I19
Burners (Accessories)	I19
Burnishers	F31
Burs (trephine) graduated	E34
Burs Holder (Aluminum)	E34
	I17
Burs Holder Cover (Silicone)	E34
	I17
Calipers	E33
	F42
	K30
Calipers - Aluminum, graded in mm and inches	K30
Calipers (metal and wax)	F42
	K30
Carvers	F36..F38
	K13
Carvers - amalgam	F27
	F29
	F35
	F36
	F38
	K13
Carvers - amalgam - cleoid-discoid	F38
Carvers - amalgam - interproximal Off-angle	F37
	F48
Carvers - amalgam/wax	F36
	F37
	K13
Carvers - wax	K14..K17
	F48
	F50
Carvers - wax (Aluminum)	K17
Case for instruments and pliers	D71
Case for instruments and pliers (inserts)	D71
Cassettes (instrument) - for 10 instruments - Blue	I2
Cassettes (instrument) - for 10 instruments - Green	I2
Cassettes (instrument) - for 10 instruments - Orange	I2

description	page
Cassettes (instrument) - for 10 instruments - Red	I2
Cassettes (instrument) - for 15 instruments - Blue	I2
Cassettes (instrument) - for 15 instruments - Green	I2
Cassettes (instrument) - for 15 instruments - Orange	I2
Cassettes (instrument) - for 15 instruments - Red	I2
Cassettes (instrument) - for 20 instruments - Blue	I2
Cassettes (instrument) - for 20 instruments - Green	I2
Cassettes (instrument) - for 20 instruments - Orange	I2
Cassettes (instrument) - for 20 instruments - Red	I2
Cassettes (instrument) - for 5 instruments - Blue	I2
	I3
Cassettes (instrument) - for 5 instruments - Green	I2
	I3
Cassettes (instrument) - for 5 instruments - Orange	I2
	I3
Cassettes (instrument) - for 5 instruments - Red	I2
	I3
Cassettes (instruments) - implant - h.60 mm	I2
Cavity preparation instruments - chisels	F18
Cavity preparation instruments - hatchets	F18
Cavity preparation instruments - margin trimmers - distal	F18
	F19
Cavity preparation instruments - margin trimmers - mesial	F19
Ceramic instruments	K21
Ceramic sculpturing instruments	K21
	F49
Ceramic sculpturing instruments (tips)	K18
Chain for Patient Bibs	A7
Chisels	F18
	G26
Chisels - TG Chisel	G26
Chisels (bone)	G27
Chisels and gouges (bone)	G27
	G28
Clamps (Vision - Xlayer)	F2
Clamps for Rubber Dam (winged, serrated)	F5..F7
Clamps for Rubber Dam (winged)	F4..F7
Clamps for Rubber Dam (wingless)	F5..F7
Clips for locking trays for scissors	I3
Compactors (bone)	E35
Compass	J19
Composite instruments	F32
	F50
Condensers (vertical)	B15
Containers for tray (Aluminum)	I13
Crown instruments	F40..F43
	K29
Crown instruments - curved and straight	F43
Cups	A20
Curettes (bone)	C45
	E21
	G20
	G21
Curettes (Gracey)	G11..G13
Curettes and Scalers	G4..G9
Cutters for Orthodontic	H4..H9
Cutters for plaster	K31
Dam (Vision)	F2
Dams (latex)	F8
Dappen dishes	A8
	A9
Depth gauges	E32
Dispensers (Aluminum)	I18
Dispensers (cotton pellet) stainless steel	I19

description	page
Dispensers (drinking cup)	A20
Elastic instruments	H35
Elevators	D47
	D49
	D50
	E22..E24
	G16..G18
Endodontic instruments	B16
Endometers	I16
Excavators	B15
	F13..F17
Excavators - oval spoons	F15
Excavators - spoons	F13
	F14
Excavators (root-canal)	B15
	F14
Excisers	D68
	E22
	G17
Explorers - Probes (combination)	B10
	B11
Explorers (Double ended)	B8
	B9
	B11
Explorers (Root canal)	B9
	B10
Explorers (Single Ended)	B6
Extracting forceps	D4..D20
	D24
Extracting forceps - American pattern	D25..D28
Extracting forceps - anatomic handle	D33..D36
Extracting forceps (AsaLady)	D21..D23
	D29..D31
Extracting forceps for children	D37..D39
Extracting forceps for root splinters	B16
	D41
Extracting forceps for roots	D40
Face Bow (complete set - Easy Bow)	K10
Face Bow (Fork holder)	K10
Face Bow (Fork)	K10
Face Bow (Transfer Table)	K10
Files	G22
Files (Asa Light)	G22
Files (bone)	E21
	G23
Filling instruments - amalgam	F26..F30
	F48
	F49
Filling instruments - Burnishers	F31
	F49
Filling instruments - plastic	F33..F35
	F48
	F50
Forceps (dressing) - curved	C32
Forceps (dressing) - straight	C32
Forceps (tongue)	C33
Forceps for clamp (Vision)	F2
Forceps for Clamps	F9
Forceps for clamps (AsaLady)	F9
Forceps for dam punching	F8
Forceps for punching (AsaLady)	F8
Forceps for punching (Vision)	F2
Forceps for sterilization	I13
Frame (silicone) - for 10 places - Blue	I3

description	page	description	page	description	page	description	page
Frame (silicone) - for 10 places - Green	I3	Impression trays for edentulous (non perforated - stainless steel)	J29	Kit Impression Trays for children (Aluminum - perforated)	J39	Orthodontic hand instruments	H34..H36
Frame (silicone) - for 10 places - Orange	I3	Impression trays for edentulous (perforated - stainless steel)	J11	Kit Impression Trays for edentulous (polycarbonate)	J43	Orthodontic hand instruments - curved	H36
Frame (silicone) - for 10 places - Red	I3		J18	Kit Impression Trays for edentulous (stainless steel - non perforated)	J29	Osteotomes	E18..E20
Frame for 5 places - Blue - silicone	I3	Impression trays for edentulous (polycarbonate)	J43	Kit Impression Trays for edentulous (stainless steel - perforated)	J11	Periodontal instrument	G30
Frame for 5 places - Green - silicone	I3	Impression trays for implantology (perforated - aluminum - colour-coded)	J41		J19	Periosteals	E22
Frame for 5 places - Orange - silicone	I3	Impression trays for implantology (perforated - Aluminum)	J38	Kit of grinding stones	G33		G16
Frame for 5 places - Red - silicone	I3	Injector (bone)	E27	Kit Impression Trays for implantology (Aluminum - perforated)	J38	Periosteals and Elevators	E24
Frames (Vision)	F2	Kit (ceramic sculpturing brushes)	K20	Kit periodonatal instruments (Magic Color)	G35		E25
Frames for rubber dam (plastic)	F9	Kit (endodontic)	B25	Kit Pliers (cotton and dressing)	B4		G17..G19
Frames for rubber dam (stainless steel)	F9	Kit (implant surgery)	E37	Kit Pliers (tissue)	C42	Periotomes	E29
Gags (mouth)	C33		E39	Kit rubber dam (Vision)	F3		D68
Gloves for examination	A15	Kit (oral surgery)	C46	Kit scalpels handles	C24	Placement Instruments	E31
Gloves for examination (nitrile)	A16		C47		E9	Pliers (cotton and dressing - AsaLady)	B5
	A17	Kit (Periodontal)	C47	Kit Spatulas	F22	Pliers (cotton and dressing)	B3..B5
Handle for mouth mirror (kit)	B19		D70	Kit Spatulas (AsaLady)	F24		K19
Handles for cone-socket mirrors	B19	Kit Carvers	G35	Kit syndesmotomes	D69	Pliers (tissue)	C38..C43
	B20	Kit Composite	G36	Kit trays+ clamps (Vision)	F2		E36
Handles for mouth mirror	B19		G37	Kit Ultralight retractors	B21	Pliers for Orthodontic	H10..H33
Hemostats - curved	C20	Kit Curettes	K17	Kit Waxing instruments	K18	Pluggers (Root canal)	B13..B15
	C23	Kit Curettes and Scalers	F32	Knives for gingivectomy	G24	Pocket markers (periodontal)	B3
Hemostats - straight	C20..C23		F51		G25		E35
	F44	Kit Curette (Gracey)	G34	Knives for plaster	K23		G31
Hemostats (AsaLady)	C21	Kit Curettes and Scalers	G4	Knives for wax	K22	Pocket probes (periodontal)	E32
Holders (silicone) - for 10 places - Blue	I3		G6	Laboratory Set	K34		G3
Holders (silicone) - for 10 places - Green	I3	Kit Curettes Gracey (Leonardo)	F29		K35	Pouches for sterilization	A18
Holders (silicone) - for 10 places - Orange	I3	Kit Curettes Gracey (Magic Color)	G34	Ligature Instruments	H35	Probes (antrum)	C37
Holders (silicone) - for 10 places - Red	I3	Kit Diagnostic (Magic Color)	B24	Mallets	E16	Retainers for matrix	F46
Holders (silicone) - for 5 places - Blue	I3	Kit Endodontic (Magic Color)	B24		K31		F47
Holders (silicone) - for 5 places - Green	I3	Kit Excavators	F13	Markers (Vision)	G29	Retractors	C35..C37
Holders (silicone) - for 5 places - Orange	I3	Kit Explorers	B7	Markers for brackets	F3		E10
Holders (silicone) - for 5 places - Red	I3	Kit Filling Instruments	F29	Masks for surgery	A14	Retractors - Tongue depressors	C34
Ice (synthetic)	A22	Kit First examination	A21	Matrix	F47		E11
Impression trays (non perforated - permalock - stainless steel - anatomic)	J24		B22	Mills (bone)	E27	Retractors - ultralight	B21
Impression trays (non perforated - permalock - stainless steel - high grip)	J26	Kit First examination (AsaLady)	B22	Mirrors - ultralight	B21	Rolls (cotton)	A12
Impression trays (non perforated - permalock - stainless steel)	J22	Kit First examination (Magic Color)	B23	Mirrors (cone-socket)	B20	Rolls for sterilization	A13
	J24	Kit for implant surgery (perfection)	E38	Mirrors (mouth) parallelometer	B19	Root elevators	D45..D63
Impression trays (non perforated - stainless steel - anatomic)	J34		E39	Mirrors (photographic)	B17	Root-tip picks	D64
Impression trays (non perforated - stainless steel - NEW SUPER)	J20	Kit for oral surgery (perfection)	D70	Mirrors (simple stem)	B18	Rubber dam instrument kit	F10
	J30	Kit for periodontal surgery (perfection)	G36		B20		F11
Impression trays (non perforated - stainless steel)	J32	Kit for rubber dam	F10	Mirrors (simple stem) - rhodium	B18	Ruler for endodontic	B15
	J34		F11	Mirrors (simple stem) - titanium	B18	Saliva ejectors	A4
Impression trays (partial occlusal - stainless steel)	J40	Kit for Sinus lift	E40	Mucotomes - curved	E26		A5
Impression trays (perforated - Aluminum)	J36	Kit Goracci	E40	Mucotomes - straight	E26	Saliva ejectors (Asa Fresh)	A2
Impression trays (perforated - permalock - stainless steel - anatomic)	J6	Kit Impression Trays (Aluminum)	J37	Napkins (AsaRainbow)	A6. A7	Saliva ejectors (Total Comfort)	A3
	J8	Kit Impression Trays (stainless steel - non perforated - anatomic)	J21	Needle holders	C10..C19	Saliva ejectors for surgery (stainless steel)	C44
Impression trays (perforated - permalock - stainless steel with retention rim)	J4		J31		E5	Saliva ejectors for surgery (tips)	C44
	J6	Kit Impression Trays (stainless steel - non perforated - permalock)	J23	Needle holders - light pattern	C14	Saws	K33
Impression trays (perforated - permalock - stainless steel)	J4		J25	Needle holders - scissors combined	C10	Scalers	G4..G8
Impression trays (perforated - stainless steel - anatomic)	J14		J27		C14		G14
Impression trays (perforated - stainless steel)	J12	Kit Impression Trays (stainless steel - non perforated)	J33	Needle holders - smooth action	C15		G15
	J14	Kit Impression Trays (stainless steel - perforated - anatomic)	J15	Needle holders - smooth jaws	C13	Scalers - left	G15
Impression trays (plastic disposable)	A23	Kit Impression Trays (stainless steel - perforated - permalock)	J5		C19	Scalers - right	G15
Impression trays (polycarbonate)	J42		J7	Needle holders - with curved jaws	C17..C19	Scalpel blade removers	C24
Impression trays Ehricke (perforated - stainless steel)	J16	Kit Impression Trays (stainless steel - perforated)	J13		E6		E9
	J17		J16	Needle holders (AsaLady)	C11	Scalpel blades	C26
Impression trays for anterior depressed (non perforated - stainless steel)	J28	Kit Impression Trays (stainless steel - perforated)	J13		C12		C27
Impression trays for anterior depressed (perforated - stainless steel)	J10		J17	Oil	D71	Scalpel blades (AsaLady)	C26
Impression trays for children (orthodontic - polycarbonate - orthobaby)	J42	Kit Impression Trays for anterior depressed (stainless steel - non perforated)	J28		I12		E7
Impression trays for children (perforated - aluminum - orthobaby)	J39	Kit Impression Trays for anterior depressed (stainless steel - perforated)	J10	Operative instruments	F39		

description	page
Scalpel handles	C26
	C27
	E7
	E8
Scalpel handles - double cutting edge	C26
	E7
	E8
Scalpel handles - orientable blade	C24
	E9
Scalpels (graduated) curved	E17
Scalpels (graduated) straight	E17
Scalpels (single cut)	E16
Scalpels disposable	C25
	E10
Scissors (gum)	C8
Scissors (gum) angular	C3
	C6
Scissors (gum) angular, one blade serrated	C3
Scissors (gum) curved	C3..C5
	C7..C9
	E4
	K28
Scissors (gum) curved, blunt beaks	C7
Scissors (gum) curved, one blade serrated	C3
	C4
	C6
	C7
	E4
Scissors (gum) curved, sharp beaks	C7
Scissors (gum) rounded curved beaks	C9
Scissors (gum) straight	C3..C5
	C8
	C9
	E4
	F45
	K28
Scissors (gum) straight, one blade serrated	C3
	C6
	E4
Scissors for crown	F45
	K28
Scissors for gum (AsaLady)	C3
Scrapers (bone) - curved	E28
Scrapers (bone) - straight	E28
Silicone	D71
	I12
Sinus Lift Instruments	E13..E15
Spare part (cassettes) - knob complete of washers	I3
Spatulas (cement)	F22
Spatulas (plaster, alginate, elastomers)	K24..K26
Spatulas (separating - AsaLady)	F24
Spatulas (separating)	F23
	F24
Spatulas for mixing (plastic)	A21
Spreaders (Root canal)	B12
Stones for grinding	G32
	G33
Stones for grinding - fine grain	G32
Stones for grinding - medium grain	G32
Syndesmotomes	D65..D67
Syndesmotomes (AsaLady)	D65
Syndesmotomes instruments kit	D69
Syringe	C28..C30
Syringes (plastic disposable)	A20

description	page
Templates (Vision)	F2
Tongs	K32
Towel clamps	C31
Tray for endodontic	I16
Trays (Aluminum insert frames)	I8
	I9
	I11
Trays (Aluminum rack)	I13
Trays (Aluminum)	I8
	I10
	I11
Trays (instruments) stainless steel - for 16 instruments	I5
Trays (instruments) stainless steel - for 23 instruments	I5
Trays (instruments) stainless steel - for 4 instruments	I7
Trays (instruments) stainless steel - for 7 instruments	I6
Trays (instruments) stainless steel - for 8 instruments	I7
Trays (instruments) stainless steel - non-perforated base	I5..I7
Trays (instruments) stainless steel - non-perforated lid	I4
	I6
	I7
Trays (instruments) stainless steel - perforated base	I4
	I6
Trays (instruments) stainless steel - perforated lid	I4
	I6
Trays (kidney)	I12
Trays (Perforated - Aluminum)	I9
Trays (Plastic)	A10
	A11
Trays (stainless steel - 16 instr.)	I4
	I5
Trays (stainless steel - 23 instr.)	I4
	I5
Trays (stainless steel - 4 instr.)	I7
Trays (stainless steel - 7 instr.)	I6
Trays (stainless steel - 8 instr.)	I7
Trays for clamp (Vision)	F2
Trays for mixing	A21
Trays of Pliers	I12
Trimmers	F18
	F19
Tweezers - membrane holding	E37
Tweezers (Laboratory)	K19
Tweezers implant holding	E37
Waste containers	A21
	A22
	I18
	I19
Well (bone)	E32
Wells (amalgam)	F20
Trays (instruments) stainless steel - perforated base	I4
	I6
Trays (instruments) stainless steel - perforated lid	I4
	I6
Trays (kidney)	I12
Trays (Perforated - Aluminum)	I9
Trays (Plastic)	A10
	A11
Trays (stainless steel - 4 instr.)	I7
Trays (stainless steel - 7 instr.)	I6
Trays (stainless steel - 8 instr.)	I7
Trays (stainless steel - 16 instr.)	I4
	I5
Trays (stainless steel - 23 instr.)	I4
	I5

description	page
Trays for clamp (Vision)	F2
Trays for mixing	A21
Trays of Pliers	I12
Trimmers	F18
	F19
Tweezers - membrane holding	E37
Tweezers (Laboratory)	K19
Tweezers implant holding	E37
Waste containers	A21
	A22
	I18
	I19
Well (bone)	E32
Wells (amalgam)	F20

©2020 Asa Dental S.p.A.

This catalog may contain typographical errors, inaccuracies or omissions that may relate to product descriptions, specifications, dimensions, quantities, configurations and other details.

Asa Dental cannot assume any legal liability or responsibility for the accuracy or completeness of the information provided, that is intended for general guidance only.

Asa Dental reserves the right to change, replace or discontinue products without prior notice in order to improve technical features or quality.

We recommend regularly checking our website and considering it the most reliable source of up-to-date information regarding product availability, specifications, technical procedures and instructions for use.

As an alternative, you can contact our customer care.

Use of pictures, drawings and symbols available in this catalogue is subject to approval from Asa Dental and may be used only as support for advertising and promotional material of the Company and its products.

Asa Dental, AsaOne, AsaLady, AsaFresh, AsaClean, AsaLight, Perfection, Vision, Leonardo, Leonardo Light, Magic Color, Asa Codicolor, Perma-Lock are all registered trademarks of Asa Dental.

HEAD OFFICE

Asa Dental S.p.A.

Via Valenzana di Sopra, 60 - Bozzano
55054 Massarosa (Lu) - Italy
Tel. +39 0584 938305 - 93363 - 938306
Fax +39 0584 937167
asadental@asadental.it
www.asadental.com

LOGISTICS CENTER

Via Sarzanese Valdera, 1331 - Bozzano
55054 Massarosa (Lu) - Italy

PRODUCTION PLANTS

Via delle Piagge, 1/A - Marlia
55014 Capannori (Lu) - Italy

Via Fierla, 13 - Z.I.
33085 Maniago (Pn) - Italy

BRANCH OFFICES

Asa Dental USA Corp.

105 Maxess Road, Suite 124
Melville, New York 11747 - USA

Asa Dental CHINA CO. LTD.

Room 315, Huaying Building,
Zhong Xin Avenue
Tianjin Airport Economic Area
Tianjin - China

Asa Dental S.p.A. (Branch)

Dubai South Business Center
Building C, 3rd Floor
Dubai Logistics City
PO Box 390667
Dubai - UAE



ASA DENTAL

MAKE PEOPLE SMILE