

**ASTRA TECH
IMPLANT SYSTEM**

Product catalog





Contents

This catalog contains components and instruments for ASTRA TECH Implant System™.

All products are subject to change without notice. Product illustrations are not to scale. Some products may not be available in all markets. Please contact your local DENTSPLY Implants representative for current product assortment and availability.

To improve readability for our customers, DENTSPLY Implants does not use ® or ™ in body copy. However, DENTSPLY Implants does not waive any right to the trademark and nothing herein shall be interpreted to the contrary.

ASTRA TECH Implant System™	4
Product overview 3.0	5
Product overview 3.5/4.0	6
Product overview 4.5/5.0	8
Surgical components	10
Implants	10
Cover screws	12
Healing abutments	12
Temporary abutments	14
Cement-retained restorations	15
ZirDesign™	16
TiDesign™	16
CastDesign™	17
Impression & laboratory components, implant level	18
Direct Abutment API™	19
Screw-retained restorations	21
UniAbutment	22
Angled abutments	23
Impression & laboratory components, abutment level	24
Cresco™	26
Attachment-retained restorations	27
Locator™ abutments	28
Ball Abutment	29
Surgical instruments	32
Getting started	32
Drills	38
Single Patient drills	38
Multiple-use drills	40
Drilling equipment & accessories	42
Restorative instruments	44
Getting started	44
General	45
Cresco™ instruments	49
Removal/retrieval instruments	50
Index	52
Torque guide	60
Explanation of the symbols on labels and instructions for use	61

Easy to choose and easy to use

The ASTRA TECH Implant System is simple and reliable: a minimum of components with maximum flexibility. You can use it for all indications and all positions in the mouth. It is ideal for both one-stage and two-stage surgery and it is also suitable for immediate and early loading. The restorative options cover cement-, screw- and attachment-retained solutions.

Easy implant installation – simply pick up and install

The color coded Implant Driver makes implant installation quick, easy and efficient.

Minimum of components with maximum flexibility – one connection, three sizes

To minimize the number of components for simplified treatment planning and inventory management, the Conical Seal Design implant-abutment connection comes in three sizes – x-small, small and large that are color coded for easy identification.



Implant level impression – color coded components

Yellow, aqua and lilac. It has never been easier to select the right implant pick-ups, transfers, guide pins, and replicas. With the color coding system, each component is marked with the same color as the chosen implant connection.



Single Patient Drills

Optimal sharpness, easy handling and no cleaning or sterilization. The benefits of Single Patient Drills are available for all drilling protocols.



OsseoSpeed™ TX
with tapered apex –
for easier installation



Product overview 3.0

Yellow



Indexed abutments and components.



Non-indexed abutments and components (NI).

Implants

OsseoSpeed™ TX 3.0 S



11 mm 24982
13 mm 24983
15 mm 24984

Cover screws

3.0



0 mm 24198

Healing abutments

3.0



Ø 4.0 2 mm 24777
Ø 4.0 4 mm 24778
Ø 4.0 6 mm 25017

Cement-retained

Temporary abutments

Temporary Abutment 3.0



Ø 3.4 1 mm 25018

Abutments

TiDesign™ 3.0



Ø 4.0 1 mm 24788
Ø 4.0 2 mm 24789
Ø 4.0 15° 2.4 mm 24790

ATLANTIS™ abutment



Patient-specific abutment
www.atlantisabutment.com

Implant impressions

Implant Pick-up 3.0



Short 24950
Long 24949

Implant Transfer 3.0



Long 24958

Guide pins

Implant Guide Pin 3.0



Short 24970
Long 24976

Replicas

Implant Replica 3.0



24977

Lab abutment screws

Lab Abutment Screw Design 3.0



24802



Product overview 3.5/4.0

Aqua

SMALL

Indexed abutments and components.

SMALL

Non-indexed abutments and components (NI).

Implants

OsseoSpeed™ TX 3.5 S



- 8 mm 24930
- 9 mm 24931
- 11 mm 24932
- 13 mm 24933
- 15 mm 24934
- 17 mm 24935

OsseoSpeed™ TX 4.0 S



- 6 mm 24939
- 8 mm 24940
- 9 mm 24941
- 11 mm 24942
- 13 mm 24943
- 15 mm 24944
- 17 mm 24945

Cover screws

3.5/4.0



- 0 mm 24328
- 1 mm 24329

Healing abutments

3.5/4.0



- Ø 4.0 2 mm 24574
- Ø 4.5 4 mm 24575
- Ø 4.5 6 mm 24576
- Ø 5.5 2 mm 24577
- Ø 5.5 4 mm 24578
- Ø 5.5 6 mm 24579
- Ø 6.5 4 mm 24580
- Ø 6.5 6 mm 24581

Uni 3.5/4.0



- 2 mm 24374
- 4 mm 24375
- 6 mm 24376
- 8 mm 24377
- 10 mm 24378

Cement-retained

Temporary abutments

TempDesign™ 3.5/4.0



- Ø 4.1 1 mm 22851
- NI Ø 4.1 1 mm 22853

Temporary Abutment 3.5/4.0



- Ø 4.1 1 mm 24281
- NI Ø 4.1 1 mm 24280

Abutments

ZirDesign™ 3.5/4.0



- Ø 4.5 1.5 mm 24702
- Ø 4.5 3 mm 24703
- Ø 5.5 1.5 mm 24704
- Ø 5.5 3 mm 24705
- Ø 5.5 20° 3.5 mm 24706

TiDesign™ 3.5/4.0



- Ø 4.5 1.5 mm 24285
- Ø 4.5 3 mm 24286
- Ø 5.5 1.5 mm 24287
- Ø 5.5 3 mm 24288
- Ø 6.5 1.5 mm 24289
- Ø 6.5 3 mm 24290
- Ø 4.5 20° 3.5 mm 24291
- Ø 5.5 20° 3.5 mm 24292

CastDesign™ 3.5/4.0



- Ø 4 1 mm 22843

ATLANTIS™ abutment



Patient-specific CAD/CAM abutment
www.atlantisabutment.com

Screw-retained

Abutments



Cresco API™ 3.5/4.0, 20°

- 0.5 mm Titanium 30351
- 0.5 mm Burnout 30551
- 0.5 mm Cobalt-Chrome 30851
- 2 mm Titanium 30352
- 2 mm Burnout 30552
- 2 mm Cobalt-Chrome 30852

Cresco API™ 3.5/4.0, 45°

- 0.7 mm Titanium 30353
- 0.7 mm Burnout 30553
- 0.7 mm Cobalt-Chrome 30853
- 2 mm Titanium 30354
- 2 mm Burnout 30554
- 2 mm Cobalt-Chrome 30854

Angled Abutment 3.5/4.0



- Ø 4 0.8 mm 24245
- Ø 4 2 mm 24246
- NI Ø 4 0.8 mm 24347
- NI Ø 4 2 mm 24348

20° UniAbutment 3.5/4.0



- 0.5 mm 24893
- 1 mm 24894
- 2 mm 24895
- 4 mm 24896
- 6 mm 24897
- 8 mm 24898

45° UniAbutment 3.5/4.0



- 0.5 mm 24899
- 1 mm 24900
- 2 mm 24901
- 4 mm 24902
- 6 mm 24903
- 8 mm 24904

ATLANTIS ISUS™
Patient-specific CAD/CAM
implant suprastructures
www.dentsplyimplants.com

Healing caps

20° ProHeal Cap



- Ø 4.3 24162
- Ø 5.5 Short 24158
- Ø 5.5 Long 24159

45° ProHeal Cap



- Ø 4.3 24163
- Ø 5.5 Short 24160
- Ø 5.5 Long 24161

Healing Cap, Angled



24092

Attachment-retained

Abutments

Ball Abutment 3.5/4.0



- 1 mm 24905
- 2 mm 24906
- 4 mm 24907
- 6 mm 24908
- 8 mm 24909

Locator™ Abutment 3.5/4.0



- 1 mm 24268
- 2 mm 24269
- 3 mm 24270
- 4 mm 24271
- 5 mm 24272

Abutment impressions

Ball Abutment Pick-up































22439









Locator™ Abutment Pick-up



24484

<p>Direct Abutment API™ 3.5/4.0</p>  <ul style="list-style-type: none"> ∅ 4 0.5 mm 24917 ∅ 4 1 mm 24918 ∅ 4 2.5 mm 24919 ∅ 4 4 mm 24920 ∅ 5 1 mm 24921 ∅ 5 2.5 mm 24922 ∅ 5 4 mm 24923 	<p>Implant impressions</p> <div style="display: flex; justify-content: space-around;"> <div data-bbox="414 255 558 553"> <p>Implant Pick-up 3.5/4.0</p>  <ul style="list-style-type: none"> ○ Short 24947 ○ Long 24948 ○ NI Short 24936 ○ NI Long 24937 </div> <div data-bbox="622 255 766 468"> <p>Implant Transfer 3.5/4.0</p>  <ul style="list-style-type: none"> ○ Short 24959 ○ Long 24960 </div> </div>	<p>Lab abutment screws</p> <p>Lab Abutment Screw Design 3.5/4.0</p>  <p>24857</p> <p>Replicas</p> <p>Implant Replica 3.5/4.0</p>  <p>○ 24978</p>	<p>Guide pins</p> <p>Implant Guide Pin 3.5/4.0</p>  <ul style="list-style-type: none"> ○ Short 24968 ○ Long 24969
--	--	--	--

<p>Abutment impressions</p> <div style="display: flex; justify-content: space-around;"> <div data-bbox="63 936 191 1170"> <p>20° UniAbutment Pick-up</p>  <ul style="list-style-type: none"> ∅ 4.3 22882 ∅ 5.5 22876 </div> <div data-bbox="223 936 383 1106"> <p>20°/45° UniAbutment Transfer</p>  <p>22068</p> </div> </div> <div style="display: flex; justify-content: space-around; margin-top: 20px;"> <div data-bbox="63 1191 191 1425"> <p>45° UniAbutment Pick-up</p>  <ul style="list-style-type: none"> ∅ 4.3 22883 ∅ 5.5 22878 </div> <div data-bbox="223 1191 383 1404"> <p>Angled Abutment Pick-up</p>  <p>24254</p> </div> </div>	<p>Replicas</p> <div style="display: flex; justify-content: space-around;"> <div data-bbox="430 936 542 1127"> <p>20° UniAbutment Replica</p>  <p>22069</p> </div> <div data-bbox="558 936 670 1127"> <p>45° UniAbutment Replica</p>  <p>22070</p> </div> </div> <p>Angled Abutment Replica</p>  <p>24227</p> <p>Lab abutment screws angled</p> <p>Lab Abutment Screw Angled M1.6</p>  <p>24860</p>	<p>Guide pins</p> <p>Abutment Guide Pin</p>  <ul style="list-style-type: none"> 13 mm 22190 16 mm 22197 19 mm 22198 22 mm 22199 <p>Bridge screws</p> <p>Bridge Screw</p>  <ul style="list-style-type: none"> Hex 22435 Slot 22167 <p>Lab bridge screws</p> <p>Hex and Slot</p>  <p>24859</p>	<p>Temporary cylinders</p> <p>Temporary Cylinder Uni 20°</p>  <p>22060</p> <p>Temporary Cylinder Uni 45°</p>  <p>22061</p> <p>Temporary Cylinder Uni Angled</p>  <p>22447</p>	<p>Cylinders</p> <div style="display: flex; justify-content: space-between;"> <div data-bbox="1069 978 1165 1149"> <p>Semi-Burnout Cylinder Uni 20°</p>  <p>22184</p> </div> <div data-bbox="1197 978 1292 1149"> <p>Burnout Cylinder Uni 20°</p>  <p>22186</p> </div> <div data-bbox="1324 978 1420 1170"> <p>Titanium Cylinder Uni 20°</p>  <p>22798</p> </div> </div> <div style="display: flex; justify-content: space-between; margin-top: 20px;"> <div data-bbox="1069 1170 1165 1340"> <p>Semi-Burnout Cylinder Uni 45°</p>  <p>22185</p> </div> <div data-bbox="1197 1170 1292 1340"> <p>Burnout Cylinder Uni 45°</p>  <p>22187</p> </div> <div data-bbox="1324 1170 1420 1361"> <p>Titanium Cylinder Uni 45°</p>  <p>22799</p> </div> </div> <div style="display: flex; justify-content: space-between; margin-top: 20px;"> <div data-bbox="1069 1361 1165 1553"> <p>Semi-Burnout Cylinder Uni Angled</p>  <p>24243</p> </div> <div data-bbox="1197 1361 1292 1553"> <p>Burnout Cylinder Uni Angled</p>  <p>22448</p> </div> <div data-bbox="1324 1361 1420 1553"> <p>Titanium Cylinder Uni Angled</p>  <p>24244</p> </div> </div>
---	---	--	--	--

<p>Replicas</p> <div style="display: flex; justify-content: space-around;"> <div data-bbox="79 1744 191 1957"> <p>Ball Abutment Replica</p>  <p>22505</p> </div> <div data-bbox="239 1744 383 1936"> <p>Locator™ Abutment Replica</p>  <p>24485</p> </div> </div>	<p>Attachment components</p> <div style="display: flex; justify-content: space-between;"> <div data-bbox="510 1744 606 1851"> <p>Clix Female</p>  <p>22383</p> </div> <div data-bbox="686 1744 813 1851"> <p>Clix Insert</p>  <p>22384</p> </div> <div data-bbox="877 1744 1165 1851"> <p>Locator™ Process Kit</p>  <p>24483</p> </div> <div data-bbox="1228 1744 1372 1872"> <p>Profile Bar System</p>  <p>22381</p> </div> </div> <div style="display: flex; justify-content: space-between; margin-top: 20px;"> <div data-bbox="510 1872 606 1979"> <p>Ball Housing</p>  <p>22364</p> </div> <div data-bbox="861 1872 1181 1979"> <p>Locator™ Insert</p> <ul style="list-style-type: none"> Blue 24488 Pink 24487 Clear 24486 Red 24492 Green 24489 </div> <div data-bbox="1228 1872 1372 1979"> <p>Profile Bar Insert</p>  <p>22382</p> </div> </div>
--	---

Product overview 4.5/5.0

Lilac

LARGE

Indexed abutments and components.

LARGE

Non-indexed abutments and components (NI).

Implants

OsseoSpeed™ TX 4.5



- 9 mm 24951
- 11 mm 24952
- 13 mm 24953
- 15 mm 24954
- 17 mm 24955

OsseoSpeed™ TX 5.0



- 9 mm 24961
- 11 mm 24962
- 13 mm 24963
- 15 mm 24964
- 17 mm 24965

OsseoSpeed™ TX 5.0 S



- 9 mm 24971
- 11 mm 24972
- 13 mm 24973
- 15 mm 24974
- 17 mm 24975

Cover screws

4.5/5.0



- 0 mm 24447
- 1 mm 24448

Healing abutments

4.5/5.0



- Ø 5.5 2 mm 24582
- Ø 5.5 4 mm 24583
- Ø 5.5 6 mm 24584
- Ø 6.5 2 mm 24585
- Ø 6.5 4 mm 24586
- Ø 6.5 6 mm 24587

Uni 4.5/5.0



- 2 mm 24379
- 4 mm 24380
- 6 mm 24381
- 8 mm 24382
- 10 mm 24383

Cement-retained

Temporary abutments

TempDesign™ 4.5/5.0



- Ø 4.5 1 mm 22852
- NI Ø 4.5 1 mm 22854

Temporary Abutment 4.5/5.0



- Ø 4.5 1 mm 25015
- NI Ø 4.5 1 mm 25016

Abutments

ZirDesign™ 4.5/5.0



- Ø 5.5 1.5 mm 24707
- Ø 5.5 3 mm 24708
- Ø 6.5 1.5 mm 24709
- Ø 6.5 3 mm 24710
- Ø 5.5 20° 3.5 mm 24711

TiDesign™ 4.5/5.0



- Ø 5.5 1.5 mm 24235
- Ø 5.5 3 mm 24236
- Ø 6.5 1.5 mm 24237
- Ø 6.5 3 mm 24238
- Ø 5.5 20° 3.5 mm 24239

CastDesign™ 4.5/5.0



- Ø 4.5 1 mm 22844

ATLANTIS™ abutment



Patient-specific CAD/CAM abutment
www.atlantisabutment.com

Screw-retained

Abutments



- Cresco API™ 4.5/5.0, 20°**
- 0.5 mm Titanium 30312
 - 0.5 mm Burnout 30512
 - 0.5 mm Cobalt-Chrome 30812
 - 2 mm Titanium 30322
 - 2 mm Burnout 30522
 - 2 mm Cobalt-Chrome 30822

- Cresco API™ 4.5/5.0, 45°**
- 0.7 mm Titanium 30305
 - 0.7 mm Burnout 30505
 - 0.7 mm Cobalt-Chrome 30805
 - 2 mm Titanium 30310
 - 2 mm Burnout 30510
 - 2 mm Cobalt-Chrome 30810

Angled Abutment 4.5/5.0



- Ø 4 0.5 mm 24247
- Ø 4 2 mm 24248
- NI Ø 4 0.5 mm 24606
- NI Ø 4 2 mm 24607

20° UniAbutment 4.5/5.0



- 0.5 mm 24398
- 1 mm 24399
- 2 mm 24400
- 4 mm 24401
- 6 mm 24402
- 8 mm 24403

45° UniAbutment 4.5/5.0



- 0.5 mm 24406
- 1 mm 24407
- 2 mm 24408
- 4 mm 24409
- 6 mm 24410
- 8 mm 24411

ATLANTIS ISUS™
Patient-specific CAD/CAM
implant suprastructures
www.dentsplyimplants.com

Healing caps

20° ProHeal Cap



- Ø 4.3 24162
- Ø 5.5 Short 24158
- Ø 5.5 Long 24159

45° ProHeal Cap



- Ø 4.3 24163
- Ø 5.5 Short 24160
- Ø 5.5 Long 24161

Healing Cap, Angled



24092

Attachment-retained

Abutments

Ball Abutment 4.5/5.0



- 0.5 mm 24418
- 1 mm 24419
- 2 mm 24420
- 4 mm 24421
- 6 mm 24422
- 8 mm 24423

Locator™ Abutment 4.5/5.0



- 0.5 mm 24477
- 2 mm 24478
- 3 mm 24479
- 4 mm 24480
- 5 mm 24481

Abutment impressions

Ball Abutment Pick-up































22439









Locator™ Abutment Pick-up



24484

<p>Direct Abutment API™ 4.5/5.0</p>  <ul style="list-style-type: none"> ∅ 5 0.5 mm 24558 ∅ 5 1 mm 24559 ∅ 5 2.5 mm 24560 ∅ 5 4 mm 24561 ∅ 6 1 mm 24562 ∅ 6 2.5 mm 24563 ∅ 6 4 mm 24564 	<p>Implant impressions</p> <div style="display: flex; justify-content: space-around;"> <div data-bbox="422 266 534 478"> <p>Implant Pick-up 4.5/5.0</p>  <ul style="list-style-type: none"> Short 24938 Long 24946 NI Short 24928 NI Long 24929 </div> <div data-bbox="630 266 742 478"> <p>Implant Transfer 4.5/5.0</p>  <ul style="list-style-type: none"> Short 24956 Long 24957 </div> </div>	<p>Lab abutment screws</p> <p>Lab Abutment Screw Design 4.5/5.0</p>  <p>24858</p> <p>Replicas</p> <p>Implant Replica 4.5/5.0</p>  <p>24979</p>	<p>Guide pins</p> <p>Implant Guide Pin 4.5/5.0</p>  <ul style="list-style-type: none"> Short 24966 Long 24967
---	--	--	--

<p>Abutment impressions</p> <div style="display: flex; justify-content: space-around;"> <div data-bbox="63 946 183 1159"> <p>20° UniAbutment Pick-up</p>  <ul style="list-style-type: none"> ∅ 4.3 22882 ∅ 5.5 22876 </div> <div data-bbox="231 946 375 1095"> <p>20°/45° UniAbutment Transfer</p>  <p>22068</p> </div> </div> <div style="display: flex; justify-content: space-around; margin-top: 20px;"> <div data-bbox="63 1212 183 1425"> <p>45° UniAbutment Pick-up</p>  <ul style="list-style-type: none"> ∅ 4.3 22883 ∅ 5.5 22878 </div> <div data-bbox="247 1212 375 1404"> <p>Angled Abutment Pick-up</p>  <p>24254</p> </div> </div>	<p>Replicas</p> <div style="display: flex; justify-content: space-around;"> <div data-bbox="430 946 550 1117"> <p>20° UniAbutment Replica</p>  <p>22069</p> </div> <div data-bbox="566 946 678 1117"> <p>45° UniAbutment Replica</p>  <p>22070</p> </div> </div> <p>Angled Abutment Replica</p>  <p>24227</p> <p>Lab abutment screws angled</p> <p>Lab Abutment Screw Angled M2</p>  <p>24860</p>	<p>Guide pins</p> <p>Abutment Guide Pin</p>  <ul style="list-style-type: none"> 13 mm 22190 16 mm 22197 19 mm 22198 22 mm 22199 <p>Bridge screws</p> <p>Bridge Screw</p>  <ul style="list-style-type: none"> Hex 22435 Slot 22167 <p>Lab bridge screws</p> <p>Hex and Slot</p>  <p>24859</p>	<p>Temporary cylinders</p> <p>Temporary Cylinder Uni 20°</p>  <p>22060</p> <p>Temporary Cylinder Uni 45°</p>  <p>22061</p> <p>Temporary Cylinder Uni Angled</p>  <p>22447</p>	<p>Cylinders</p> <div style="display: flex; justify-content: space-around;"> <div data-bbox="1069 978 1165 1127"> <p>Semi-Burnout Cylinder Uni 20°</p>  <p>22184</p> </div> <div data-bbox="1197 978 1292 1127"> <p>Burnout Cylinder Uni 20°</p>  <p>22186</p> </div> <div data-bbox="1324 978 1420 1159"> <p>Titanium Cylinder Uni 20°</p>  <p>22798</p> </div> </div> <div style="display: flex; justify-content: space-around; margin-top: 20px;"> <div data-bbox="1069 1170 1165 1330"> <p>Semi-Burnout Cylinder Uni 45°</p>  <p>22185</p> </div> <div data-bbox="1197 1170 1292 1330"> <p>Burnout Cylinder Uni 45°</p>  <p>22187</p> </div> <div data-bbox="1324 1170 1420 1351"> <p>Titanium Cylinder Uni 45°</p>  <p>22799</p> </div> </div> <div style="display: flex; justify-content: space-around; margin-top: 20px;"> <div data-bbox="1069 1361 1165 1542"> <p>Semi-Burnout Cylinder Uni Angled</p>  <p>24243</p> </div> <div data-bbox="1197 1361 1292 1542"> <p>Burnout Cylinder Uni Angled</p>  <p>22448</p> </div> <div data-bbox="1324 1361 1420 1542"> <p>Titanium Cylinder Uni Angled</p>  <p>24244</p> </div> </div>
---	---	--	--	---

<p>Replicas</p> <div style="display: flex; justify-content: space-around;"> <div data-bbox="87 1755 183 1947"> <p>Ball Abutment Replica</p>  <p>22505</p> </div> <div data-bbox="247 1755 375 1925"> <p>Locator™ Abutment Replica</p>  <p>24485</p> </div> </div>	<p>Attachment components</p> <div style="display: flex; justify-content: space-around;"> <div data-bbox="518 1755 598 1851"> <p>Clix Female</p>  <p>22383</p> </div> <div data-bbox="686 1755 813 1840"> <p>Clix Insert</p>  <p>22384</p> </div> <div data-bbox="877 1755 1149 1840"> <p>Locator™ Process Kit</p>  <p>24483</p> </div> <div data-bbox="1228 1755 1372 1872"> <p>Profile Bar System</p>  <p>22381</p> </div> </div> <div style="display: flex; justify-content: space-around; margin-top: 20px;"> <div data-bbox="518 1883 598 1979"> <p>Ball Housing</p>  <p>22364</p> </div> <div data-bbox="869 1872 1181 1979"> <p>Locator™ Insert</p>  <ul style="list-style-type: none"> Blue 24488 Pink 24487 Clear 24486 Red 24492 Green 24489 </div> <div data-bbox="1228 1883 1372 1979"> <p>Profile Bar Insert</p>  <p>22382</p> </div> </div>
--	--

SURGICAL COMPONENTS

Implants – OsseoSpeed™ TX

MEASUREMENTS

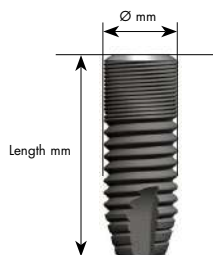

SHORT FACTS

- X-Small connection – Yellow: Implant diameter 3.0
- Small connection – Aqua: Implant diameters 3.5 and 4.0.
- Large connection – Lilac: Implant diameters 4.5 and 5.0.

Implants for all indications in both the anterior and posterior region.
 For indication details – see Instructions for use or Surgical procedures manual.
 All our implants are made of commercially pure titanium, grade 4.
 OsseoSpeed surface treatment over the entire implant to the top of the first MicroThread.
 S = Straight implant design



OsseoSpeed™ TX 3.0 S

Titanium, Sterile

OsseoSpeed, with a TiO₂-blasted fluoride-modified surface.

MicroThread neck.

Conical Seal Design connection.

Internal double hexagon.

Ø 3.0 mm

Internal thread M1.4



Length mm

REF



OsseoSpeed™ TX 3.5 S

Titanium, Sterile

OsseoSpeed, with a TiO₂-blasted fluoride-modified surface.

MicroThread neck.

Conical Seal Design connection.

Internal double hexagon.

Ø 3.5 mm

Internal thread M1.6



Length mm

REF



OsseoSpeed™ TX 4.0 S

Titanium, Sterile

OsseoSpeed, with a TiO₂-blasted fluoride-modified surface.

MicroThread neck.

Conical Seal Design connection.

Internal double hexagon.

Ø 4.0 mm

Internal thread M1.6



Length mm

REF



OsseoSpeed™ TX 4.5

Titanium, Sterile

OsseoSpeed, with a TiO₂-blasted fluoride-modified surface.

MicroThread neck.

Conical Seal Design connection.

Internal double hexagon.

Ø 4.5/3.5 mm

Internal thread M2



Length mm

REF



9	11	13	15	17
24951	24952	24953	24954	24955

OsseoSpeed™ TX 5.0

Titanium, Sterile

OsseoSpeed, with a TiO₂-blasted fluoride-modified surface.

MicroThread neck.

Conical Seal Design connection.

Internal double hexagon.

Ø 5.0/4.0 mm

Internal thread M2



Length mm

REF



9	11	13	15	17
24961	24962	24963	24964	24965

OsseoSpeed™ TX 5.0 S

Titanium, Sterile

OsseoSpeed, with a TiO₂-blasted fluoride-modified surface.

MicroThread neck.

Conical Seal Design connection.

Internal double hexagon.

Ø 5.0 mm

Internal thread M2



Length mm

REF



9	11	13	15	17
24971	24972	24973	24974	24975

Radiographic Implant Guides

REF 24892





SOFT TISSUE HEALING

Cover screws & Healing abutments

Cover Screw 3.0

Titanium, Sterile

Used to cover the implant connection during healing.

	
Ø mm	2.3
Height mm	0
REF	24198

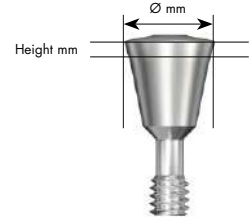

MEASUREMENTS



Cover Screw 3.5/4.0

Titanium, Sterile

Used to cover the implant connection during healing.

		
Ø mm	2.9	3.1
Height mm	0	1
REF	24328	24329



SHORT FACTS

Recommended torque – Manual.
Only light fingerforce (5–10 Ncm) using a manual hex screwdriver. Do not use a Ratchet or Torque Wrench.

Cover Screw 4.5/5.0

Titanium, Sterile

Used to cover the implant connection during healing.

		
Ø mm	3.9	4.6
Height mm	0	1
REF	24447	24448

MEASUREMENTS

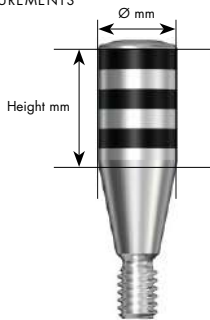

SHORT FACTS

Recommended torque – Manual.
Only light fingerforce (5–10 Ncm) using a manual hex screwdriver. Do not use a Ratchet or Torque Wrench.



Marked with lines to identify connection size.
3.5/4.0 – marked with 2 lines.
4.5/5.0 – marked with 3 lines.
Marked with digit to identify height.

Healing Abutment Uni 3.5/4.0

Titanium, Sterile



Laser etched bands for measuring mucosal height over the implant.

					
Ø mm	4	4	4	4	4
Height mm	2	4	6	8	10
REF	24374	24375	24376	24377	24378

Healing Abutment Uni 4.5/5.0

Titanium, Sterile

Laser etched bands for measuring mucosal height over the implant.

					
Ø mm	4	4	4	4	4
Height mm	2	4	6	8	10
REF	24379	24380	24381	24382	24383

Healing Abutment 3.0

Titanium, Sterile

			
Ø mm	4	4	4
Height mm	2	4	6
REF	24777	24778	25017

MEASUREMENTS

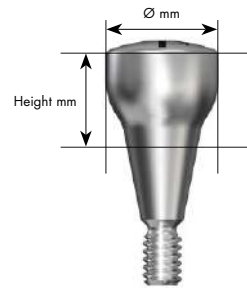





SHORT FACTS



Recommended torque – Manual.
Only light fingerforce (5–10 Ncm) using a manual hex screwdriver.
Do not use a Ratchet or Torque Wrench.

Healing Abutment 3.5/4.0

Titanium, Sterile

			
Ø mm	4	4.5	4.5
Height mm	2	4	6
REF	24574	24575	24576

			
Ø mm	5.5	5.5	5.5
Height mm	2	4	6
REF	24577	24578	24579





		
Ø mm	6.5	6.5
Height mm	4	6
REF	24580	24581



Marked with lines to identify connection size.
3.0 – marked with 1 line.
3.5/4.0 – marked with 2 lines.
4.5/5.0 – marked with 3 lines.
Marked with digits to identify diameter (Ø) and height.

Healing Abutment 4.5/5.0

Titanium, Sterile

			
Ø mm	5.5	5.5	5.5
Height mm	2	4	6
REF	24582	24583	24584

			
Ø mm	6.5	6.5	6.5
Height mm	2	4	6
REF	24585	24586	24587

SOFT TISSUE HEALING & TEMPORARY ABUTMENTS

Temporary abutments

TempDesign™ 3.5/4.0

Base: Titanium
Cylinder: Plastic

Includes Abutment Screw Design
3.5/4.0 – M1.6, REF 24449
(Titanium)
NI = Non Indexed



Ø mm	4.1	4.1
Height (margin) mm	1	1
Vert. height mm	10	10
REF	22851	22853

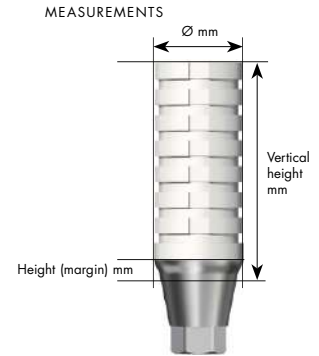
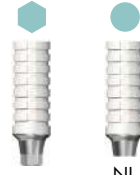

SHORT FACTS
Recommended torque for
temporization – 15 Ncm.

TempDesign™ 4.5/5.0

Base: Titanium
Cylinder: Plastic

Includes Abutment Screw Design
4.5/5.0 – M2, REF 24209
(Titanium)



Ø mm	4.5	4.5
Height (margin) mm	1	1
Vert. height mm	10	10
REF	22852	22854



Temporary Abutment 3.0

Titanium

Includes Abutment Screw 3.0
– M1.4, REF 24189
(Titanium)



Ø mm	3.4
Height (margin) mm	1
Vert. height mm	9
REF	25018

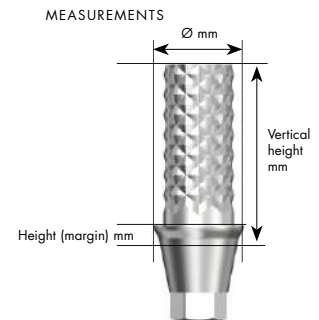

SHORT FACTS
Recommended torque for
temporization – 15 Ncm.

Temporary Abutment 3.5/4.0

Titanium

Includes Abutment Screw Design
3.5/4.0 – M1.6, REF 24449
(Titanium)
NI = Non Indexed



Ø mm	4.1	4.1
Height (margin) mm	1	1
Vert. height mm	9	9
REF	24281	24280

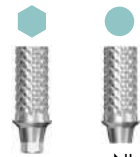

Temporary Abutment 4.5/5.0

Titanium

Includes Abutment Screw Design
4.5/5.0 – M2, REF 24209
(Titanium)



Ø mm	4.5	4.5
Height (margin) mm	1	1
Vert. height mm	9	9
REF	25015	25016



Components for cement-retained restorations



Optimal function and long-lasting esthetics

The restorative assortment for cement-retained solutions covers everything you need in order to create optimal function and natural long-lasting esthetics.

The assortment includes a wide range of abutments in order to successfully meet every clinical indication. The components are designed to give optimal treatment results for single, partial and full jaw bridge restorations.

The absolute top-of-the-line when it comes to cement-retained restorations is ATLANTIS – CAD/CAM designed patient-specific abutments for all major implant systems.

The ATLANTIS abutment is available in different materials, such as titanium, gold-shaded titanium, white and shaded zirconia. For more information about ATLANTIS abutment, please contact your local sales representative or visit www.dentsplyimplants.com.

CEMENT-RETAINED RESTORATIONS

Cement-retained abutments

MEASUREMENTS

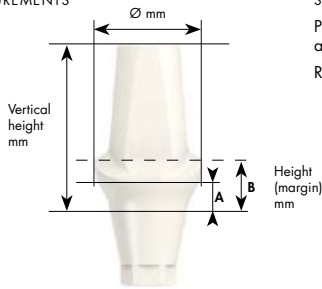

SHORT FACTS

Pre-designed for quick and easy adjustment.

Recommended torque – ● 20 Ncm
● 25 Ncm

ZirDesign™ 3.5/4.0

Zirconia

Includes Abutment Screw Design 3.5/4.0 – M1.6, REF 24449 (Titanium)



Angulation					20°
Ø mm	4.5	4.5	5.5	5.5	5.5
Height bucc A mm	1.5	3	1.5	3	3.5
ling B mm	2.5	4	2.5	4	3.5
Vert. height mm	9	10	9	10	9.5
REF	24702	24703	24704	24705	24706



ZirDesign™ 4.5/5.0

Zirconia

Includes Abutment Screw Design 4.5/5.0 – M2, REF 24209 (Titanium)



Angulation					20°
Ø mm	5.5	5.5	6.5	6.5	5.5
Height bucc A mm	1.5	3	1.5	3	3.5
ling B mm	2.5	4	2.5	4	3.5
Vert. height mm	9	10	9	10	9.5
REF	24707	24708	24709	24710	24711



MEASUREMENTS

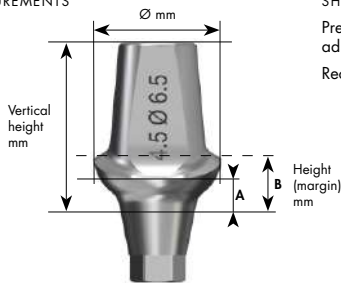

SHORT FACTS

Pre-designed for quick and easy adjustment.

Recommended torque – ● 15 Ncm
● 20 Ncm
● 25 Ncm

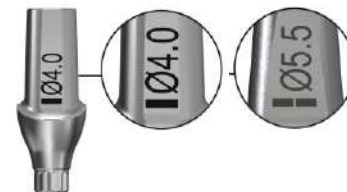

Marked with lines to identify connection size
3.0 – marked with one line.
3.5/4.0 – marked with two lines.
Marked with digits to identify diameter (Ø) and height.

TiDesign™ 3.0

Titanium

Includes Abutment Screw 3.0 – M1.4, REF 24189 (Titanium)



Angulation			15°
Ø mm	4.0	4.0	4.0
Height bucc A mm	1	2	2.4
ling B mm	1.5	2.5	2.4
Vert. height mm	7	8	7
REF	24788	24789	24790



Cement-retained abutments

TiDesign™ 3.5/4.0

Titanium

Includes Abutment Screw Design
3.5/4.0 – M1.6, REF 24449
(Titanium)



Angulation								20°	20°
Ø mm	4.5	4.5	5.5	5.5	6.5	6.5		4.5	5.5
Height bucc A mm	1.5	3	1.5	3	1.5	3		3.5	3.5
ling B mm	2.5	4	2.5	4	2.5	4		3.5	3.5
Vert. height mm	9	10	9	10	9	10		9.5	9.5
REF	24285	24286	24287	24288	24289	24290		24291	24292



TiDesign™ 4.5/5.0

Titanium

Includes Abutment Screw Design
4.5/5.0 – M2, REF 24209
(Titanium)



Angulation								20°	
Ø mm	5.5	5.5	6.5	6.5	5.5				
Height bucc A mm	1.5	3	1.5	3	3.5				
ling B mm	2.5	4	2.5	4	3.5				
Vert. height mm	9	10	9	10	9.5				
REF	24235	24236	24237	24238	24239				



CastDesign™ 3.5/4.0

Base: Non-oxidizing gold alloy
Cylinder: Burnout plastic

Includes Abutment Screw Design
3.5/4.0 – M1.6, REF 24449
(Titanium)



Ø mm	4.1
Height (margin) mm	1
Vert. height mm	10
REF	22843

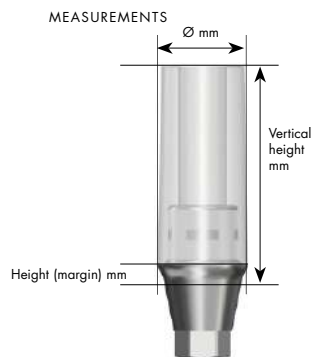

SHORT FACTS

Recommended torque – ● 20 Ncm
● 25 Ncm

CastDesign™ 4.5/5.0

Base: Non-oxidizing gold alloy
Cylinder: Burnout plastic

Includes Abutment Screw Design
4.5/5.0 – M2, REF 24209
(Titanium)



Ø mm	4.5
Height (margin) mm	1
Vert. height mm	10
REF	22844



CEMENT-RETAINED RESTORATIONS

Impression & laboratory components

Implant Pick-up 3.0, 3.5/4.0, 4.5/5.0

Titanium
NI = Non Indexed

Two piece component:
includes pick-up and guide pin.

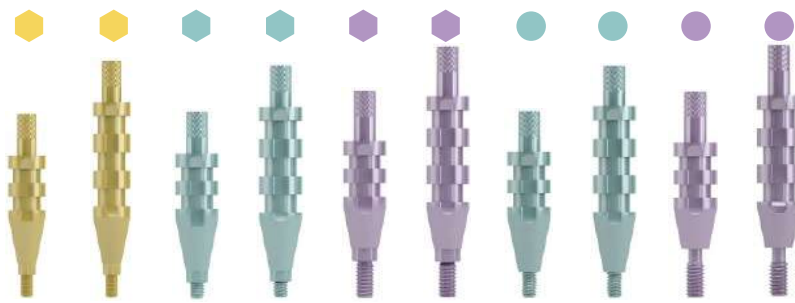

Length mm	21	26	21	26	22	27	21	26	22	27
REF	24950	24949	24947	24948	24938	24946	24936	24937	24928	24929

Implant Transfer 3.0, 3.5/4.0, 4.5/5.0

Titanium

Internal thread.
Two piece component:
includes sleeve and pin.



Product	Long	Short	Long	Short	Long
Length mm	19	16	19	18	21
REF	24958	24959	24960	24956	24957

Implant Replica 3.0, 3.5/4.0, 4.5/5.0

Titanium



Length mm	15	15	15.5
REF	24977	24978	24979

Implant Guide Pin 3.0, 3.5/4.0, 4.5/5.0

Titanium

Used when working with abutments
tightened with
Abutment screw – M1.4
Abutment screw – M1.6
Abutment screw – M2



Length mm	21	26	21	26	22	27
REF	24970	24976	24968	24969	24966	24967

MEASUREMENTS



SHORT FACTS

6 degree tapered top cone.
 Laser marked line for simplified occlusal reduction at 1 mm line.
 Recommended torque – ● 25 Ncm
 ● 25 Ncm
 Marked with digit to identify diameter (Ø).



Direct Abutment API™
3.5/4.0 ●

API = All parts included

Ø mm	Height (margin) mm	REF
4	0.5	24917
4	1	24918
4	2.5	24919
4	4	24920



DA 4 Metal Carrier for seating and retrieval of Direct Abutment Ø 4, see pages 20 and 51.

Ø mm	Height (margin) mm	REF
5	1	24921
5	2.5	24922
5	4	24923



Direct Abutment API™
4.5/5.0 ●

Ø mm	Height (margin) mm	REF
5	0.5	24558
5	1	24559
5	2.5	24560
5	4	24561



Ø mm	Height (margin) mm	REF
6	1	24562
6	2.5	24563
6	4	24564



CEMENT-RETAINED RESTORATIONS

Direct Abutment™ & separate items

Direct Abutment™ 3.5/4.0

Titanium

Ø mm	4	4	4	4	5	5	5
Height (margin) mm	0.5	1	2.5	4	1	2.5	4
Vert. height mm	6	6	8	9	6	8	9
REF	24910	24911	24912	24913	24914	24915	24916

Direct Abutment™ 4.5/5.0

Titanium

Ø mm	5	5	5	5	6	6	6
Height (margin) mm	0.5	1	2.5	4	1	2.5	4
Vert. height mm	6	6	8	9	6	8	9
REF	24527	24528	24529	24530	24537	24538	24539

Direct Abutment™ Healing Cap

Plastic

Ø mm	4	5	6
REF	22720	22721	22722

Direct Abutment™ Impression Pick-up

Plastic

Ø mm	4	5	6
REF	22710	22711	22712

Direct Abutment™ Replica

Stainless steel

Ø mm	4	5	6
REF	22054	22064	22065

Direct Abutment™ Burnout Cylinder

Plastic

Ø mm	4	5	6
REF	22372	22373	22379

Direct Abutment™ Carrier

Plastic/Stainless steel

DA 4 Metal Carrier for seating and retrieval of Direct Abutment Ø 4, see also page 51.

Ø mm	4	5	6	4
REF	24137	24138	24139	22850

Components for screw-retained restorations

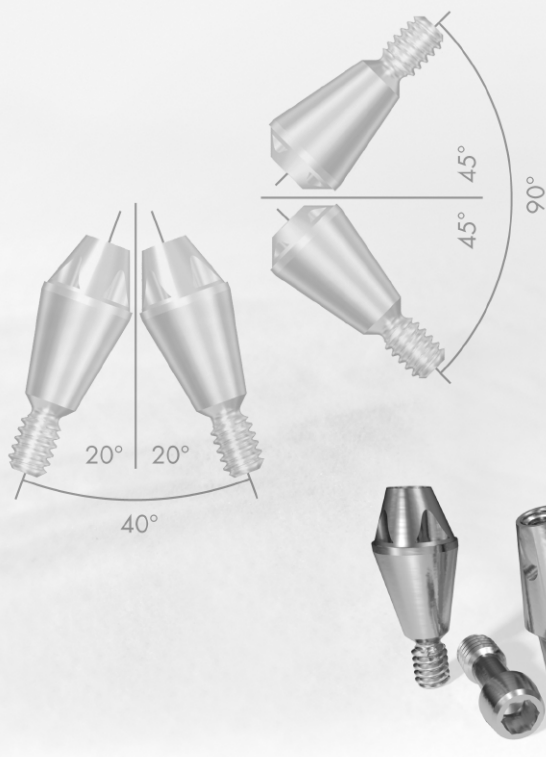

Well documented solutions for predictable clinical success

For screw-retained restorations, the ASTRA TECH Implant System provides abutments for all treatment indications. The components are designed for full flexibility and optimal results for partial as well as full jaw restorations. The UniAbutment, with its conical abutment top supporting the restoration, provide mechanical, clinical and biological support. The flexibility for implants placed in non-parallel positions with limited vertical space available, provides freedom and satisfaction for each clinician.



ATLANTIS ISUS implant suprastructures are the benchmark for fixed and removable dental prostheses. The suprastructures are produced using the latest developments in CAD/CAM technology, and milled from solid blocks of titanium or cobalt-chrome.

ATLANTIS ISUS offers an expansive range of flexibility in therapy and design options, with CAD/CAM precision that provides a tension-free fit. Available for the major implant systems, ATLANTIS ISUS offers bars, bridges, hybrids and unique 2in1 solutions.

For more information, please contact your local sales representative, or visit www.dentsplyimplants.com

SCREW-RETAINED RESTORATIONS

UniAbutment

MEASUREMENTS

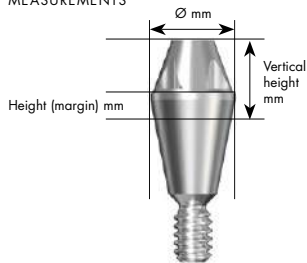

SHORT FACTS

Height of 20° tapered top cone – 2.15 mm.
 Height of 45° tapered top cone – 0.8 mm.
 Removal grooves.
 Pre-mounted with carrier.
 Recommended torque – 15 Ncm.



20° UniAbutment 3.5/4.0

Titanium, Sterile

20° tapered top



Ø mm	3.5	3.5	3.5	3.5	3.5	3.5
Height (margin) mm	0.5	1	2	4	6	8
Vert. height mm	2.5	3	4	6	8	10
REF	24893	24894	24895	24896	24897	24898

45° UniAbutment 3.5/4.0

Titanium, Sterile

45° tapered top



Ø mm	3.5	3.5	3.5	3.5	3.5	3.5
Height (margin) mm	0.5	1	2	4	6	8
Vert. height mm	1	2	3	5	7	9
REF	24899	24900	24901	24902	24903	24904

20° UniAbutment 4.5/5.0

Titanium, Sterile

20° tapered top



Ø mm	3.5	3.5	3.5	3.5	3.5	3.5
Height (margin) mm	0.5	1	2	4	6	8
Vert. height mm	2.5	3	4	6	8	10
REF	24398	24399	24400	24401	24402	24403

45° UniAbutment 4.5/5.0

Titanium, Sterile

45° tapered top



Ø mm	3.5	3.5	3.5	3.5	3.5	3.5
Height (margin) mm	0.5	1	2	4	6	8
Vert. height mm	1	2	3	5	7	9
REF	24406	24407	24408	24409	24410	24411







Easy to remove the UniAbutment/Cresco Insert with Removal Tool M1.4, see page 51.

Angled Abutment 3.5/4.0



Titanium, Sterile

Angulation 20°
Includes Abutment Screw Angled
3.5/4.0 – M1.6, REF 24439
(Titanium)

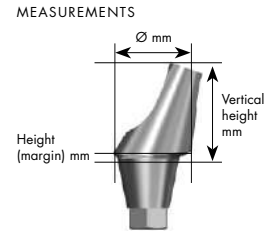

				
Ø mm	4	4	4	4
Height (margin) mm	0.8	2	0.8	2
Vert. height mm	6	7	6	7
REF	24245	24246	24347	24348







SHORT FACTS
Recommended torque –  20 Ncm
 25 Ncm

Angled Abutment 4.5/5.0

Titanium, Sterile

Angulation 20°
Includes Abutment Screw Angled
4.5/5.0 – M2, REF 22487
(Titanium)



				
Ø mm	4	4	4	4
Height (margin) mm	0.5	2	0.5	2
Vert. height mm	6	7	6	7
REF	24247	24248	24606	24607

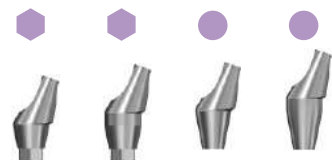

20° ProHeal Cap

Titanium, Sterile

Healing cap
for 20° UniAbutments.

			
	Short	Short	Long
Ø mm	4.3	5.5	5.5
Height mm	4	3.8	5.8
REF	24162	24158	24159

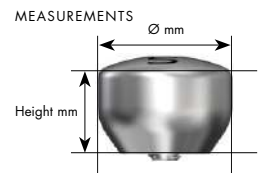



SHORT FACTS
Recommended torque – Manual.
Only light fingerforce (5–10 Ncm)
using a manual hex screwdriver.
Do not use a Ratchet or Torque
Wrench.

45° ProHeal Cap

Titanium, Sterile

Healing cap for 45° UniAbutments
and 45° Cresco Insert.

			
	Short	Short	Long
Ø mm	4.3	5.5	5.5
Height mm	2.7	3.8	5.8
REF	24163	24160	24161

Healing Cap Angled

Titanium, Sterile

Includes Bridge Screw, Slot, REF 22167



	
Ø mm	5
Height mm	7.5
REF	24092

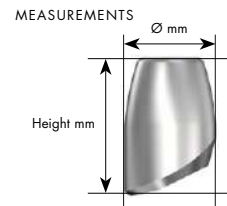

SHORT FACTS
Recommended torque – Manual.

SCREW-RETAINED RESTORATIONS

Impression & laboratory components

20° UniAbutment Pick-up

Stainless steel

Two piece component: pick-up and guide pin.

Ø mm	4.3	5.5
REF	22882	22876



45° UniAbutment Pick-up

Stainless steel

Two piece component: pick-up and guide pin.

Ø mm	4.3	5.5
REF	22883	22878



20°/45° UniAbutment Transfer

Stainless steel

Used for 20° and 45° UniAbutment.
When using transfer, information on which abutment used must be communicated to the lab.

REF 22068



Angled Abutment Pick-up

Stainless steel

Two piece component: pick-up and guide pin.

REF 24254



Abutment Replica

Stainless steel

Product	Uni 20°	Uni 45°	Angled
REF	22069	22070	24227



Abutment Guide Pin, M1.4

Stainless steel



Length mm	13	16	19	22
REF	22190	22197	22198	22199



Bridge Screw, M1.4

Titanium

Recommended torque is 1.5 Ncm.

		
	Hex	Slot
Screw head Ø mm	2.3	2.3
Head depth mm	1.8	1
REF	22435	22167

Temporary Cylinder

Titanium

			
	Uni 20°	Uni 45°	Angled
REF	22060	22061	22447

Semi-Burnout Cylinder

Base: Non-oxidizing gold alloy
Cylinder: Plastic

			
	Uni 20°	Uni 45°	Angled
REF	22184	22185	24243

Burnout Cylinder

Plastic

			
	Uni 20°	Uni 45°	Angled
REF	22186	22187	22448

Titanium Cylinder

Base: Titanium
Cylinder: Plastic

			
	Uni 20°	Uni 45°	Angled
REF	22798	22799	24244

SCREW-RETAINED RESTORATIONS

Cresco API™

MEASUREMENTS

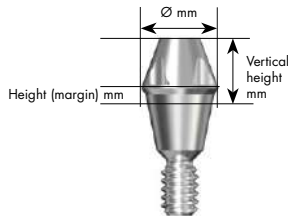

SHORT FACTS

Height of 20° tapered top cone – 2.15 mm.
 Height of 45° tapered top cone – 0.8 mm.
 Removal grooves.
 Pre-mounted with carrier.
 Recommended torque – 15 Ncm.

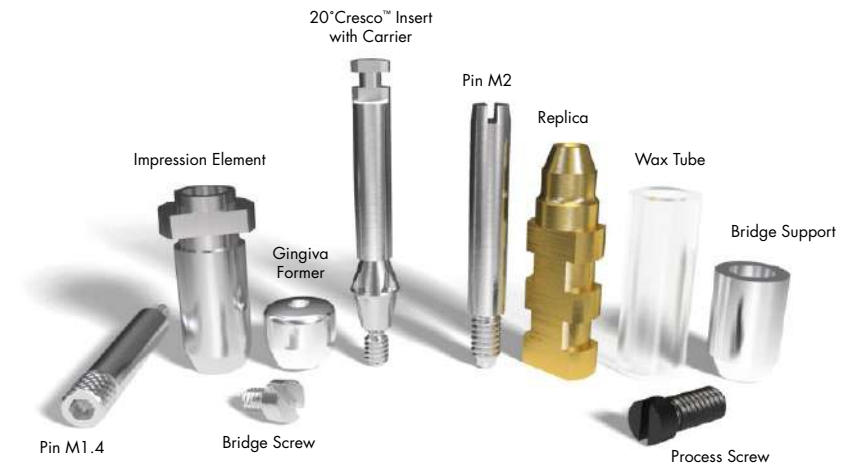

■ PROSTHETIC COMPONENTS

■ LABORATORY COMPONENTS

Cresco API™ 3.5/4.0 ●

API = All Parts Included

Includes Bridge Support in

	Ø mm	Height (margin) mm	Vert. height mm
20° Cresco Insert	3.3	0.5	2.5
	3.3	2	4.0
45° Cresco Insert	3.3	0.7	1.5
	3.3	2	2.8



Titanium	Burnout	Cobalt-Chrome
REF	REF	REF
30351	30551	30851
30352	30552	30852
30353	30553	30853
30354	30554	30854

Cresco API™ 4.5/5.0 ●

Includes Bridge Support in

	Ø mm	Height (margin) mm	Vert. height mm
20° Cresco Insert	3.5	0.5	2.5
	3.5	2	4.0
45° Cresco Insert	3.5	0.7	1.5
	3.5	2	2.8



Titanium	Burnout	Cobalt-Chrome
REF	REF	REF
30312	30512	30812
30322	30522	30822
30305	30505	30805
30310	30510	30810

Components for Attachment-retained restorations

Attached to implants

There are several indications for overdenture treatment in connection with implant therapy. Functional, esthetic, phonetic and hygienic requirements in certain clinical situations support the use of the overdenture as a treatment option. The presence of at least one implant in each quadrant of the jaw, combined with a suitable attachment system, makes overdenture treatment a viable alternative when treating totally edentulous jaws.



ATTACHMENT-RETAINED RESTORATIONS

Locator™ abutments

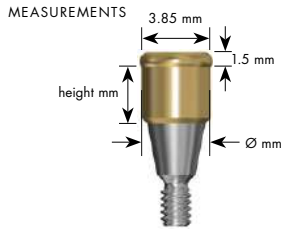

SHORT FACTS

Diameter of Locator retention top – 3.85 mm.
1.5 mm of the top should be supragingival to be able to retain the overdenture.

Recommended torque – ● 25 Ncm
● 25 Ncm

Locator™ Abutment 3.5/4.0

Titanium
TiN-coating



Ø mm

Height mm

REF

Ø mm	3.7	3.7	3.7	3.7	3.7
Height mm	1	2	3	4	5
REF	24268	24269	24270	24271	24272

Locator™ Abutment 4.5/5.0

Titanium
TiN-coating



Ø mm

Height mm

REF

Ø mm	3.7	3.7	3.7	3.7	3.7
Height mm	0.5	2	3	4	5
REF	24477	24478	24479	24480	24481

Locator™ Abutment Pick-up

Aluminum
QTY 4

REF 24484



Locator™ Abutment Replica

Aluminum
QTY 4

REF 24485



Locator™ Process Kit

QTY 2 sets

REF 24483



Locator™ Inserts

Plastic

QTY 4

*For nonparallel implants

REF

Grams



	Blue	Pink	Clear	Red	Green
REF	24488	24487	24486	24492*	24489*
Grams	680	1361	2268	226-680	1361-1814

Locator™ Core Tool

Stainless steel

REF 24482



Locator™ Torque Wrench Bit

Stainless steel

Used in combination with Torque Wrench.

REF



15 mm

21 mm

24490

24491

MEASUREMENTS

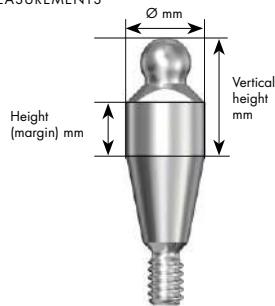

SHORT FACTS

Height of the ball from the margin – 2.85 mm.
Installed using Ball Wrench, REF 24367.

Recommended torque – ● 25 Ncm
● 25 Ncm

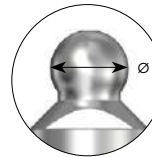

Diameter of the ball – 2.25 mm.

Ball Abutment 3.5/4.0

Titanium, Sterile

Ball Ø 2.25 mm



Ø mm

Height (margin) mm

Vert. height mm

REF

Ø mm	3.5	3.5	3.5	3.5	3.5
Height (margin) mm	1	2	4	6	8
Vert. height mm	4	5	7	9	11
REF	24905	24906	24907	24908	24909

Ball Abutment 4.5/5.0

Titanium, Sterile

Ball Ø 2.25 mm



Ø mm

Height (margin) mm

Vert. height mm

REF

Ø mm	3.5	3.5	3.5	3.5	3.5	3.5
Height (margin) mm	0.5	1	2	4	6	8
Vert. height mm	3.5	4	5	7	9	11
REF	24418	24419	24420	24421	24422	24423

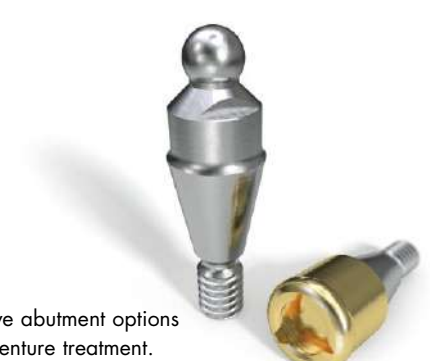

Restorative abutment options for overdenture treatment.

ATTACHMENT-RETAINED RESTORATIONS

Ball Abutment

Ball Abutment Pick-up

Plastic

REF 22439



Ball Abutment Replica

Stainless steel

REF 22505



Clix Female

Titanium and plastic

O-ring spacer included.

REF 22383



Clix Inserts

Plastic

REF 22384

QTY 6 (2 of each)

Grams



750

1150

1500

Ball Housing

Gold Alloy

O-ring spacer pre-mounted.

REF 22364



Ball Wrench

Stainless steel

Wrench for seating and retrieval of Ball Abutment. Used together with Ratchet Wrench, Torque Wrench or Surgical Wrench.

REF 24367



Clix Insertion Tool

Stainless steel

REF 22385



Activator/Deactivator, Ball Housing

Stainless steel

REF



Activator
22366

Deactivator
22365

Paralleling Mandrel, Female

Stainless steel

REF 22371

Used for Clix Female and Ball Housing.





SHORT FACTS

The following components should be utilized with UniAbutments (see page 23).

Profile Bar System

Used in combination with UniAbutment and Semi-Burnout Cylinder.

REF 22381

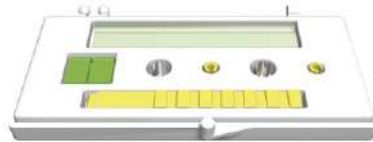

Profile Bar Insert

Plastic

QTY 6 (2 of each)

REF 22382



Grams

700

1100

1500

OD Cylinder

Gold Alloy

Used in combination with UniAbutment and bridge screw slot.

REF



Uni 20°

22182



Uni 45°

22183

Round Bar

Gold Alloy

Includes Tin spacer

REF 22362



Rider, Round Bar

Gold Alloy

REF 22363



Surgical instruments

Getting started

If you are new to the ASTRA TECH Implant System, we recommend the following instruments to get started:

Surgical Instrument Kit, REF 24980 – see page 33

Surgical Tray, REF 24349 – see page 33

Ratchet Wrench, REF 24357 – see page 34

and your choice of:

Single Patient drills – see page 38

Multiple-use drills – see pages 40–41

ALTERNATIVE – for use with Single Patient Drills only:

Surgical Instrument Kit, REF 24980 – see page 33

Restorative Tray, REF 22495 – see page 45

Ratchet Wrench, REF 24357 – see page 34

Your choice of Single Patient drills, see page 39.



Surgical Instrument Kit

Surgical Instrument Kit Includes:

Direction Indicator 2.0/3.2	(4)	22434
Implant Depth Gauge 6–19 mm	(1)	24801
Implant Driver 3.5/4.0, Short	(1)	25009
Implant Driver 3.5/4.0, Long	(1)	25010
Implant Driver 4.5/5.0, Short	(1)	25011
Implant Driver 4.5/5.0, Long	(1)	25012
Hex CA Driver, Short	(1)	22548
Hex CA Driver, Long	(1)	22549
Drill Extension	(1)	22520
Driver Handle	(1)	24358

REF 24980



Note: Does not include implant drivers for 3.0 implant.

Surgical Tray

No instruments included.

REF 24349

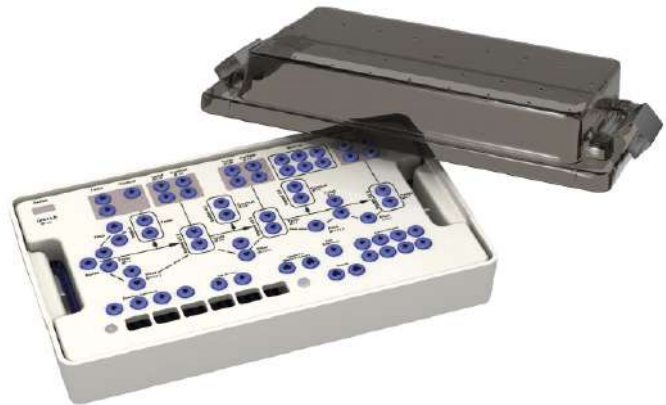

Implant Driver 3.0



Short, 19 mm
REF 25007



Long, 28 mm
REF 25008



Implant Driver 3.5/4.0



Short, 19 mm
REF 25009



Long, 28 mm
REF 25010



Implant Driver 4.5/5.0



Short, 20 mm
REF 25011



Long, 28 mm
REF 25012



Used to engage and place implants.

Short drivers are ideal for the posterior region.

SURGICAL INSTRUMENTS

Ratchet Wrench

Stainless steel

Wrench without torque function.

REF 24357



Driver Handle

Stainless steel

Used in combination with Ratchet Wrench and/or machine/contra angle (CA) instruments.

REF 24358



Wrench Adapter

Stainless steel

For handling of Implant Drivers. Only needed for customers who already have Surgical Wrench (REF 24178) or Torque Wrench (REF 24075).

REF 24572



Direction Indicator 2.0/3.2

Titanium

For use after 2.0 mm and/or 3.2 mm Twist Drill.

REF 22434



Titanium Bowl

Titanium

REF 22137



Implant Depth Gauge, 6–19 mm

Titanium

Laser etched bands for measuring of implant and soft tissue heights.
Waist at 13–15 mm indication.

REF 24801



Periotome

Titanium

For atraumatic tooth extraction.

Posterior
Curved/straight edge
REF 24274



Anterior
Curved/straight edge
REF 24275



Wrench

Titanium

Use together with any adapter and/or retriever.

REF 22124



Forceps

Titanium

94 mm
REF 22437



Hex Screwdriver

Stainless steel

Hexagonal screwdriver.

Short, 20 mm
REF 22514



Intermediate, 31 mm
REF 22515



Long, 43 mm
REF 22516



Hex CA Driver

Stainless steel

Hexagonal screwdriver for Contra Angle and/or Driver Handle.

Short, 24 mm
REF 22548



Long, 35 mm
REF 22549



SURGICAL INSTRUMENTS

Osteotome Kit

Stainless steel

REF 22956

Astra Tech Osteotome Kit includes:

Osteotome Tray, Large	(1)	22953
Osteotome Set, Round	(1)	22937
Osteotome Set, Concave	(1)	22947
Osteotome Mallet, Small	(1)	22955

Note: Does not include Osteotomes for 5.0 S implants.



Osteotome Set, Round, Straight

Stainless steel

REF 22937

Seven straight instruments with round tips.

Also available as separate items.

Osteotome 2.0/2.5, Round, Straight	(1)	22930
Osteotome 2.5/3.2, Round, Straight	(1)	22931
Osteotome 3.2, Round, Straight	(1)	22932
Osteotome 3.2/3.7, Round, Straight	(1)	22933
Osteotome 3.7, Round, Straight	(1)	22934
Osteotome 3.2/4.3, Round, Straight	(1)	22935
Osteotome 3.7/4.8, Round, Straight	(1)	22936

Note: Does not include Osteotomes for 5.0 S implants.



Osteotome Set, Concave, Bayonet

Stainless steel

REF 22947

Seven bayonet shaped instruments with concave tips. Also available as separate items.

Osteotome 2.0/2.5, Concave, Bayonet	(1)	22940
Osteotome 2.5/3.2, Concave, Bayonet	(1)	22941
Osteotome 3.2, Concave, Bayonet	(1)	22942
Osteotome 3.2/3.7, Concave, Bayonet	(1)	22943
Osteotome 3.7, Concave, Bayonet	(1)	22944
Osteotome 3.2/4.3, Concave, Bayonet	(1)	22945
Osteotome 3.7/4.8, Concave, Bayonet	(1)	22946

Note: Does not include Osteotomes for 5.0 S implants.



Osteotome Mallet, Small

Stainless steel

REF 22955



Osteotome Set 5.0 S, Round, Straight

Stainless steel

REF 24687

Four straight instruments with round tips.
Also available as separate items.



Osteotome 3.7/4.2, Round, Straight	24339
Osteotome 4.2, Round, Straight	24684
Osteotome 4.2/4.7, Round, Straight	24685
Osteotome 4.7, Round, Straight	24686

Osteotome Set 5.0 S, Concave, Bayonet

Stainless steel

REF 24692

Four bayonet shaped instruments with concave tips. Also available as separate items.



Osteotome 3.7/4.2, Concave, Bayonet	24688
Osteotome 4.2, Concave, Bayonet	24689
Osteotome 4.2/4.7, Concave, Bayonet	24690
Osteotome 4.7, Concave, Bayonet	24691

Osteotome Tray, Large

Stainless steel

REF 22953

No instruments included.
Room for 14 osteotomes.



Osteotome Tray, Small

Stainless steel

REF 24693

No instruments included.
Room for 7 osteotomes.



DRILLS

Single Patient drills

Single Patient Drill Kits

Stainless steel

Sterile

Laser etched depth indication.

Includes:

Guide Drill

SP Twist Drill Ø 2.0

SP Twist Drill Ø 3.2



Short, 8–13 mm
REF 22898



Long, 8–19 mm
REF 22899

Single Patient Drill Kit 6–13 mm

Stainless steel

Sterile

Laser etched depth indication.

Includes:

SP Twist Drill Ø 2.0, 6–13 mm

SP Twist Drill Ø 3.2, 6–13 mm

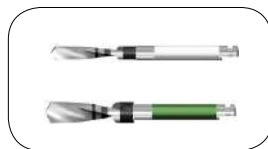

REF 24737*









































Note: SP Drills included in kits are not available as separate items.

*For OsseoSpeed TX 4.0 S – 6 mm



Single Patient Drills

Stainless steel
Sterile
Laser etched depth indication.

	REF				
SP Twist Drill Ø 3.7, 6–13 mm	24199*				
SP Twist Drill Ø 3.85, 6–13 mm	24734*				
	REF	Short 8–13 mm	REF	Long 8–19 mm	
SP Twist Drill Ø 2.0	24992		24991		
SP Twist Drill Ø 2.7	24994		24993		
SP Twist Drill Ø 2.85	24996		24995		
SP Twist Drill Ø 3.35	22908		22909		
SP Twist Drill Ø 3.7	22910		22911		
SP Twist Drill Ø 3.85	22912		22913		
SP Twist Drill Ø 4.2	22957		22958		
SP Twist Drill Ø 4.7	22959		22960		
SP Twist Drill Ø 4.85	22961		22962		
	REF	Short shaft	REF	Long shaft	
SP Pilot Drill Ø 2.0/3.2, 6–13 mm	24735*				
SP Pilot Drill Ø 2.0/2.7	24997				
SP Pilot Drill Ø 2.0/3.2	22904		22905		
SP Pilot Drill Ø 3.2/3.7	22906		22907		
SP Pilot Drill Ø 3.7/4.2	22963				
SP Cortical Drill Ø 2.7/3.0	24998				
SP Cortical Drill Ø 3.2/3.5	22914		22915		
SP Cortical Drill Ø 3.7/4.0	22916		22917		
SP Cortical Drill Ø 4.7/5.0	22964				
SP Conical Drill Ø 2.7/4.5	24999		25000		
SP Conical Drill Ø 3.2/4.5	22921		22922		
SP Conical Drill Ø 3.2/5.0	25001		25002		
SP Conical Drill Ø 3.7/5.0	22923		22924		

*For OsseoSpeed TX 4.0 S – 6 mm

DRILLS

Multiple-use drills

Drill Set

Stainless steel, TiN-coated
Laser etched depth indication.

Starter set of drills.

*Does not include drills for 3.0 S,
4.0 S – 6 mm or 5.0 S.

REF 24264



Guide Drill

Stainless steel

Guide Drill Ø 1.8

REF 22800



Twist Drill

Stainless steel, TiN-coated
Laser etched depth indication.





Note: *Not included in Drill Set, REF 24264

	REF	Short, 8–13 mm	REF	Long, 8–19 mm
Twist Drill Ø 2.0, (no color)	22887		22886	
Twist Drill Ø 2.5, (red)	22802		22801	
Twist Drill Ø 2.7, (light blue)	24797*		24796*	
Twist Drill Ø 2.85, (silver)	24799*		24798*	
Twist Drill Ø 3.2, (green)	22811		22807	
Twist Drill Ø 3.35, (lilac)	22812		22808	
Twist Drill Ø 3.7, (black)	22813		22809	
Twist Drill Ø 3.85, (brown)	22814		22810	
Twist Drill Ø 4.2, (yellow)	22463*		22462*	
Twist Drill Ø 4.7, (blue)	22465*		22464*	
Twist Drill Ø 4.85, (pink)	22467*		22466*	

Pilot Drill

Stainless steel, TiN-coated
Laser etched depth indication.





Note: *Not included in Drill Set, REF 24264

	REF	
Pilot Drill Ø 2.0/2.7 (light blue)	24795*	
Pilot Drill Ø 2.0/3.2 (green)	24207	
Pilot Drill Ø 2.5/3.2 (green)	22803	
Pilot Drill Ø 3.2/3.7 (black)	22805	
Pilot Drill Ø 3.7/4.2 (yellow)	22468*	

Cortical Drill

Stainless steel, TiN-coated
Laser etched depth indication.









Note: *Not included in Drill Set, REF 24264

	REF	
Cortical Drill Ø 2.7/3.0 (light blue)	24800*	
Cortical Drill Ø 3.2/3.5 (green)	22815	
Cortical Drill Ø 3.7/4.0 (black)	22816	
Cortical Drill Ø 4.7/5.0 (blue)	22469*	

Conical Drill

Stainless steel, TiN-coated
Laser etched depth indication.

Note: *Not included in Drill Set, REF 24264

	REF	Short shaft	REF	Long shaft
Conical Drill Ø 2.7/4.5 (light blue)	24924*		24925*	
Conical Drill Ø 3.2/4.5 (green)	22894		22895	
Conical Drill Ø 3.2/5.0 (no color)	24926*		24927*	
Conical Drill Ø 3.7/5.0 (black)	22896		22897	

Drill Extension

Stainless steel

REF
22520



Implant Unit

Implant unit includes:

- Control unit
- Foot Control
- Motor with 1.8 m cable including 5 clips
- Main Cable
- Motor Support
- Stand
- Locking Pins
- Protection cap for motor
- Irrigation tubing (QTY 3), disposable for single patient use.

Note: Contra Angle must be purchased separately.



Implant Unit SI 915, 115 V REF 24360
Implant Unit SI 923, 230 V REF 24412

Contra Angles

20:1 Contra Angle for Implant Unit and for ImplantMED Drill Unit.
Can be dismantled.

Note: Be sure to pay attention to the correct contra angle adjustment of your drive unit.



W&H WS-75 E/KM REF 22903

20:1 Contra Angle for Implant Unit and for ImplantMED Drill Unit.
Can not be dismantled.

Note: Be sure to pay attention to the correct contra angle adjustment of your drive unit.



W&H WI-75 E/KM REF 24350

Irrigation Set

Disposable Irrigation Set, W&H
Includes pump segment. 2.2 m,
sterile for ImplantMED
and recommended for
Implant Unit.
QTY 6



REF 22176

Irrigation Tube

Irrigation Tube, W&H, disposable 2.2 m, sterile for ElcoMED 100 and ImplantMED. QTY 10

REF 22177



Suction Tube

Medena
 Ø 5.5 mm/8 mm, 2.0 m, QTY 100
 Single-use, sterile.

REF 68108



Medena
 Ø 5.5 mm/8 mm, 3.5 m, QTY 70
 Single-use, sterile.

REF 68130

Medena
 Ø 5.5 mm/8 mm, 2.0 m, QTY 100
 Including double bent suction tip.
 Single-use, sterile.

REF 68118



Mucosal Punch

For manual use.
 Single-use, sterile.

Ø 4.0, QTY 10
 REF 22131
 Ø 5.0, QTY 10
 REF 22552



RA Mucosal Punch 3.5/4.0

Stainless steel

For contra angle use.

●
 REF 31267



RA Mucosal Punch 4.5/5.0

Stainless steel

For contra angle use.

●
 REF 24803



BoneTrap™

BoneTrap is the ideal collector for harvesting bone particles during surgery. The unique design of the filter allows for efficient collection of bone particles without clogging. BoneTrap is disposable and provided sterile. QTY 10

REF 22179



Restorative instruments

Getting started

If you are new to the ASTRA TECH Implant System, we recommend the following prosthetic instruments to get started:

Restorative Instrument Kit, REF 24879 – see page 45

Restorative Tray, REF 22495 – see page 45

Torque Wrench Kit, REF 24100 – see page 45



Restorative Instrument Kit

Restorative Instrument Kit Includes:

		REF	
Driver Handle	(1)	24358	
Abutment Depth Gauge	(1)	24573	
Hex CA Driver, short	(1)	22548	
Hex CA Driver, long	(1)	22549	REF 24879



Restorative Tray

Tray with room to host all restorative instruments. No instruments included.

REF 22495



Torque Wrench Kit

Wrench with adjustable torque function.
Range 10, 15, 20 and 25 Ncm.

		REF	
Torque Wrench	(1)	24075	
T.W. Bit Hex, Short	(1)	24093	
T.W. Bit Hex, Long	(1)	24094	
T.W. Bit Slot, Short	(1)	24095	
T.W. Bit Slot, Long	(1)	24096	
T.W. Conn., Adapter	(1)	24097	
T.W. Instrument Lubricant	(1)	24098	REF 24100
T.W. Dismantle Tool	(1)	24099	O-ring T.W. Bit (QTY 10) REF 22416

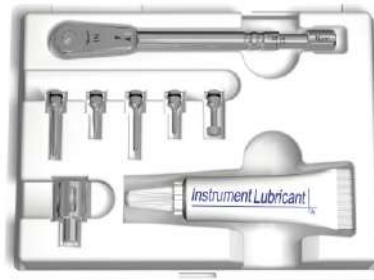

RESTORATIVE INSTRUMENTS

General

Try-in Kit Direct Abutment™

Plastic

Includes

Try-in Case Direct Abutment™

Direct Abutment™ 3.5/4.0 Try-in

Direct Abutment™ 4.5/5.0 Try-in

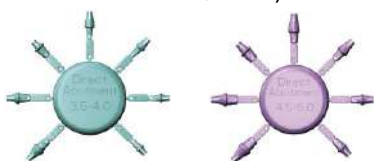

REF

24839

24848

24850

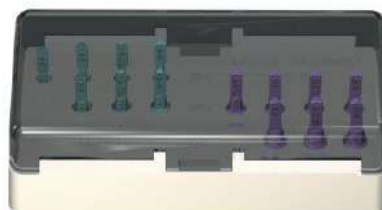

Try-in TiDesign™/ZirDesign™

Plastic

Includes

Try-in Case Ti/ZirDesign

Ti/ZirDesign™ 3.5/4.0 Try-in

Ti/ZirDesign™ 4.5/5.0 Try-in

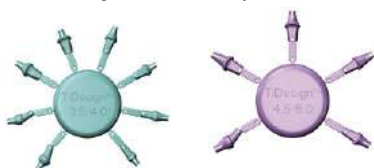

REF

24847

24849

Torque Wrench

Stainless steel

REF

24075



Hex Screwdriver

Stainless steel

Hexagonal screwdriver.

REF

Short, 20 mm

22514

Intermediate, 31 mm

22515

Long, 43 mm

22516

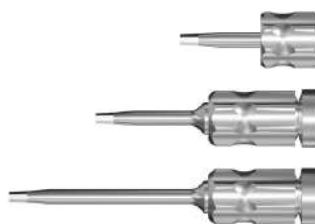

Hex CA Driver

Stainless steel

Hexagonal screwdriver for Contra Angle.

REF

Short, 24 mm

22548

Long, 35 mm

22549



Slot Screwdriver

Stainless steel

Short, 20 mm

Intermediate, 30 mm

Long, 43 mm

REF

22506

22507

22508

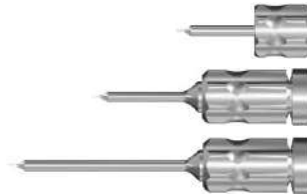

Slot CA Driver

Stainless steel

Slot screwdriver for Contra Angle.

Short, 24 mm

Long, 35 mm

REF

22688

22689



Abutment Depth Gauge

Stainless steel

Laser etched bands for measuring mucosal height over the implant in millimeters.

Waist at 4–5 mm indication, section for better visual orientation.

REF 24573

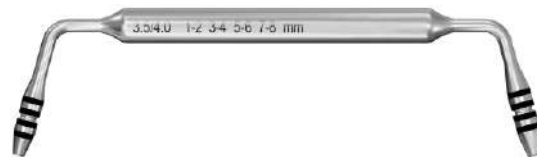

Handpiece Connector Carrier

Stainless steel

For connection between Contra Angle and pre-mounted Abutment Carrier on UniAbutments.

REF 24133



Carrier Extension

Stainless steel

For extended connection between pre-mounted Abutment Carrier and Torque Wrench.

Short
REF 24134



Long
REF 24135



O-ring (QTY 10) REF 22416

General







Lab Abutment Screw Design

Titanium

For all DesignLine abutments.

Separate sets, each set includes:

- 2 pcs Yellow
- 6 pcs Aqua
- 6 pcs Lilac

			
			
REF	24802	24857	24858
QTY	2 x M1.4	6 x M1.6	6 x M2

Lab Abutment Screw, Angled

Titanium

For Angled Abutment.

Set includes 4 pieces:

- 2 pcs Aqua
- 2 pcs Lilac

		
		
REF	24860	
QTY	2 x M1.6	2 x M2

Lab Bridge Screw, hex and slot

Titanium

Set includes 6 pieces:

- 3 slot screws
- 3 hex screws

		
REF	24859	
QTY	3 x M1.4	3 x M1.4

Grinding Handle

Use with implant replicas for grinding of abutments.

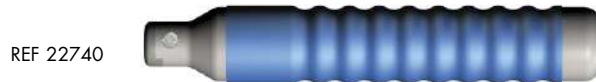

REF 22740

Grinding Device

For Cylinder 20° and Bridge Screw entrance hole.



Uni 20°
REF 22170

Cylinder, Bridge Hole
REF 22820

Polishing Protector

Stainless steel

QTY 10

For the internal cone and the margin of 20° and 45° cylinders. Works together with Bridge Screw or Abutment Guide Pin.

		
Product	Uni 20°	Uni 45°
REF	22471	22474

Cresco™ Slot Screwdriver

Stainless steel

	REF
15 mm	31274
26 mm	31252
34 mm	31253



Cresco™ RA Slot Screwdriver

Stainless steel

	REF
20 mm	31273
26 mm	31272
34 mm	31264



Driver Handle

Stainless steel

	REF
Used in combination with Ratchet Wrench and/or machine/contra angle (CA/RA) instruments.	24358



Cresco™ Torque Ratchet Wrench

Stainless steel

	REF
Torque Ratchet Wrench with individual adjustment of the torque to 15, 20 and 35 Ncm.	31276



Cresco™ Waxing Tool

Stainless steel

	REF
Used for bending Wax Tubes if angulation of screw access holes is needed.	31690



Cresco™ Slot Screwdriver

Stainless steel

	REF
Long	31254



Removal/Retrieval Kit

		REF
Abutment Adapter Long	(1)	24370
Abutment Adapter Short	(1)	24424
Fragment Fork, Thin, 1.0 mm	(1)	22122
Fragment Fork, Wide, 1.4 mm	(1)	22632
Implant Adapter M2 Long	(1)	24368
Implant Adapter M1.6 Long	(1)	24194
Implant Adapter M1.6 Short	(1)	24193
Implant Adapter M2 Short	(1)	24369
Implant Retriever	(1)	22192
Threads Taps 1.4 mm*	(1)	22871
Threads Taps 1.6 mm*	(1)	22873
Threads Taps 2.0 mm*	(1)	22875
Trephine Drill, Ø 3.5	(1)	22884
Trephine Drill, Ø 4.0	(1)	22885
Trephine Drill, Ø 5.0	(1)	22890
UniAbutment Retriever	(1)	22429
Wrench	(1)	22124

***Note:** For manual use only.

All included instruments also available as separate items.

REF 22864

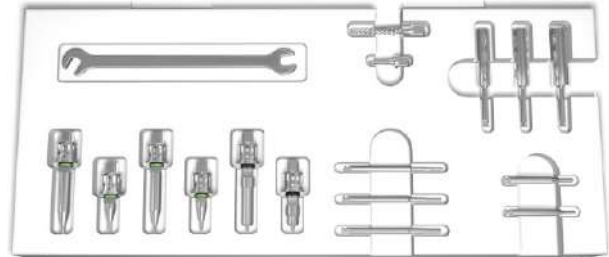

Implant Adapter M2

Titanium and Stainless steel

For removal of implants with 2 mm threading. Used together with Ratchet Wrench/Torque Wrench/Surgical Wrench or Wrench 22124.

Short, 24.5 mm
REF 24369



Long, 36 mm
REF 24368



O-ring, Implant Adapter, Plastic (QTY 10) REF 22375

Implant Adapter M1.6

Titanium and Stainless steel

For removal of implants with 1.6 mm threading. Used together with Ratchet Wrench/Torque Wrench/Surgical Wrench or Wrench 22124.

Short, 24.5 mm
REF 24193



Long, 36 mm
REF 24194



O-ring, Implant Adapter, Plastic (QTY 10) REF 22375

Abutment Adapter

Titanium and Stainless steel

For removal of 20° and 45° UniAbutment **without** grooves. Used together with Ratchet Wrench/Torque Wrench/Surgical Wrench or Wrench 22124.

Short, 25 mm
REF 24424



Long, 35 mm
REF 24370



O-ring, Abutment Adapter, Plastic (QTY 10) REF 22376

Removal Tool M1.4

Stainless steel

For removal of UniAbutment 20° and 45° **with** grooves and Cresco Insert 20° and 45°. Used together with Ratchet Wrench/Torque Wrench/Surgical Wrench and Wrench 22124.

Short, 18 mm
REF 24021



Long, 30 mm
REF 24037



UniAbutment Retriever

Stainless steel

For retrieval of UniAbutments. Can also be used for Cresco inserts. Used together with Wrench 22124.

14 mm
REF 22429



Thread Taps

To create new threads internally in a damaged implant/abutment. For manual use only. Used together with Driver Handle.

1.4 mm
REF 22871



1.6 mm
REF 22873



2.0 mm
REF 22875



DA 4 Metal Carrier

Stainless steel

Carrier for seating and retrieval of Direct Abutment Ø 4, see also page 22.

17 mm
REF 22850



Ball Wrench

Stainless steel

Wrench for seating and removal of Ball Abutment. Used together with Ratchet Wrench/Torque Wrench/Surgical Wrench.

20 mm
REF 24367



Patient information material

It is important to inform your patients about the option of dental implant treatment and the many benefits that it can provide. To support you, we offer a selection of patient information material. For further information please ask your local representative or visit www.dentsplyimplants.com.

Order by reference number

REF	page	REF	page		
22054	Direct Abutment™ 4 Replica	20	22447	Temporary Cylinder Angled	25
22060	Temporary Cylinder Uni 20°	25	22448	Burnout Cylinder Angled	25
22061	Temporary Cylinder Uni 45°	25	22462	Twist Drill Ø 4.2, 8–19 mm (yellow) Long	40
22064	Direct Abutment™ 5 Replica	20	22463	Twist Drill Ø 4.2, 8–13 mm (yellow) Short	40
22065	Direct Abutment™ 6 Replica	20	22464	Twist Drill Ø 4.7, 8–19 mm (blue) Long	40
22068	20°/45° UniAbutment Transfer	24	22465	Twist Drill Ø 4.7, 8–13 mm (blue) Short	40
22069	Abutment Replica Uni 20°	24	22466	Twist Drill Ø 4.85, 8–19 mm (pink) Long	40
22070	Abutment Replica Uni 45°	24	22467	Twist Drill Ø 4.85, 8–13 mm (pink) Short	40
22122	Fragment Fork, Thin, 1.0 mm	50	22468	Pilot Drill Ø 3.7/4.2 (yellow) Short	40
22124	Wrench	35	22469	Cortical Drill Ø 4.7/5.0 (blue) Short	40
22131	Mucosal Punch Ø 4.0	43	22471	Polishing Protector Uni 20°	48
22137	Titanium Bowl	35	22474	Polishing Protector Uni 45°	48
22167	Bridge Screw Slot	25	22487	Abutment Screw Angled 4.5/5.0 – M2	23
22170	Grinding Device Uni 20°	48	22495	Restorative Tray	45
22176	Irrigation Set	42	22505	Ball Abutment Replica	30
22177	Irrigation Tube	43	22506	Slot Screwdriver – Short	47
22179	BoneTrap™	43	22507	Slot Screwdriver – Intermediate	47
22182	OD Cylinder Uni 20°	31	22508	Slot Screwdriver – Long	47
22183	OD Cylinder Uni 45°	31	22514	Hex Screwdriver – Short	46
22184	Semi-Burnout Cylinder Uni 20°	25	22515	Hex Screwdriver – Intermediate	46
22185	Semi-Burnout Cylinder Uni 45°	25	22516	Hex Screwdriver – Long	46
22186	Burnout Cylinder Uni 20°	25	22520	Drill Extension	41
22187	Burnout Cylinder Uni 45°	25	22548	Hex CA Driver – Short	35, 46
22190	Abutment Guide Pin – 13 mm	24	22549	Hex CA Driver – Long	35, 46
22192	Implant Retriever	50	22552	Mucosal Punch Ø 5.0	43
22197	Abutment Guide Pin – 16 mm	24	22632	Fragment Fork, Wide, 1.4 mm	50
22198	Abutment Guide Pin – 19 mm	24	22688	Slot CA Driver – Short	47
22199	Abutment Guide Pin – 22 mm	24	22689	Slot CA Driver – Long	47
22362	Round Bar	31	22710	Direct Abutment™ 4 Impression Pick-up	20
22363	Rider, Round Bar	31	22711	Direct Abutment™ 5 Impression Pick-up	20
22364	Ball Housing	30	22712	Direct Abutment™ 6 Impression Pick-up	20
22365	Deactivator, Ball Housing	30	22720	Direct Abutment™ 4 Healing Cap	20
22366	Activator, Ball Housing	30	22721	Direct Abutment™ 5 Healing Cap	20
22371	Paralleling Mandrel, Female	30	22722	Direct Abutment™ 6 Healing Cap	20
22372	Direct Abutment™ 4 Burnout Cylinder	20	22740	Grinding Handle	48
22373	Direct Abutment™ 5 Burnout Cylinder	20	22798	Titanium Cylinder Uni 20°	25
22375	O-ring, Implant Adapter, Plastic	50	22799	Titanium Cylinder Uni 45°	25
22376	O-ring, Abutment Adapter, Plastic	50	22800	Guide Drill Ø 1.8	40
22379	Direct Abutment™ 6 Burnout Cylinder	20	22801	Twist Drill Ø 2.5, 8–19 mm (red) Long	40
22381	Profile Bar System	31	22802	Twist Drill Ø 2.5, 8–13 mm (red) Short	40
22382	Profile Bar Insert	31	22803	Pilot Drill Ø 2.5/3.2 (green) Short	41
22383	Clix Female	30	22805	Pilot Drill Ø 3.2/3.7 (black) Short	41
22384	Clix Inserts	30	22807	Twist Drill Ø 3.2, 8–19 mm (green) Long	40
22385	Clix Insertion Tool	30	22808	Twist Drill Ø 3.35, 8–19 mm (lilac) Long	40
22416	O-ring, Carrier Extension	46	22809	Twist Drill Ø 3.7, 8–19 mm (black) Long	40
22429	UniAbutment Retriever	50	22810	Twist Drill Ø 3.85, 8–19 mm (brown) Long	40
22434	Direction Indicator 2.0/3.2	34	22811	Twist Drill Ø 3.2, 8–13 mm (green) Short	40
22435	Bridge Screw Hex	26	22812	Twist Drill Ø 3.35, 8–13 mm (lilac) Short	40
22437	Forceps – 94 mm	35	22813	Twist Drill Ø 3.7, 8–13 mm (black) Short	40
22439	Ball Abutment Pick-up	30	22814	Twist Drill Ø 3.85, 8–13 mm (brown) Short	40

REF		page
22815	Cortical Drill Ø 3.2/3.5 (green) Short	41
22816	Cortical Drill Ø 3.7/4.0 (black) Short	41
22820	Grinding Device Cylinder, Bridge Hole	48
22843	CastDesign™ 3.5/4.0	17
22844	CastDesign™ 4.5/5.0	17
22850	DA 4 Metal Carrier	20, 51
22851	TempDesign™ 3.5/4.0	14
22852	TempDesign™ 4.5/5.0	14
22853	TempDesign™ 3.5/4.0 NI	14
22854	TempDesign™ 4.5/5.0 NI	14
22864	Removal/Retrieval Kit	50
22871	Thread Tap, 1.4 mm	51
22873	Thread Tap, 1.6 mm	51
22875	Thread Tap, 2.0 mm	51
22876	20° UniAbutment Pick-up Ø 5.5	24
22878	45° UniAbutment Pick-up Ø 5.5	24
22882	20° UniAbutment Pick-up Ø 4.3	24
22883	45° UniAbutment Pick-up Ø 4.3	24
22884	Trephine Drill, Ø 3.5	50
22885	Trephine Drill, Ø 4.0	50
22886	Twist Drill Ø 2.0, 8–19 mm (no color) Long	40
22887	Twist Drill Ø 2.0, 8–13 mm (no color) Short	40
22890	Trephine Drill, Ø 5.0	50
22894	Conical Drill Ø 4.5 (green) Short	41
22895	Conical Drill Ø 4.5 (green) Long	41
22896	Conical Drill Ø 5.0 (black) Short	41
22897	Conical Drill Ø 5.0 (black) Long	41
22898	SP Drill Kit, Short	38
22899	SP Drill Kit, Long	38
22903	Contra Angle	41
22904	SP Pilot Drill Ø 2.0/3.2 Short	38
22905	SP Pilot Drill Ø 2.0/3.2 Long	38
22906	SP Pilot Drill Ø 3.2/3.7 Short	38
22907	SP Pilot Drill Ø 3.2/3.7 Long	38
22908	SP Twist Drill Ø 3.35, 8–13 mm Short	38
22909	SP Twist Drill Ø 3.35, 8–19 mm Long	38
22910	SP Twist Drill Ø 3.7, 8–13 mm Short	38
22911	SP Twist Drill Ø 3.7, 8–19 mm Long	38
22912	SP Twist Drill Ø 3.85, 8–13 mm Short	38
22913	SP Twist Drill Ø 3.85, 8–19 mm Long	38
22914	SP Cortical Drill Ø 3.2/3.5 Short	38
22915	SP Cortical Drill Ø 3.5 Long	38
22916	SP Cortical Drill Ø 3.7/4.0 Short	38
22917	SP Cortical Drill Ø 4.0 Long	38
22921	SP Conical Drill Ø 3.2/4.5 Short	38
22922	SP Conical Drill Ø 4.5 Long	38
22923	SP Conical Drill Ø 3.7/5.0 Short	38
22924	SP Conical Drill Ø 5.0 Long	38
22930	Osteotome 2.0/2.5, Round, Straight	36
22931	Osteotome 2.5/3.2, Round, Straight	36
22932	Osteotome 3.2, Round, Straight	36
22933	Osteotome 3.2/3.7, Round, Straight	36
22934	Osteotome 3.7, Round, Straight	36
22935	Osteotome 3.2/4.3, Round, Conical, Straight	36
22936	Osteotome 3.7/4.8, Round, Conical, Straight	36
22937	Osteotome Set, Round	36
22940	Osteotome 2.0/2.5, Concave, Bayonet	36
22941	Osteotome 2.5/3.2, Concave, Bayonet	36
22942	Osteotome 3.2, Concave, Bayonet	36
22943	Osteotome 3.2/3.7, Concave, Bayonet	36
22944	Osteotome 3.7, Concave, Bayonet	36
22945	Osteotome 3.2/4.3, Concave, Conical, Bayonet	36
22946	Osteotome 3.7/4.8, Concave, Conical, Bayonet	36
22947	Osteotome Set, Concave	36
22953	Osteotome Tray, Large	37
22955	Osteotome Mallet, Small	36
22956	Osteotome Kit	36
22957	SP Twist Drill Ø 4.2, 8–13 mm Short	38
22958	SP Twist Drill Ø 4.2, 8–19 mm Long	38
22959	SP Twist Drill Ø 4.7, 8–13 mm Short	38
22960	SP Twist Drill Ø 4.7, 8–19 mm Long	38
22961	SP Twist Drill Ø 4.85, 8–13 mm Short	38
22962	SP Twist Drill Ø 4.85, 8–19 mm Long	38
22963	SP Pilot Drill Ø 3.7/4.2 Short	38
22964	SP Cortical Drill Ø 4.7/5.0 Short	38
24021	Removal Tool M1.4 – Short	51

REF		page
24037	Removal Tool M1.4 – Long	51
24075	Torque Wrench	46
24092	Healing Cap, Angled Ø 5 – 7.5 mm	23
24093	Torque Wrench Bit Hex, Short	45
24094	Torque Wrench Bit Hex, Long	45
24095	Torque Wrench Bit Slot, Short	45
24096	Torque Wrench Bit Slot, Long	45
24097	Torque Wrench Connector, Adapter	43
24098	Torque Wrench Instrument Lubricant	45
24099	Torque Wrench Dismantle Tool	45
24100	Torque Wrench Kit	45
24133	Handpiece Connector Carrier	47
24134	Carrier Extension – Short	47
24135	Carrier Extension – Long	47
24137	Direct Abutment™ 4 Carrier	20
24138	Direct Abutment™ 5 Carrier	20
24139	Direct Abutment™ 6 Carrier	20
24158	20° ProHeal Cap Short Ø 5.5 – 3.8 mm	23
24159	20° ProHeal Cap Long Ø 5.5 – 5.8 mm	23
24160	45° ProHeal Cap Short Ø 5.5 – 3.8 mm	23
24161	45° ProHeal Cap Long Ø 5.5 – 5.8 mm	23
24162	20° ProHeal Cap Short Ø 4.3 – 4 mm	23
24163	45° ProHeal Cap Short Ø 4.3 – 2.7 mm	23
24189	Abutment Screw 3.0 – M1.4	16
24193	Implant Adapter M1.6 – Short	50
24194	Implant Adapter M1.6 – Long	50
24198	Cover Screw 3.0 – 0 mm	12
24199	SP Twist Drill Ø 3.7, 6–13 mm	41
24207	Pilot Drill Ø 2.0/3.2 mm, Green	41
24209	Abutment Screw Design 4.5/5.0 – M2	14
24227	Abutment Replica Angled	24
24235	TiDesign™ 4.5/5.0 – Ø 5.5, 1.5 mm	17
24236	TiDesign™ 4.5/5.0 – Ø 5.5, 3 mm	17
24237	TiDesign™ 4.5/5.0 – Ø 6.5, 1.5 mm	17
24238	TiDesign™ 4.5/5.0 – Ø 6.5, 3 mm	17
24239	TiDesign™ 4.5/5.0 – Ø 5.5, 20°	17
24243	Semi-Burnout Cylinder Angled	25
24244	Titanium Cylinder Angled	25
24245	Angled Abutment 3.5/4.0 – 0.8 mm	23
24246	Angled Abutment 3.5/4.0 – 2 mm	23
24247	Angled Abutment 4.5/5.0 – 0.8 mm	23
24248	Angled Abutment 4.5/5.0 – 2 mm	23
24254	Angled Abutment Pick-up	24
24264	Drill Set, TiN-coated	40
24268	Locator™ Abutment 3.5/4.0 – Ø 3.7, 1 mm	28
24269	Locator™ Abutment 3.5/4.0 – Ø 3.7, 2 mm	28
24270	Locator™ Abutment 3.5/4.0 – Ø 3.7, 3 mm	28
24271	Locator™ Abutment 3.5/4.0 – Ø 3.7, 4 mm	28
24272	Locator™ Abutment 3.5/4.0 – Ø 3.7, 5 mm	28
24274	Periotome Posterior, curved/straight edge	34
24275	Periotome Anterior, curved/straight edge	34
24280	Temporary Abutment 3.5/4.0 NI	14
24281	Temporary Abutment 3.5/4.0	14
24285	TiDesign™ 3.5/4.0 – Ø 4.5, 1.5 mm	17
24286	TiDesign™ 3.5/4.0 – Ø 4.5, 3 mm	17
24287	TiDesign™ 3.5/4.0 – Ø 5.5, 1.5 mm	17
24288	TiDesign™ 3.5/4.0 – Ø 5.5, 3 mm	17
24289	TiDesign™ 3.5/4.0 – Ø 6.5, 1.5 mm	17
24290	TiDesign™ 3.5/4.0 – Ø 6.5, 3 mm	17
24291	TiDesign™ 3.5/4.0 – Ø 4.5, 20°	17
24292	TiDesign™ 3.5/4.0 – Ø 5.5, 20°	19
24328	Cover Screw 3.5/4.0 – 0 mm	12
24329	Cover Screw 3.5/4.0 – 1 mm	12
24339	Osteotome 3.7/4.2, Round, Straight	37
24347	Angled Abutment 3.5/4.0 NI – 0.8 mm	23
24348	Angled Abutment 3.5/4.0 NI – 2 mm	23
24349	Surgical Tray	33
24350	Contra Angle	42
24357	Ratchet Wrench	34
24358	Driver Handle	34, 49
24360	Implant Unit SI 915, 115 V	42
24367	Ball Wrench	30, 51
24368	Implant Adapter M2 – Long	50
24369	Implant Adapter M2 – Short	50
24370	Abutment Adapter – Long	50
24374	Healing Abutment Uni 3.5./4.0 – 2 mm	12

REF		page
24375	Healing Abutment Uni 3.5./4.0 – 4 mm	12
24376	Healing Abutment Uni 3.5./4.0 – 6 mm	12
24377	Healing Abutment Uni 3.5./4.0 – 8 mm	12
24378	Healing Abutment Uni 3.5./4.0 – 10 mm	12
24379	Healing Abutment Uni 4.5./5.0 – 2 mm	12
24380	Healing Abutment Uni 4.5./5.0 – 4 mm	12
24381	Healing Abutment Uni 4.5./5.0 – 6 mm	12
24382	Healing Abutment Uni 4.5./5.0 – 8 mm	12
24383	Healing Abutment Uni 4.5./5.0 – 10 mm	12
24398	20° UniAbutment 4.5/5.0 – 0.5 mm	22
24399	20° UniAbutment 4.5/5.0 – 1 mm	22
24400	20° UniAbutment 4.5/5.0 – 2 mm	22
24401	20° UniAbutment 4.5/5.0 – 4 mm	22
24402	20° UniAbutment 4.5/5.0 – 6 mm	22
24403	20° UniAbutment 4.5/5.0 – 8 mm	22
24406	45° UniAbutment 4.5/5.0 – 0.5 mm	22
24407	45° UniAbutment 4.5/5.0 – 1 mm	22
24408	45° UniAbutment 4.5/5.0 – 2 mm	22
24409	45° UniAbutment 4.5/5.0 – 4 mm	22
24410	45° UniAbutment 4.5/5.0 – 6 mm	22
24411	45° UniAbutment 4.5/5.0 – 8 mm	22
24412	Implant Unit SI 923, 230 V	42
24418	Ball Abutment 4.5/5.0 – 0.5 mm	29
24419	Ball Abutment 4.5/5.0 – 1 mm	29
24420	Ball Abutment 4.5/5.0 – 2 mm	29
24421	Ball Abutment 4.5/5.0 – 4 mm	29
24422	Ball Abutment 4.5/5.0 – 6 mm	29
24423	Ball Abutment 4.5/5.0 – 8 mm	29
24424	Abutment Adapter – Short	50
24439	Abutment Screw Angled 3.5/4.0 – M1.6	24
24447	Cover Screw 4.5/5.0 – 0 mm	12
24448	Cover Screw 4.5/5.0 – 1 mm	12
24449	Abutment Screw Design 3.5/4.0 – M1.6	14
24477	Locator™ Abutment 4.5/5.0 – Ø 3.7, 0.5 mm	28
24478	Locator™ Abutment 4.5/5.0 – Ø 3.7, 2 mm	28
24479	Locator™ Abutment 4.5/5.0 – Ø 3.7, 3 mm	28
24480	Locator™ Abutment 4.5/5.0 – Ø 3.7, 4 mm	28
24481	Locator™ Abutment 4.5/5.0 – Ø 3.7, 5 mm	28
24482	Locator™ Core Tool	29
24483	Locator™ Process Kit	28
24484	Locator™ Abutment Pick-up	28
24485	Locator™ Abutment Replica	28
24486	Locator™ Insert Clear	28
24487	Locator™ Insert Pink	28
24488	Locator™ Insert Blue	28
24489	Locator™ Insert Green	28
24490	Locator™ Torque Wrench Bit – 15 mm	29
24491	Locator™ Torque Wrench Bit – 21 mm	29
24492	Locator™ Insert Red	28
24527	Direct Abutment™ 4.5/5.0 – Ø 5, 0.5 mm	20
24528	Direct Abutment™ 4.5/5.0 – Ø 5, 1 mm	20
24529	Direct Abutment™ 4.5/5.0 – Ø 5, 2.5 mm	20
24530	Direct Abutment™ 4.5/5.0 – Ø 5, 4 mm	20
24537	Direct Abutment™ 4.5/5.0 – Ø 6, 1 mm	20
24538	Direct Abutment™ 4.5/5.0 – Ø 6, 2.5 mm	20
24539	Direct Abutment™ 4.5/5.0 – Ø 6, 4 mm	20
24558	Direct Abutment API™ 4.5/5.0 – Ø 5, 0.5 mm	19
24559	Direct Abutment API™ 4.5/5.0 – Ø 5, 1 mm	19
24560	Direct Abutment API™ 4.5/5.0 – Ø 5, 2.5 mm	19
24561	Direct Abutment API™ 4.5/5.0 – Ø 5, 4 mm	19
24562	Direct Abutment API™ 4.5/5.0 – Ø 6, 1 mm	19
24563	Direct Abutment API™ 4.5/5.0 – Ø 6, 2.5 mm	19
24564	Direct Abutment API™ 4.5/5.0 – Ø 6, 4 mm	19
24572	Wrench Adapter	34
24573	Abutment Depth Gauge	47
24574	Healing Abutment 3.5/4.0 – Ø 4, 2 mm	13
24575	Healing Abutment 3.5/4.0 – Ø 4.5, 4 mm	13
24576	Healing Abutment 3.5/4.0 – Ø 4.5, 6 mm	13
24577	Healing Abutment 3.5/4.0 – Ø 5.5, 2 mm	13
24578	Healing Abutment 3.5/4.0 – Ø 5.5, 4 mm	13
24579	Healing Abutment 3.5/4.0 – Ø 5.5, 6 mm	13
24580	Healing Abutment 3.5/4.0 – Ø 6.5, 4 mm	13
24581	Healing Abutment 3.5/4.0 – Ø 6.5, 6 mm	13
24582	Healing Abutment 4.5/5.0 – Ø 5.5, 2 mm	13
24583	Healing Abutment 4.5/5.0 – Ø 5.5, 4 mm	13
24584	Healing Abutment 4.5/5.0 – Ø 5.5, 6 mm	13

REF		page
24585	Healing Abutment 4.5/5.0 – Ø 6.5, 2 mm	13
24586	Healing Abutment 4.5/5.0 – Ø 6.5, 4 mm	13
24587	Healing Abutment 4.5/5.0 – Ø 6.5, 6 mm	13
24606	Angled Abutment 4.5/5.0 NI – 0.5 mm	23
24607	Angled Abutment 4.5/5.0 NI – 2 mm	23
24684	Osteotome 4.2, Round, Straight	37
24685	Osteotome 4.2/4.7, Round, Straight	37
24686	Osteotome 4.7, Round, Straight	37
24687	Osteotome Set 5.0 S, Round	37
24688	Osteotome 3.7/4.2, Concave, Bayonet	37
24689	Osteotome 4.2, Concave, Bayonet	37
24690	Osteotome 4.2/4.7, Concave, Bayonet	37
24691	Osteotome 4.7, Concave, Bayonet	37
24692	Osteotome Set 5.0 S, Concave	37
24693	Osteotome Tray, Small	37
24702	ZirDesign™ 3.5/4.0 – Ø 4.4, 1.5 mm	16
24703	ZirDesign™ 3.5/4.0 – Ø 4.5, 3 mm	16
24704	ZirDesign™ 3.5/4.0 – Ø 5.5, 1.5 mm	16
24705	ZirDesign™ 3.5/4.0 – Ø 5.5, 3 mm	16
24706	ZirDesign™ 3.5/4.0 – Ø 5.5, 3.5 mm, 20°	16
24707	ZirDesign™ 4.5/5.0 – Ø 5.5, 1.5 mm	16
24708	ZirDesign™ 4.5/5.0 – Ø 5.5, 3 mm	16
24709	ZirDesign™ 4.5/5.0 – Ø 6.5, 1.5 mm	16
24710	ZirDesign™ 4.5/5.0 – Ø 6.5, 3 mm	16
24711	ZirDesign™ 4.5/5.0 – Ø 5.5, 3.5 mm, 20°	16
24734	SP Twist Drill Ø 3.85, 6–13 mm	38
24735	SP Pilot Drill Ø 2.0/3.2, 6–13 mm	38
24737	SP Drill Kit 6–13 mm	38
24777	Healing Abutment 3.0 – Ø 4, 2 mm	13
24778	Healing Abutment 3.0 – Ø 4, 4 mm	13
24788	TiDesign 3.0 – Ø 4.0, 1 mm	16
24789	TiDesign 3.0 – Ø 4.0, 2 mm	16
24790	TiDesign 3.0 – Ø 4.0, 15° mm	16
24795	Pilot Drill Ø 2.0/2.7 (light blue)	41
24796	Twist Drill Ø 2.7, 8–19 mm (light blue) Long	40
24797	Twist Drill Ø 2.7, 8–13 mm (light blue) Short	39
24798	Twist Drill Ø 2.85, 8–19 mm (silver) Long	39
24799	Twist Drill Ø 2.85, 8–13 mm (silver) Short	39
24800	Cortical Drill Ø 2.7/3.0 (light blue) Short	39
24801	Implant Depth Gauge, 6–19 mm	34
24802	Lab Abutment Screw Design 3.0	48
24803	RA Mucosal Punch 4.5/5.0	43
24839	Try-in Kit Direct Abutment	46
24847	Ti-ZirDesign™ 3.5/4.0 Try-in	46
24848	Direct Abutment 3.5/4.0 Try-in	46
24849	Ti-ZirDesign™ 4.5/5.0 Try-in	46
24850	Direct Abutment 4.5/5.0 Try-in	46
24857	Lab Abutment Screw Design 3.5/4.0	48
24858	Lab Abutment Screw Design 4.5/5.0	48
24859	Lab bridge screw, hex and slot	48
24860	Lab Abutment Screw, Angled	48
24879	Restorative Instrument Kit	45
24892	Radiographic Implant Guides	11
24893	20° UniAbutment 3.5/4.0 – 0.5 mm	22
24894	20° UniAbutment 3.5/4.0 – 1 mm	22
24895	20° UniAbutment 3.5/4.0 – 2 mm	22
24896	20° UniAbutment 3.5/4.0 – 4 mm	22
24897	20° UniAbutment 3.5/4.0 – 6 mm	22
24898	20° UniAbutment 3.5/4.0 – 8 mm	22
24899	45° UniAbutment 3.5/4.0 – 0.5 mm	22
24900	45° UniAbutment 3.5/4.0 – 1 mm	22
24901	45° UniAbutment 3.5/4.0 – 2 mm	22
24902	45° UniAbutment 3.5/4.0 – 4 mm	22
24903	45° UniAbutment 3.5/4.0 – 6 mm	22
24904	45° UniAbutment 3.5/4.0 – 8 mm	22
24905	Ball Abutment 3.5/4.0 – 1 mm	29
24906	Ball Abutment 3.5/4.0 – 2 mm	29
24907	Ball Abutment 3.5/4.0 – 4 mm	29
24908	Ball Abutment 3.5/4.0 – 6 mm	29
24909	Ball Abutment 3.5/4.0 – 8 mm	29
24910	Direct Abutment™ 3.5/4.0 – Ø 4, 0.5 mm	20
24911	Direct Abutment™ 3.5/4.0 – Ø 4, 1 mm	20
24912	Direct Abutment™ 3.5/4.0 – Ø 4, 2.5 mm	20
24913	Direct Abutment™ 3.5/4.0 – Ø 4, 4 mm	20
24914	Direct Abutment™ 3.5/4.0 – Ø 5, 1 mm	20
24915	Direct Abutment™ 3.5/4.0 – Ø 5, 2.5 mm	20

REF		page
24916	Direct Abutment™ 3.5/4.0 – Ø 5, 4 mm	20
24917	Direct Abutment API™ 3.5/4.0 – Ø 4, 0.5 mm	19
24918	Direct Abutment API™ 3.5/4.0 – Ø 4, 1 mm	19
24919	Direct Abutment API™ 3.5/4.0 – Ø 4, 2.5 mm	19
24920	Direct Abutment API™ 3.5/4.0 – Ø 4, 4 mm	19
24921	Direct Abutment API™ 3.5/4.0 – Ø 5, 1 mm	19
24922	Direct Abutment API™ 3.5/4.0 – Ø 5, 2.5 mm	19
24923	Direct Abutment API™ 3.5/4.0 – Ø 5, 4 mm	19
24924	Conical Drill 4.5/5.0 (light blue) Short	41
24925	Conical Drill Ø 2.7/4.5 (light blue) Long	41
24926	Conical Drill Ø 3.2/5.0 (no color) Short	41
24927	Conical Drill Ø 3.2/5.0 (no color) Long	41
24928	Implant Pick-up 4.5/5.0 NI – Short	18
24929	Implant Pick-up 4.5/5.0 NI – Long	18
24930	OsseoSpeed™ TX 3.5 S – 8 mm	10
24931	OsseoSpeed™ TX 3.5 S – 9 mm	10
24932	OsseoSpeed™ TX 3.5 S – 11 mm	10
24933	OsseoSpeed™ TX 3.5 S – 13 mm	10
24934	OsseoSpeed™ TX 3.5 S – 15 mm	10
24935	OsseoSpeed™ TX 3.5 S – 17 mm	10
24936	Implant Pick-up 3.5/4.0 NI – Short	18
24937	Implant Pick-up 3.5/4.0 NI – Long	18
24938	Implant Pick-up 4.5/5.0 – Short	18
24939	OsseoSpeed™ TX 4.0 S – 6 mm	10
24940	OsseoSpeed™ TX 4.0 S – 8 mm	10
24941	OsseoSpeed™ TX 4.0 S – 9 mm	10
24942	OsseoSpeed™ TX 4.0 S – 11 mm	10
24943	OsseoSpeed™ TX 4.0 S – 13 mm	10
24944	OsseoSpeed™ TX 4.0 S – 15 mm	10
24945	OsseoSpeed™ TX 4.0 S – 17 mm	10
24946	Implant Pick-up 4.5/5.0 – Long	18
24947	Implant Pick-up 3.5/4.0 – Short	18
24948	Implant Pick-up 3.5/4.0 – Long	18
24949	Implant Pick-up 3.0 – Long	18
24950	Implant Pick-up 3.0 – Short	18
24951	OsseoSpeed™ TX 4.5 – 9 mm	11
24952	OsseoSpeed™ TX 4.5 – 11 mm	11
24953	OsseoSpeed™ TX 4.5 – 13 mm	11
24954	OsseoSpeed™ TX 4.5 – 15 mm	11
24955	OsseoSpeed™ TX 4.5 – 17 mm	11
24956	Implant Transfer 4.5/5.0 – Short	18
24957	Implant Transfer 4.5/5.0 – Long	18
24958	Implant Transfer 3.0 – Long	18
24959	Implant Transfer 3.5/4.0 – Short	18
24960	Implant Transfer 3.5/4.0 – Long	18
24961	OsseoSpeed™ TX 5.0 – 9 mm	11
24962	OsseoSpeed™ TX 5.0 – 11 mm	11
24963	OsseoSpeed™ TX 5.0 – 13 mm	11
24964	OsseoSpeed™ TX 5.0 – 15 mm	11
24965	OsseoSpeed™ TX 5.0 – 17 mm	11
24966	Implant Guide Pin Design 4.5/5.0 – Short	18
24967	Implant Guide Pin Design 4.5/5.0 – Long	18
24968	Implant Guide Pin Design 3.5/4.0 – Short	18
24969	Implant Guide Pin Design 3.5/4.0 – Long	18
24970	Implant Guide Pin Design 3.0 – Short	18
24971	OsseoSpeed™ TX 5.0 S – 9 mm	11
24972	OsseoSpeed™ TX 5.0 S – 11 mm	11
24973	OsseoSpeed™ TX 5.0 S – 13 mm	11
24974	OsseoSpeed™ TX 5.0 S – 15 mm	11
24975	OsseoSpeed™ TX 5.0 S – 17 mm	11
24976	Implant Guide Pin Design 3.0 – Long	18
24977	Implant Replica 3.0	18
24978	Implant Replica 3.5/4.0	18
24979	Implant Replica 4.5/5.0	18

REF		page
24980	Surgical Instrument Kit	35
24982	OsseoSpeed™ TX 3.0 S – 11 mm	10
24983	OsseoSpeed™ TX 3.0 S – 13 mm	10
24984	OsseoSpeed™ TX 3.0 S – 15 mm	10
24991	SP Twist Drill Ø 2.0 mm Long	39
24992	SP Twist Drill Ø 2.0 mm Short	39
24993	SP Twist Drill Ø 2.7 mm Long	39
24994	SP Twist Drill Ø 2.7 mm Short	39
24995	SP Twist Drill Ø 2.85 mm Long	39
24996	SP Twist Drill Ø 2.85 mm Short	39
24997	SP Pilot Drill Ø 2.0/2.7 mm Short	39
24998	SP Cortical Drill Ø 2.7/3.0 mm Short	39
24999	SP Conical Drill Ø 2.7/4.5 mm Short	39
25000	SP Conical Drill Ø 2.7/4.5 mm Long	39
25001	SP Conical Drill Ø 3.2/5.0 mm Short	39
25002	SP Conical Drill Ø 3.2/5.0 mm Long	39
25007	Implant Driver 3.0 – Short	33
25008	Implant Driver 3.0 – Long	33
25009	Implant Driver 3.5/4.0 – Short	33
25010	Implant Driver 3.5/4.0 – Long	33
25011	Implant Driver 4.5/5.0 – Short	33
25012	Implant Driver 4.5/5.0 – Long	33
25015	Temporary Abutment 4.5/5.0	14
25016	Temporary Abutment 4.5/5.0 NI	14
25017	Healing Abutment 3.0 – Ø 4, 6 mm	13
25018	Temporary Abutment 3.0	14
30305	Cresco API™ Titanium 4.5/5.0 45° – 0.7 mm	26
30310	Cresco API™ Titanium 4.5/5.0 45° – 2 mm	26
30312	Cresco API™ Titanium 4.5/5.0 20° – 0.5 mm	26
30322	Cresco API™ Titanium 4.5/5.0 20° – 2 mm	26
30505	Cresco API™ Burnout 4.5/5.0 45° – 0.7 mm	26
30351	Cresco API™ Titanium 3.5/4.0 20° – 0.5 mm	26
30352	Cresco API™ Titanium 3.5/4.0 20° – 2 mm	26
30353	Cresco API™ Titanium 3.5/4.0 45° – 0.7 mm	26
30354	Cresco API™ Titanium 3.5/4.0 45° – 2 mm	26
30510	Cresco API™ Burnout 4.5/5.0 45° – 2 mm	26
30512	Cresco API™ Burnout 4.5/5.0 20° – 0.5 mm	26
30522	Cresco API™ Burnout 4.5/5.0 20° – 2 mm	26
30551	Cresco API™ Burnout 3.5/4.0 20° – 0.5 mm	26
30552	Cresco API™ Burnout 3.5/4.0 20° – 2 mm	26
30553	Cresco API™ Burnout 3.5/4.0 45° – 0.7 mm	26
30554	Cresco API™ Burnout 3.5/4.0 45° – 2 mm	26
30851	Cresco API™ Cobalt-Chrome 3.5/4.0 20° – 0.5 mm	26
30852	Cresco API™ Cobalt-Chrome 3.5/4.0 20° – 2 mm	26
30853	Cresco API™ Cobalt-Chrome 3.5/4.0 45° – 0.7 mm	26
30854	Cresco API™ Cobalt-Chrome 3.5/4.0 45° – 2 mm	26
30805	Cresco API™ Cobalt-Chrome 4.5/5.0 45° – 0.7 mm	26
30810	Cresco API™ Cobalt-Chrome 4.5/5.0 45° – 2 mm	26
30812	Cresco API™ Cobalt-Chrome 4.5/5.0 20° – 0.5 mm	26
30822	Cresco API™ Cobalt-Chrome 4.5/5.0 20° – 2 mm	26
31252	Cresco™ Slot Screwdriver – 26 mm	49
31253	Cresco™ Slot Screwdriver – 34 mm	49
31254	Cresco™ Slot Screwdriver – Long	49
31264	Cresco™ RA Slot Screwdriver – 34 mm	49
31267	RA Mucosal Punch 3.5/4.0	43
31272	Cresco™ RA Slot Screwdriver – 26 mm	49
31273	Cresco™ RA Slot Screwdriver – 20 mm	49
31274	Cresco™ Slot Screwdriver – 15 mm	49
31276	Cresco™ Torque Ratchet Wrench	49
31690	Cresco™ Waxing Tool	49
68108	Suction Tube	43
68118	Suction Tube	43
68130	Suction Tube	43

Alphabetical order

	REF	page
20° ProHeal Cap Long Ø 5.5 – 5.8 mm	24159	24
20° ProHeal Cap Short Ø 4.3 – 4 mm	24162	24
20° ProHeal Cap Short Ø 5.5 – 3.8 mm	24158	24
20° UniAbutment 3.5/4.0 – 0.5 mm	24893	22
20° UniAbutment 3.5/4.0 – 1 mm	24894	22
20° UniAbutment 3.5/4.0 – 2 mm	24895	22
20° UniAbutment 3.5/4.0 – 4 mm	24896	22
20° UniAbutment 3.5/4.0 – 6 mm	24897	22
20° UniAbutment 3.5/4.0 – 8 mm	24898	22
20° UniAbutment 4.5/5.0 – 0.5 mm	24398	22
20° UniAbutment 4.5/5.0 – 1 mm	24399	22
20° UniAbutment 4.5/5.0 – 2 mm	24400	22
20° UniAbutment 4.5/5.0 – 4 mm	24401	22
20° UniAbutment 4.5/5.0 – 6 mm	24402	22
20° UniAbutment 4.5/5.0 – 8 mm	24403	22
20° UniAbutment Pick-up Ø 4.3	22882	24
20° UniAbutment Pick-up Ø 5.5	22876	24
20°/45° UniAbutment Transfer	22068	24
45° ProHeal Cap Long Ø 5.5 – 5.8 mm	24161	23
45° ProHeal Cap Short Ø 4.3 – 2.7 mm	24163	23
45° ProHeal Cap Short Ø 5.5 – 3.8 mm	24160	23
45° UniAbutment 3.5/4.0 – 0.5 mm	24899	22
45° UniAbutment 3.5/4.0 – 1 mm	24900	22
45° UniAbutment 3.5/4.0 – 2 mm	24901	22
45° UniAbutment 3.5/4.0 – 4 mm	24902	22
45° UniAbutment 3.5/4.0 – 6 mm	24903	22
45° UniAbutment 3.5/4.0 – 8 mm	24904	22
45° UniAbutment 4.5/5.0 – 0.5 mm	24406	22
45° UniAbutment 4.5/5.0 – 1 mm	24407	22
45° UniAbutment 4.5/5.0 – 2 mm	24408	22
45° UniAbutment 4.5/5.0 – 4 mm	24409	22
45° UniAbutment 4.5/5.0 – 6 mm	24410	22
45° UniAbutment 4.5/5.0 – 8 mm	24411	22
45° UniAbutment Pick-up Ø 4.3	22883	24
45° UniAbutment Pick-up Ø 5.5	22878	24
Abutment Adapter – Long	24370	50
Abutment Adapter – Short	24424	50
Abutment Depth Gauge	24573	47
Abutment Guide Pin – 13 mm	22190	24
Abutment Guide Pin – 16 mm	22197	24
Abutment Guide Pin – 19 mm	22198	24
Abutment Guide Pin – 22 mm	22199	24
Abutment Replica Angled	24227	24
Abutment Replica Uni 20°	22069	24
Abutment Replica Uni 45°	22070	24
Abutment Screw 3.0 – M1.4	24189	14
Abutment Screw Angled 4.5/5.0 – M2	22487	23
Abutment Screw Angled 3.5/4.0 – M1.6	24439	23
Abutment Screw Design 3.5/4.0 – M1.6	24449	14
Abutment Screw Design 4.5/5.0 – M2	24209	14
Activator, Ball Housing	22366	30
Angled Abutment 3.5/4.0 – 0.8 mm	24245	23
Angled Abutment 3.5/4.0 – 2 mm	24246	23
Angled Abutment 3.5/4.0 NI – 0.8 mm	24347	23
Angled Abutment 3.5/4.0 NI – 2 mm	24348	23
Angled Abutment 4.5/5.0 – 0.5 mm	24247	23
Angled Abutment 4.5/5.0 – 2 mm	24248	23
Angled Abutment 4.5/5.0 NI – 0.5 mm	24606	23
Angled Abutment 4.5/5.0 NI – 2 mm	24607	23
Angled Abutment Pick-up	24254	24
Ball Abutment 3.5/4.0 – 1 mm	24905	29
Ball Abutment 3.5/4.0 – 2 mm	24906	29
Ball Abutment 3.5/4.0 – 4 mm	24907	29
Ball Abutment 3.5/4.0 – 6 mm	24908	29
Ball Abutment 3.5/4.0 – 8 mm	24909	29
Ball Abutment 4.5/5.0 – 0.5 mm	24418	29
Ball Abutment 4.5/5.0 – 1 mm	24419	29
Ball Abutment 4.5/5.0 – 2 mm	24420	29
Ball Abutment 4.5/5.0 – 4 mm	24421	29
Ball Abutment 4.5/5.0 – 6 mm	24422	29
Ball Abutment 4.5/5.0 – 8 mm	24423	29
Ball Abutment Pick-up	22439	30
Ball Abutment Replica	22505	30
Ball Housing	22364	30

	REF	page
Ball Wrench	24367	30, 51
BoneTrap™	22179	43
Bridge Screw Hex	22435	25
Bridge Screw Slot	22167	25
Burnout Cylinder Angled	22448	25
Burnout Cylinder Uni 20°	22186	25
Burnout Cylinder Uni 45°	22187	25
Carrier Extension – Long	24135	47
Carrier Extension – Short	24134	47
CastDesign™ 3.5/4.0	22843	17
CastDesign™ 4.5/5.0	22844	17
Clix Female	22383	30
Clix Inserts	22384	30
Clix Insertion Tool	24385	30
Conical Drill Ø 2.7/4.5 (light blue) Short	24924	41
Conical Drill Ø 2.7/4.5 (light blue) Long	24925	41
Conical Drill Ø 3.2/5.0 (no color) Short	24926	41
Conical Drill Ø 3.2/5.0 (no color) Long	24927	41
Conical Drill Ø 4.5 (green) Long	22895	41
Conical Drill Ø 4.5 (green) Short	22894	41
Conical Drill Ø 5.0 (black) Long	22897	41
Conical Drill Ø 5.0 (black) Short	22896	41
Contra Angle	22903	42
Contra Angle	24350	42
Cortical Drill Ø 2.7/3.0 (light blue) Short	24800	41
Cortical Drill Ø 3.2/3.5 (green) Short	22815	41
Cortical Drill Ø 3.7/4.0 (black) Short	22816	41
Cortical Drill Ø 4.7/5.0 (blue) Short	22469	41
Cover Screw 3.0 – 0 mm	24198	12
Cover Screw 3.5/4.0 – 0 mm	24328	12
Cover Screw 3.5/4.0 – 1 mm	24329	12
Cover Screw 4.5/5.0 – 0 mm	24447	12
Cover Screw 4.5/5.0 – 1 mm	24448	12
Cresco API™ Titanium 3.5/4.0 20° – 0.5 mm	30351	26
Cresco API™ Titanium 3.5/4.0 20° – 2 mm	30352	26
Cresco API™ Titanium 3.5/4.0 45° – 0.7 mm	30353	26
Cresco API™ Titanium 3.5/4.0 45° – 2 mm	30354	26
Cresco API™ Titanium 4.5/5.0 20° – 0.5 mm	30312	26
Cresco API™ Titanium 4.5/5.0 20° – 2 mm	30322	26
Cresco API™ Titanium 4.5/5.0 45° – 0.7 mm	30305	26
Cresco API™ Titanium 4.5/5.0 45° – 2 mm	30310	26
Cresco API™ Burnout 3.5/4.0 20° – 0.5 mm	30551	26
Cresco API™ Burnout 3.5/4.0 20° – 2 mm	30552	26
Cresco API™ Burnout 3.5/4.0 45° – 0.7 mm	30553	26
Cresco API™ Burnout 3.5/4.0 45° – 2 mm	30554	26
Cresco API™ Burnout 4.5/5.0 20° – 0.5 mm	30512	26
Cresco API™ Burnout 4.5/5.0 20° – 2 mm	30522	26
Cresco API™ Burnout 4.5/5.0 45° – 0.7 mm	30505	26
Cresco API™ Burnout 4.5/5.0 45° – 2 mm	30510	26
Cresco API™ Cobalt-Chr 3.5/4.0 20° – 0.5 mm	30851	26
Cresco API™ Cobalt-Chr 3.5/4.0 20° – 2 mm	30852	26
Cresco API™ Cobalt-Chr 3.5/4.0 45° – 0.7 mm	30853	26
Cresco API™ Cobalt-Chr 3.5/4.0 45° – 2 mm	30854	26
Cresco API™ Cobalt-Chr 4.5/5.0 20° – 0.5 mm	30812	26
Cresco API™ Cobalt-Chr 4.5/5.0 20° – 2 mm	30822	26
Cresco API™ Cobalt-Chr 4.5/5.0 45° – 0.7 mm	30805	26
Cresco API™ Cobalt-Chr 4.5/5.0 45° – 2 mm	30810	26
Cresco™ RA Slot Screwdriver – 34 mm	31264	49
Cresco™ RA Slot Screwdriver – 26 mm	31272	49
Cresco™ RA Slot Screwdriver – 20 mm	31273	49
Cresco™ Slot Screwdriver – 26 mm	31252	49
Cresco™ Slot Screwdriver – 34 mm	31253	49
Cresco™ Slot Screwdriver – Long	31254	49
Cresco™ Slot Screwdriver – 15 mm	31274	49
Cresco™ Torque Ratchet Wrench	31276	49
Cresco™ Waxing Tool	31690	49
DA 4 Metal Carrier	22850	20, 51
Deactivator, Ball Housing	22365	30
Direct Abutment 3.5/4.0 – Ø 4, 0.5 mm	24910	20
Direct Abutment™ 3.5/4.0 – Ø 4, 1 mm	24911	20
Direct Abutment™ 3.5/4.0 – Ø 4, 2.5 mm	24912	20
Direct Abutment™ 3.5/4.0 – Ø 4, 4 mm	24913	20
Direct Abutment™ 3.5/4.0 – Ø 5, 1 mm	24914	20
Direct Abutment™ 3.5/4.0 – Ø 5, 2.5 mm	24915	20

	REF	page
Direct Abutment™ 3.5/4.0 – Ø 5, 4 mm	24916	20
Direct Abutment™ 3.5/4.0 Try-in	24848	46
Direct Abutment™ 4.5/5.0 – Ø 5, 0.5 mm	24527	20
Direct Abutment™ 4.5/5.0 – Ø 5, 1 mm	24528	20
Direct Abutment™ 4.5/5.0 – Ø 5, 2.5 mm	24529	20
Direct Abutment™ 4.5/5.0 – Ø 5, 4 mm	24530	20
Direct Abutment™ 4.5/5.0 – Ø 6, 1 mm	24537	20
Direct Abutment™ 4.5/5.0 – Ø 6, 2.5 mm	24538	20
Direct Abutment™ 4.5/5.0 – Ø 6, 4 mm	24539	20
Direct Abutment™ 4.5/5.0 Try-in	24850	46
Direct Abutment™ 4 Healing Cap	22720	20
Direct Abutment™ 5 Healing Cap	22721	20
Direct Abutment™ 6 Healing Cap	22722	20
Direct Abutment™ 4 Burnout Cylinder	22372	20
Direct Abutment™ 5 Burnout Cylinder	22373	20
Direct Abutment™ 6 Burnout Cylinder	22379	20
Direct Abutment™ 4 Impression Pick-up	22710	20
Direct Abutment™ 5 Impression Pick-up	22711	20
Direct Abutment™ 6 Impression Pick-up	22712	20
Direct Abutment™ 4 Replica	22054	20
Direct Abutment™ 5 Replica	22064	20
Direct Abutment™ 6 Replica	22065	20
Direct Abutment™ 4 Carrier	24137	20
Direct Abutment™ 5 Carrier	24138	20
Direct Abutment™ 6 Carrier	24139	20
Direct Abutment API™ 3.5/4.0 – Ø 4, 0.5 mm	24917	19
Direct Abutment API™ 3.5/4.0 – Ø 4, 1 mm	24918	19
Direct Abutment API™ 3.5/4.0 – Ø 4, 2.5 mm	24919	19
Direct Abutment API™ 3.5/4.0 – Ø 4, 4 mm	24920	19
Direct Abutment API™ 3.5/4.0 – Ø 5, 1 mm	24921	19
Direct Abutment API™ 3.5/4.0 – Ø 5, 2.5 mm	24922	19
Direct Abutment API™ 3.5/4.0 – Ø 5, 4 mm	24923	19
Direct Abutment API™ 4.5/5.0 – Ø 5, 0.5 mm	24558	19
Direct Abutment API™ 4.5/5.0 – Ø 5, 1 mm	24559	19
Direct Abutment API™ 4.5/5.0 – Ø 5, 2.5 mm	24560	19
Direct Abutment API™ 4.5/5.0 – Ø 5, 4 mm	24561	19
Direct Abutment API™ 4.5/5.0 – Ø 6, 1 mm	24562	19
Direct Abutment API™ 4.5/5.0 – Ø 6, 2.5 mm	24563	19
Direct Abutment API™ 4.5/5.0 – Ø 6, 4 mm	24564	19
Direction Indicator 2.0/3.2	22434	34
Drill Extension	22520	41
Drill Set, TiN-coated	24264	40
Driver Handle	24358	34, 49
Forceps – 94 mm	22437	35
Fragment Fork, Thin, 1.0 mm	22122	50
Fragment Fork, Wide, 1.4 mm	22632	50
Grinding Device Cylinder, Bridge Hole	22820	48
Grinding Device Uni 20°	22170	48
Grinding Handle	22740	48
Guide Drill Ø 1.8	22800	40
Handpiece Connector Carrier	24133	47
Healing Abutment 3.0 – Ø 4, 2 mm	24777	13
Healing Abutment 3.0 – Ø 4, 4 mm	24778	13
Healing Abutment 3.0 – Ø 4, 6 mm	25017	13
Healing Abutment 3.5/4.0 – Ø 4, 2 mm	24574	13
Healing Abutment 3.5/4.0 – Ø 4.5, 4 mm	24575	13
Healing Abutment 3.5/4.0 – Ø 4.5, 6 mm	24576	13
Healing Abutment 3.5/4.0 – Ø 5.5, 2 mm	24577	13
Healing Abutment 3.5/4.0 – Ø 5.5, 4 mm	24578	13
Healing Abutment 3.5/4.0 – Ø 5.5, 6 mm	24579	13
Healing Abutment 3.5/4.0 – Ø 6.5, 4 mm	24580	13
Healing Abutment 3.5/4.0 – Ø 6.5, 6 mm	24581	13
Healing Abutment 4.5/5.0 – Ø 5.5, 2 mm	24582	13
Healing Abutment 4.5/5.0 – Ø 5.5, 4 mm	24583	13
Healing Abutment 4.5/5.0 – Ø 5.5, 6 mm	24584	13
Healing Abutment 4.5/5.0 – Ø 6.5, 2 mm	24585	13
Healing Abutment 4.5/5.0 – Ø 6.5, 4 mm	24586	13
Healing Abutment 4.5/5.0 – Ø 6.5, 6 mm	24587	13
Healing Abutment Uni 3.5./4.0 – 10 mm	24378	12
Healing Abutment Uni 3.5./4.0 – 2 mm	24374	12
Healing Abutment Uni 3.5./4.0 – 4 mm	24375	12
Healing Abutment Uni 3.5./4.0 – 6 mm	24376	12
Healing Abutment Uni 3.5./4.0 – 8 mm	24377	12
Healing Abutment Uni 4.5./5.0 – 10 mm	24383	12
Healing Abutment Uni 4.5./5.0 – 2 mm	24379	12
Healing Abutment Uni 4.5./5.0 – 4 mm	24380	12

	REF	page
Healing Abutment Uni 4.5./5.0 – 6 mm	24381	12
Healing Abutment Uni 4.5./5.0 – 8 mm	24382	12
Healing Cap, Angled Ø 5 – 7.5 mm	24092	24
Hex CA Driver – Long	22549	35, 46
Hex CA Driver – Short	22548	35, 46
Hex Screwdriver – Intermediate	22515	35
Hex Screwdriver – Long	22516	35
Hex Screwdriver – Short	22514	35
Implant Adapter M1.6 – Long	24194	50
Implant Adapter M1.6 – Short	24193	50
Implant Adapter M2 – Long	24368	50
Implant Adapter M2 – Short	24369	50
Implant Depth Gauge, 6–19 mm	24801	34
Implant Driver 3.0 – Long	25008	33
Implant Driver 3.0 – Short	25007	33
Implant Driver 3.5/4.0 – Long	25010	33
Implant Driver 3.5/4.0 – Short	25009	33
Implant Driver 4.5/5.0 – Long	25012	33
Implant Driver 4.5/5.0 – Short	25011	33
Implant Guide Pin 3.0 – Long	24976	18
Implant Guide Pin 3.0 – Short	24970	18
Implant Guide Pin 3.5/4.0 – Long	24969	18
Implant Guide Pin 3.5/4.0 – Short	24968	18
Implant Guide Pin 4.5/5.0 – Long	24967	18
Implant Guide Pin 4.5/5.0 – Short	24966	18
Implant Pick-up 3.0 – Long	24949	18
Implant Pick-up 3.0 – Short	24950	18
Implant Pick-up 3.5/4.0 – Long	24948	18
Implant Pick-up 3.5/4.0 – Short	24947	18
Implant Pick-up 3.5/4.0 NI – Long	24937	18
Implant Pick-up 3.5/4.0 NI – Short	24936	18
Implant Pick-up 4.5/5.0 – Long	24946	18
Implant Pick-up 4.5/5.0 NI – Long	24929	18
Implant Pick-up 4.5/5.0 – Short	24938	18
Implant Pick-up 4.5/5.0 NI – Short	24928	18
Implant Replica 3.0	24977	18
Implant Replica 3.5/4.0	24978	18
Implant Replica 4.5/5.0	24979	8
Implant Retriever	22192	50
Implant Transfer 3.0 – Long	24958	18
Implant Transfer 3.5/4.0 – Long	24960	18
Implant Transfer 3.5/4.0 – Short	24959	18
Implant Transfer 4.5/5.0 – Long	24957	18
Implant Transfer 4.5/5.0 – Short	24956	18
Implant Unit SI 915, 115 V	24360	42
Implant Unit SI 923, 230 V	24412	42
Irrigation Set	22176	42
Irrigation Tube	22177	43
Lab Abutment Screw, Angled	24860	48
Lab Abutment Screw 3.0	24802	48
Lab Abutment Screw Design 3.5/4.0	24857	48
Lab Abutment Screw Design 4.5/5.0	24858	48
Lab bridge screw, hex and slot	24859	48
Locator™ Abutment 3.5/4.0 – Ø 3.7, 1 mm	24268	28
Locator™ Abutment 3.5/4.0 – Ø 3.7, 2 mm	24269	28
Locator™ Abutment 3.5/4.0 – Ø 3.7, 3 mm	24270	28
Locator™ Abutment 3.5/4.0 – Ø 3.7, 4 mm	24271	28
Locator™ Abutment 3.5/4.0 – Ø 3.7, 5 mm	24272	28
Locator™ Abutment 4.5/5.0 – Ø 3.7, 0.5 mm	24477	28
Locator™ Abutment 4.5/5.0 – Ø 3.7, 2 mm	24478	28
Locator™ Abutment 4.5/5.0 – Ø 3.7, 3 mm	24479	28
Locator™ Abutment 4.5/5.0 – Ø 3.7, 4 mm	24480	28
Locator™ Abutment 4.5/5.0 – Ø 3.7, 5 mm	24481	28
Locator™ Abutment Pick-up	24484	28
Locator™ Abutment Replica	24485	28
Locator™ Core Tool	24482	29
Locator™ Insert Blue	24488	28
Locator™ Insert Clear	24486	28
Locator™ Insert Green	24489	28
Locator™ Insert Pink	24487	28
Locator™ Insert Red	24492	28
Locator™ Process Kit	24483	28
Locator Torque Wrench Bit – 15 mm	24490	29
Locator Torque Wrench Bit – 21 mm	24491	29
Mucosal Punch Ø 4.0	22131	43
Mucosal Punch Ø 5.0	22552	43

	REF	page
OD Cylinder Uni 20°	22182	31
OD Cylinder Uni 45°	22183	31
O-ring, Abutment Adapter, Plastic	22376	50
O-ring, Carrier Extension	22416	47
O-ring, Implant Adapter, Plastic	22375	50
OsseoSpeed™ TX 3.0 S – 11 mm	24982	10
OsseoSpeed™ TX 3.0 S – 13 mm	24983	10
OsseoSpeed™ TX 3.0 S – 15 mm	24984	10
OsseoSpeed™ TX 3.5 S – 8 mm	24930	10
OsseoSpeed™ TX 3.5 S – 9 mm	24931	10
OsseoSpeed™ TX 3.5 S – 11 mm	24932	10
OsseoSpeed™ TX 3.5 S – 13 mm	24933	10
OsseoSpeed™ TX 3.5 S – 15 mm	24934	10
OsseoSpeed™ TX 3.5 S – 17 mm	24935	10
OsseoSpeed™ TX 4.0 S – 6 mm	24939	10
OsseoSpeed™ TX 4.0 S – 8 mm	24940	10
OsseoSpeed™ TX 4.0 S – 9 mm	24941	10
OsseoSpeed™ TX 4.0 S – 11 mm	24942	10
OsseoSpeed™ TX 4.0 S – 13 mm	24943	10
OsseoSpeed™ TX 4.0 S – 15 mm	24944	10
OsseoSpeed™ TX 4.0 S – 17 mm	24945	10
OsseoSpeed™ TX 4.5 – 9 mm	24951	11
OsseoSpeed™ TX 4.5 – 11 mm	24952	11
OsseoSpeed™ TX 4.5 – 13 mm	24953	11
OsseoSpeed™ TX 4.5 – 15 mm	24954	11
OsseoSpeed™ TX 4.5 – 17 mm	24955	11
OsseoSpeed™ TX 5.0 – 9 mm	24961	11
OsseoSpeed™ TX 5.0 – 11 mm	24962	11
OsseoSpeed™ TX 5.0 – 13 mm	24963	11
OsseoSpeed™ TX 5.0 – 15 mm	24964	11
OsseoSpeed™ TX 5.0 – 17 mm	24965	11
OsseoSpeed™ TX 5.0 S – 9 mm	24971	11
OsseoSpeed™ TX 5.0 S – 11 mm	24972	11
OsseoSpeed™ TX 5.0 S – 13 mm	24973	11
OsseoSpeed™ TX 5.0 S – 15 mm	24974	11
OsseoSpeed™ TX 5.0 S – 17 mm	24975	11
Osteotome 2.0/2.5, Concave, Bayonet	22940	36
Osteotome 2.0/2.5, Round, Straight	22930	36
Osteotome 2.5/3.2, Concave, Bayonet	22941	36
Osteotome 2.5/3.2, Round, Straight	22931	36
Osteotome 3.2, Concave, Bayonet	22942	36
Osteotome 3.2, Round, Straight	22932	36
Osteotome 3.2/3.7, Concave, Bayonet	22943	36
Osteotome 3.2/3.7, Round, Straight	22933	36
Osteotome 3.2/4.3, Concave, Conical, Bayonet	22945	36
Osteotome 3.2/4.3, Round, Conical, Straight	22935	36
Osteotome 3.7, Concave, Bayonet	22944	36
Osteotome 3.7, Round, Straight	22934	36
Osteotome 3.7/4.2, Concave, Bayonet	24688	37
Osteotome 3.7/4.2, Round, Straight	24339	37
Osteotome 3.7/4.8, Concave, Conical, Bayonet	22946	36
Osteotome 3.7/4.8, Round, Conical, Straight	22936	36
Osteotome 4.2, Concave, Bayonet	24689	37
Osteotome 4.2, Round, Straight	24684	37
Osteotome 4.2/4.7, Concave, Bayonet	24690	37
Osteotome 4.2/4.7, Round, Straight	24685	37
Osteotome 4.7, Concave, Bayonet	24691	37
Osteotome 4.7, Round, Straight	24686	37
Osteotome Kit	22956	36
Osteotome Mallet, Small	22955	36
Osteotome Set 5.0 S, Concave	24692	37
Osteotome Set 5.0 S, Round	24687	37
Osteotome Set, Concave	22947	36
Osteotome Set, Round	22937	36
Osteotome Tray, Large	22953	37
Osteotome Tray, Small	24693	37
Paralleling Mandrel, Female	22371	30
Periotome Anterior, curved/straight edge	24275	34
Periotome Posterior, curved/straight edge	24274	34
Pilot Drill Ø 2.0/2.7 mm (light blue)	24795	41
Pilot Drill Ø 2.0/3.2 mm (green)	24207	41
Pilot Drill Ø 2.5/3.2 mm (green)	22803	41
Pilot Drill Ø 3.2/3.7 mm (black)	22805	41
Pilot Drill Ø 3.7/4.2, Yellow	22468	41
Polishing Protector Uni 20°	22471	48
Polishing Protector Uni 45°	22474	48



















	REF	page
Profile Bar Insert	22382	31
Profile Bar System	22381	31
RA Mucosal Punch 3.5/4.0	31267	43
RA Mucosal Punch 4.5/5.0	24803	43
Radiographic Implant Guides	24892	11
Ratchet Wrench	24357	34
Removal/Retrieval Kit	22864	50
Removal Tool M1.4 – Short	24021	51
Removal Tool M1.4 – Long	24037	51
Restorative Instrument Kit	24879	45
Restorative Tray	22495	45
Rider, Round Bar	22363	31
Round Bar	22362	31
Semi-Burnout Cylinder Angled	24243	25
Semi-Burnout Cylinder Uni 20°	22184	25
Semi-Burnout Cylinder Uni 45°	22185	25
Slot CA Driver – Long	22689	46
Slot CA Driver – Short	22688	47
Slot Screwdriver – Intermediate	22507	47
Slot Screwdriver – Long	22508	47
Slot Screwdriver – Short	22506	47
SP Conical Drill Ø 2.7/4.5 mm Long	25000	39
SP Conical Drill Ø 2.7/4.5 mm Short	24999	39
SP Conical Drill Ø 3.2/4.5 mm Short	22921	39
SP Conical Drill Ø 3.2/5.0 mm Long	25002	39
SP Conical Drill Ø 3.2/5.0 mm Short	25001	39
SP Conical Drill Ø 3.7/5.0 mm Short	22923	39
SP Conical Drill Ø 4.5 mm Long	22922	39
SP Conical Drill Ø 5.0 mm Long	22924	39
SP Cortical Drill Ø 2.7/3.0 mm Short	24998	39
SP Cortical Drill Ø 3.2/3.5 mm Short	22914	39
SP Cortical Drill Ø 3.5 mm Long	22915	39
SP Cortical Drill Ø 3.7/4.0 mm Short	22916	39
SP Cortical Drill Ø 4.0 mm Long	22917	39
SP Cortical Drill Ø 4.7/5.0 mm Short	22964	39
SP Drill Kit 6–13 mm	24737	38
SP Drill Kit, Long	22899	38
SP Drill Kit, Short	22898	38
SP Pilot Drill Ø 2.0/3.2, 6–13 mm	24735	39
SP Pilot Drill Ø 2.0/3.2 mm Long	22905	39
SP Pilot Drill Ø 2.0/3.2 mm Short	22904	39
SP Pilot Drill Ø 2.0/2.7 mm Short	24997	39
SP Pilot Drill Ø 3.2/3.7 mm Long	22907	39
SP Pilot Drill Ø 3.2/3.7 mm Short	22906	39
SP Pilot Drill Ø 3.7/4.2 mm Short	22963	39
SP Twist Drill Ø 2.0 mm Long	24991	39
SP Twist Drill Ø 2.0 mm Short	24992	39
SP Twist Drill Ø 2.7 mm Long	24993	39
SP Twist Drill Ø 2.7 mm Short	24994	39
SP Twist Drill Ø 2.85 mm Long	24995	39
SP Twist Drill Ø 2.85 mm Short	24996	39
SP Twist Drill Ø 3.35 mm Long	22909	39
SP Twist Drill Ø 3.35 mm Short	22908	39
SP Twist Drill Ø 3.7, 6–13 mm	24199	39
SP Twist Drill Ø 3.7 mm Long	22911	39
SP Twist Drill Ø 3.7 mm Short	22910	39
SP Twist Drill Ø 3.85 mm, 6–13 mm	24734	39
SP Twist Drill Ø 3.85 mm Long	22913	39
SP Twist Drill Ø 3.85 mm Short	22912	39
SP Twist Drill Ø 4.2 mm Long	22958	39
SP Twist Drill Ø 4.2 mm Short	22957	39
SP Twist Drill Ø 4.7 mm Long	22960	39
SP Twist Drill Ø 4.7 mm Short	22959	39
SP Twist Drill Ø 4.85 mm Long	22962	39
SP Twist Drill Ø 4.85 mm Short	22961	39
Suction Tube	68108	43
Suction Tube	68130	43
Suction Tube	68118	43
Surgical Instrument Kit	24980	33
Surgical Tray	24349	33
TempDesign™ 3.5/4.0	22851	14
TempDesign™ 4.5/5.0	22852	14
TempDesign™ 3.5/4.0 NI	22853	14
TempDesign™ 4.5/5.0 NI	22854	14
Temporary Abutment 3.0	25018	14
Temporary Abutment 3.5/4.0	24281	14

	REF	page
Temporary Abutment 3.5/4.0 NI	24280	14
Temporary Abutment 4.5/5.0	25015	14
Temporary Abutment 4.5/5.0 NI	25016	14
Temporary Cylinder Angled	22447	25
Temporary Cylinder Uni 20°	22060	25
Temporary Cylinder Uni 45°	22061	25
Thread Tap, 1.4 mm	22871	51
Thread Tap, 1.6 mm	22873	51
Thread Tap, 2.0 mm	22875	51
TiDesign™ 3.0 – Ø 4.0, 1 mm	24788	16
TiDesign™ 3.0 – Ø 4.0, 2 mm	24789	16
TiDesign™ 3.0 – Ø 4.0, 15°	24790	16
TiDesign™ 3.5/4.0 – Ø 4.5, 1.5 mm	24285	17
TiDesign™ 3.5/4.0 – Ø 4.5, 20°	24291	17
TiDesign™ 3.5/4.0 – Ø 4.5, 3 mm	24286	17
TiDesign™ 3.5/4.0 – Ø 5.5, 1.5 mm	24287	17
TiDesign™ 3.5/4.0 – Ø 5.5, 20°	24292	17
TiDesign™ 3.5/4.0 – Ø 5.5, 3 mm	24288	17
TiDesign™ 3.5/4.0 – Ø 6.5, 1.5 mm	24289	17
TiDesign™ 3.5/4.0 – Ø 6.5, 3 mm	24290	17
TiDesign™ 4.5/5.0 – Ø 5.5, 1.5 mm	24235	17
TiDesign™ 4.5/5.0 – Ø 5.5, 20°	24239	17
TiDesign™ 4.5/5.0 – Ø 5.5, 3 mm	24236	17
TiDesign™ 4.5/5.0 – Ø 6.5, 1.5 mm	24237	17
TiDesign™ 4.5/5.0 – Ø 6.5, 3 mm	24238	17
Titanium Bowl	22137	34
Titanium Cylinder Angled	24244	25
Titanium Cylinder Uni 20°	22798	25
Titanium Cylinder Uni 45°	22799	25
Ti-ZirDesign™ 3.5/4.0 Try-in	24847	46
Ti-ZirDesign™ 4.5/5.0 Try-in	24849	46
Torque Wrench	24075	46
Torque Wrench Bit Hex, Short	24093	45
Torque Wrench Bit Hex, Long	24094	45
Torque Wrench Bit Slot, Short	24095	45
Torque Wrench Bit Slot, Long	24096	45
Torque Wrench Connector, Adapter	24097	45
Torque Wrench Instrument Lubricant	24098	45
Torque Wrench Dismantle Tool	24099	45
Torque Wrench Kit	24100	45

	REF	page
Trephine Drill, Ø 3.5	22884	50
Trephine Drill, Ø 4.0	22885	50
Trephine Drill, Ø 5.0	22890	50
Try-in Kit Direct Abutment	24839	46
Twist Drill Ø 2.0, 8–13 mm (no color) Short	22887	40
Twist Drill Ø 2.5, 8–13 mm (red) Short	22802	40
Twist Drill Ø 2.7, 8–19 mm (light blue) Long	24796	40
Twist Drill Ø 2.7, 8–13 mm (light blue) Short	24797	40
Twist Drill Ø 2.85, 8–19 mm (silver) Long	24798	40
Twist Drill Ø 2.85, 8–13 mm (silver) Short	24799	40
Twist Drill Ø 3.2, 8–13 mm (green) Short	22811	40
Twist Drill Ø 3.35, 8–13 mm (lilac) Short	22812	40
Twist Drill Ø 3.7, 8–13 mm (black) Short	22813	40
Twist Drill Ø 3.85, 8–13 mm (brown) Short	22814	40
Twist Drill Ø 4.2, 8–13 mm (yellow) Short	22463	40
Twist Drill Ø 4.2, 8–19 mm (yellow) Long	22462	40
Twist Drill Ø 4.7, 8–19 mm (blue) Long	22464	40
Twist Drill Ø 4.7, 8–13 mm (blue) Short	22465	40
Twist Drill Ø 4.85, 8–19 mm (pink) Long	22466	40
Twist Drill Ø 4.85, 8–13 mm (pink) Short	22467	40
Twist Drill Ø 2.0, 8–19 mm (no color) Long	22886	40
Twist Drill Ø 2.5, 8–19 mm (red) Long	22801	40
Twist Drill Ø 3.2, 8–19 mm (green) Long	22807	40
Twist Drill Ø 3.35, 8–19 mm (lilac) Long	22808	40
Twist Drill Ø 3.7, 8–19 mm (black) Long	22809	40
Twist Drill Ø 3.85, 8–19 mm (brown) Long	22810	40
UniAbutment Retriever	22429	51
Wrench	22124	35
Wrench Adapter	24572	34
ZirDesign™ 3.5/4.0 – Ø 4.4, 1.5 mm	24702	16
ZirDesign™ 3.5/4.0 – Ø 4.5, 3 mm	24703	16
ZirDesign™ 3.5/4.0 – Ø 5.5, 1.5 mm	24704	16
ZirDesign™ 3.5/4.0 – Ø 5.5, 3 mm	24705	16
ZirDesign™ 3.5/4.0 – Ø 5.5, 3.5 mm, 20°	24706	16
ZirDesign™ 4.5/5.0 – Ø 5.5, 1.5 mm	24707	16
ZirDesign™ 4.5/5.0 – Ø 5.5, 3 mm	24708	16
ZirDesign™ 4.5/5.0 – Ø 6.5, 1.5 mm	24709	16
ZirDesign™ 4.5/5.0 – Ø 6.5, 3 mm	24710	16
ZirDesign™ 4.5/5.0 – Ø 5.5, 3.5 mm, 20°	24711	16

Torque guide

Recommended tightening torque















Type of product	Torque – Ncm			
	X-Small	Small	Large	
Cover Screw Healing Abutment Healing Abutment Uni ProHeal Cap Healing Cap Angled	    	Manual* Manual** Manual** Manual**	Manual* Manual** Manual** Manual**	Manual* Manual** Manual** Manual**
TempDesign™ Temporary Abutment 20°/45° Cresco™ Insert for ASTRA TECH Implant System™ 20°/45° UniAbutment Bridge Screws Cresco™ Bridge Screw	     	– 15 – –	15 15 15 15	15 15 15 15
ATLANTIS™ abutment for ASTRA TECH Implant System™ ZirDesign™ TiDesign™ CastDesign™ Angled Abutment	    	15***	20	25
Direct Abutment™ Ball Abutment Locator™ Abutment	  	–	25	25

* Only light fingerforce (5–10 Ncm) using a manual screwdriver or contra angle preset at 25 rpm and 5–10 Ncm torque.

** Only light fingerforce (5–10 Ncm) using a manual screwdriver. Do not use a Ratchet Wrench or Torque Wrench.

*** **Note:** Available for TiDesign, ATLANTIS abutment, titanium and ATLANTIS abutment, GoldHue.

Explanation of the symbols on labels and instructions for use

Symbol	Text	Symbol	Text
 Date of manufacture	Date of manufacture.		ASTRA TECH Implant System products carry the CE mark and fulfill the requirements of the medical devices directive.
 Use by	Expire date.	 Do not use if package is damaged	Do not use if package is damaged.
	Sterilized using irradiation.	 Consult instructions for use	Consult instructions for use.
	Caution: Federal (USA) law restrict this product to sale by or on a order of a dentist.		Consult instructions for use.
 Single use	Do not re-use, Single use only.		LOT/BATCH number.
 Do not re-sterilize	Do not re-sterilize.		Article number.
	GOST is the valid quality certification system in Russian Federation.		Contains article number (GTIN number), lot number and quantity.



ASTRA TECH IMPLANT SYSTEM BioManagement Complex™

A successful implant system cannot be determined by one single feature alone. Just as in nature, there must be several interdependent features working together. The following combination of key features is unique to the ASTRA TECH Implant System:

- **OsseoSpeed™** — more bone more rapidly
- **MicroThread™** — biomechanical bone stimulation
- **Conical Seal Design™** — a strong and stable fit
- **Connective Contour™** — increased soft tissue contact zone and volume

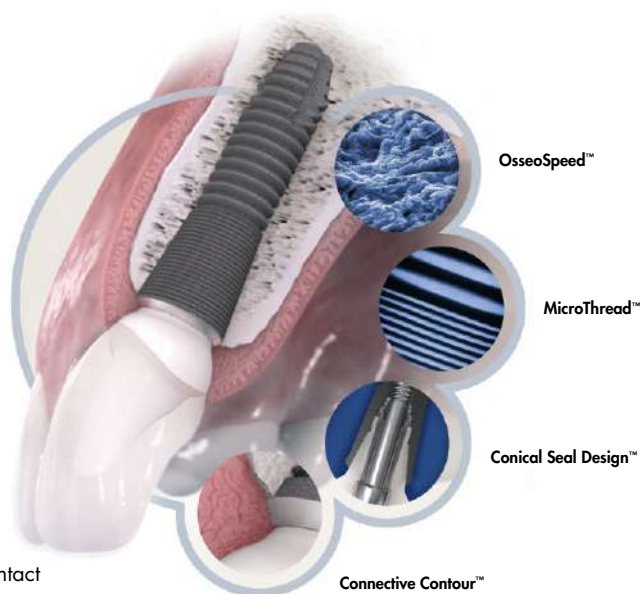

About DENTSPLY Implants

DENTSPLY Implants offers comprehensive solutions for all phases of implant therapy, including ANKYLOS®, ASTRA TECH Implant System™ and XiVE® implant lines, digital technologies, such as ATLANTIS™ patient-specific CAD/CAM solutions and SIMPLANT® guided surgery, regenerative bone materials, and professional development programs. DENTSPLY Implants creates value for dental professionals and allows for predictable and lasting implant treatment outcomes, resulting in enhanced quality of life for patients.

About DENTSPLY International

DENTSPLY International Inc. is a leading manufacturer and distributor of dental and other healthcare products. For over 110 years, DENTSPLY's commitment to innovation and professional collaboration has enhanced its portfolio of branded consumables and small equipment. Headquartered in the United States, the Company has global operations with sales in more than 120 countries.