



Astra Tech Implant System®

Manual and product catalog

OsseoSpeed® TX Profile



Adapting with nature

OsseoSpeed® TX Profile – anatomically designed implants for sloped ridges

Imagine being able to achieve 360° bone preservation around the implant, even in cases with sloped ridges. Now you can.

With OsseoSpeed TX Profile – a uniquely shaped, patented implant, specifically designed for sloped ridge situations – you no longer have to choose between buccal and lingual marginal bone preservation and esthetics, you can have it all – 360° around the implant.

Astra Tech Implant System®

CONTENTS

Introduction	4
Implant overview	5
Intended use	5
OsseoSpeed® TX Profile assortment	5
Clinical considerations	6
Pre-operative procedures	6
Implant positioning	6
Surgical overview	7
OsseoSpeed® TX Profile – surgical handling	7
OsseoSpeed® TX Profile – dimensions	7
Step-by-step procedures	8
Restorative overview	12
Step-by-step procedures	12
Cement-retained restorations	14
Screw-retained restorations	14
Torque guide	15
Explanation of the symbols on labels and instructions for use	15
Product catalog	16
Index	22

This manual is designed for dental professionals who have experience with dental implant treatment and as a complement to the surgical and restorative manuals for the Astra Tech Implant System. It highlights and emphasizes the special considerations needed when planning and performing treatment with OsseoSpeed TX Profile implants.

To improve readability for our customers, Dentsply Sirona does not use ® or ™ in body copy. However, Dentsply Sirona does not waive any right to the trademark and nothing herein shall be interpreted to the contrary.

Introduction

The applications of osseointegration and dental implant therapy have developed over the last 30 years. Today we can provide predictable and reliable treatment results when replacing missing teeth with dental implants. Research and development have improved implant design and surface properties and effective and secure treatment protocols have been established. For over twenty-five years, we have been committed to developing implant features that work in harmony with nature. Long-term documentation on the Astra Tech Implant System proves our success, not only in implant survival, but also in predictable peri-implant marginal bone stability.

However, how well the implant adapts to the profile of the alveolar ridge, is an area that has been overlooked. With today's implant design, an optimal bone/implant relation is only possible when the peri-implant bone is at the same level around the implant neck.



Compromised implant placement with a sloped alveolar ridge

An implant placed in level with the buccal bone margin leaves the lingual/palatal and proximal bone coronal to the implant without biomechanical support. We can foresee remodeling and loss of bone and soft tissue height, resulting in less than optimal esthetic results.



An implant placed in level with the palatal/lingual bone margin leaves the implant protruding out of the bone on the buccal side. This can result in discoloration of the buccal soft tissue margin or, in a worst-case scenario, a soft tissue dehiscence, causing compromised esthetics.



Neither of these alternatives are optimal.

OsseoSpeed® TX Profile

The optimal solution in a sloped ridge situation is to have a sloped implant that is designed to be in harmony with the ridge profile, preserves the marginal bone and supports the soft tissue all around the implant.



The Astra Tech Implant System, with its BioManagement Complex, is documented to provide marginal bone level maintenance. The OsseoSpeed TX Profile is a result of a small modification to the OsseoSpeed TX implant design that makes a big difference for providing long-term esthetic results in sloped ridge situations.



Implant overview

OsseoSpeed TX Profile implants are based on the documented key features and benefits of the Astra Tech Implant System BioManagement Complex; OsseoSpeed, MicroThread, Conical Seal Design and Connective Contour.

Intended use

The intended use for OsseoSpeed TX Profile is the same as for OsseoSpeed TX. In addition, the OsseoSpeed TX Profile is specially designed to be used in situations with a sloped ridge profile in:

- healed alveolar ridges
- extraction sockets (immediate installation)

OsseoSpeed® TX Profile	<p style="text-align: center;">4.5</p> <p style="text-align: center;">4.5 mm</p>  <p style="text-align: center;">1.9 mm</p>	<p style="text-align: center;">5.0</p> <p style="text-align: center;">5.0 mm</p>  <p style="text-align: center;">2.4 mm</p>	<p style="text-align: center;">5.0 S</p> <p style="text-align: center;">5.0 mm</p>  <p style="text-align: center;">3.2 mm</p>
Indications	<p>In all positions in the jaws.</p> <p>Single tooth to full arch.</p>	<p>In all positions in the jaws.</p> <p>Single tooth to full arch.</p>	<p>In all positions in the jaws. Especially indicated for wide ridges and large edentulous spaces.</p> <p>Single tooth to full arch.</p>

OsseoSpeed® TX Profile assortment

Components specifically designed for use with OsseoSpeed TX Profile implants are presented in this manual/product catalog. Do not interchange components designed for the OsseoSpeed TX Profile and OsseoSpeed TX, with the exception of the Healing Abutment and Healing Abutment Uni assortments for OsseoSpeed TX 4.5/5.0, which are verified products also for the OsseoSpeed TX Profile.

OsseoSpeed TX Profile products and packaging are not color-coded and therefore, labels are white.

This manual only addresses the additional information needed to work with the OsseoSpeed TX Profile and optimize the final outcome when using this implant.

For all other instructions and/or a full description of the Astra Tech Implant System implant placement, restorative procedures and all instruments and components needed, please refer to the Surgical procedure manual, Cement-retained restorations manual and the Product catalog.

If you are not familiar with Atlantis abutments, please contact your laboratory and/or your local representative. For more information visit www.atlantisabutment.com.



Clinical consideration

To take full advantage of all the benefits of the OsseoSpeed TX Profile, please note the important steps in the treatment process, including pre-operative procedures and implant positioning.

Pre-operative procedures

Transparent Radiographic Implant Guides for OsseoSpeed TX Profile that present the implants in different magnifications, are available for preoperative planning. A sagittal tomographic radiograph showing an appropriate view of the ridge profile could be useful for planning the optimal implant position and direction. Computer guided implant treatment software, such as Facilitate, can also be helpful in ensuring accurate planning for optimal implant position.

Implant positioning

Only one position of the implant slope is optimal i.e. correct vertical and rotational position in relation to the buccal bone. Therefore, careful drilling and implant placement procedures, particularly for the OsseoSpeed TX Profile 4.5 and 5.0 (conical) implants are required. Over-torquing may jeopardize marginal bone integrity due to unfavorable stress generation. Place the implant in line with the buccal bone level to provide support of the marginal bone around the implant. It is important to note that a full 360° turn is equal to a 0.6 mm change in vertical position.



Surgical overview

OsseoSpeed® TX Profile – surgical handling

The same handling procedure as for the OsseoSpeed TX implants applies. However, steps such as preparation and measuring of the osteotomy and the implant placement require more specific protocols.

From a mechanical strength point of view, it is recommended to always place as wide an implant as possible. This is particularly important in the posterior regions of the jaws where loading forces are high and considerable bending moments could be generated.

Implant slope variance

As a result of the sloped neck design, the height of the lingual/palatal side as compared to the buccal side of the implant has a variance of 1.5 -1.7 mm depending on the implant diameter, as illustrated below:

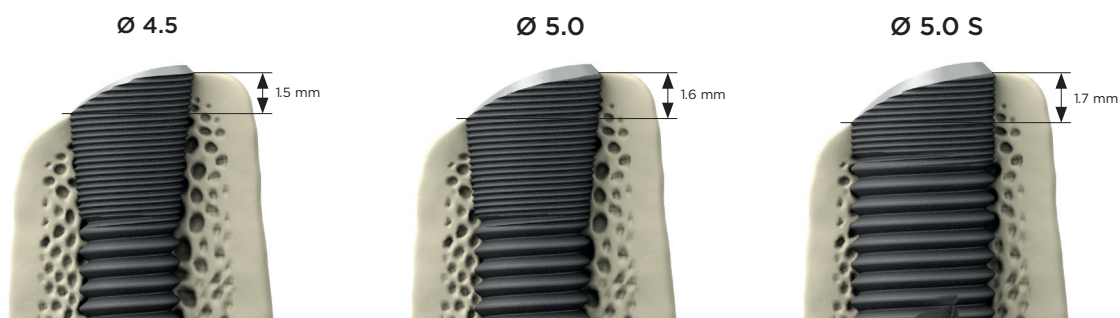

Drill depth requirements

In relation to the buccal wall of the prepared site, the required drill depth should be **no more than 1.5 mm shorter** than the implant length (i.e.: for a 13 mm implant, a drill depth minimum of 11.5 mm on the buccal wall is necessary.)

Note: A full 360° turn of the implant is equal to a 0.6 mm change in vertical position.

Step-by-step drilling procedure for OsseoSpeed® TX Profile 5.0, 13 mm - standard drilling protocol*

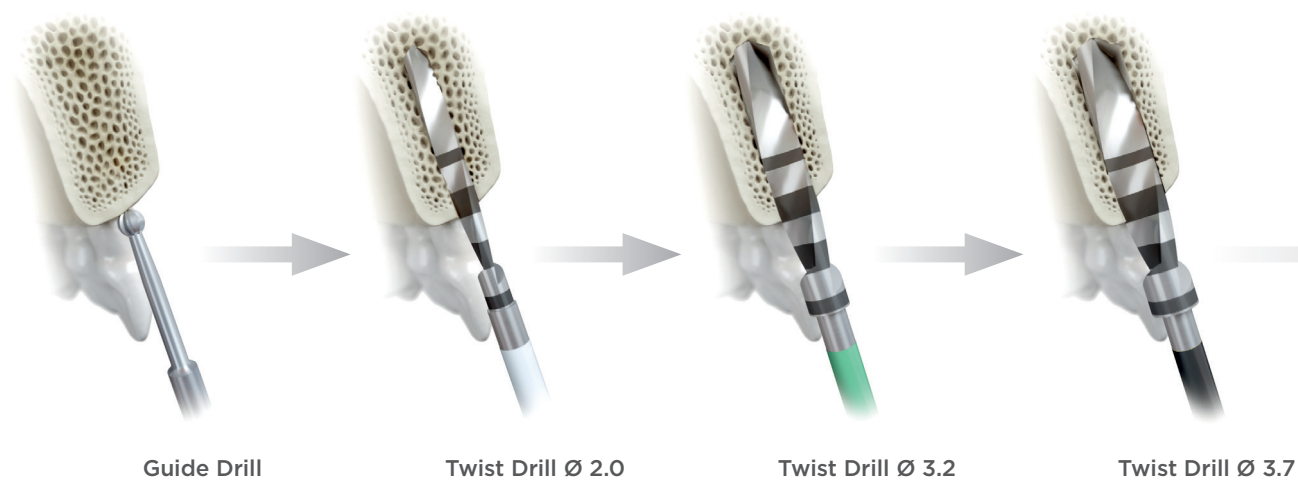

- The starting point should be approximately 3 mm buccally to the most coronal point of the ridge.

*For soft and dense bone drilling protocols, see Surgical procedures manual.



- For standard drilling protocol, drill to the beginning of the depth indication line.



Implant Depth Gauge palatal

- Place the Depth Gauge against the palatal and the buccal walls of the osteotomy to verify the drilling depth.



Implant Depth Gauge buccal

- Make sure there is enough depth provided for the entire implant. For the 5.0,13 mm implant, the buccal depth should be at least 11.5 mm.
- If the depth is less than 11.5 mm, additional drilling with a twist drill is required, and may be followed by the conical drill depending on the clinical situation.
- If the depth for the 5.0,13 mm implant, is more than 11.5 mm, make sure to stop the implant installation at or slightly apical to the buccal margin.

Step-by-step implant placement procedure for OsseoSpeed® TX Profile Ø 5.0 mm, 13 mm



Pick-up

- Attach the Implant Driver Profile to the Contra Angle.
- Align the black/flat marking on Implant Driver Profile with the most apical point of the implant slope. Make sure that the driver is properly seated.
- Pick up the implant from the inner container.

Installation

- Install the implant with a contra angle at low speed (25 rpm) under profuse irrigation.
- Set the maximum torque to 35 Ncm. Let the implant work its way into the osteotomy and avoid applying unnecessary pressure.
- Keep in mind the position of the buccal side of the implant before removing the driver.

Positioning

- The Ratchet Wrench, in combination with the Driver Handle, may be used for the final manual seating of the implant.
- Position the marking on the driver buccally to facilitate optimal placement of the implant.
- The driver must be properly seated to be used for measuring purposes.
- It is important to realize that a full 360° turn is equal to a 0.6 mm change in vertical position.
- Release the Implant Driver Profile by lifting it gently from the implant.

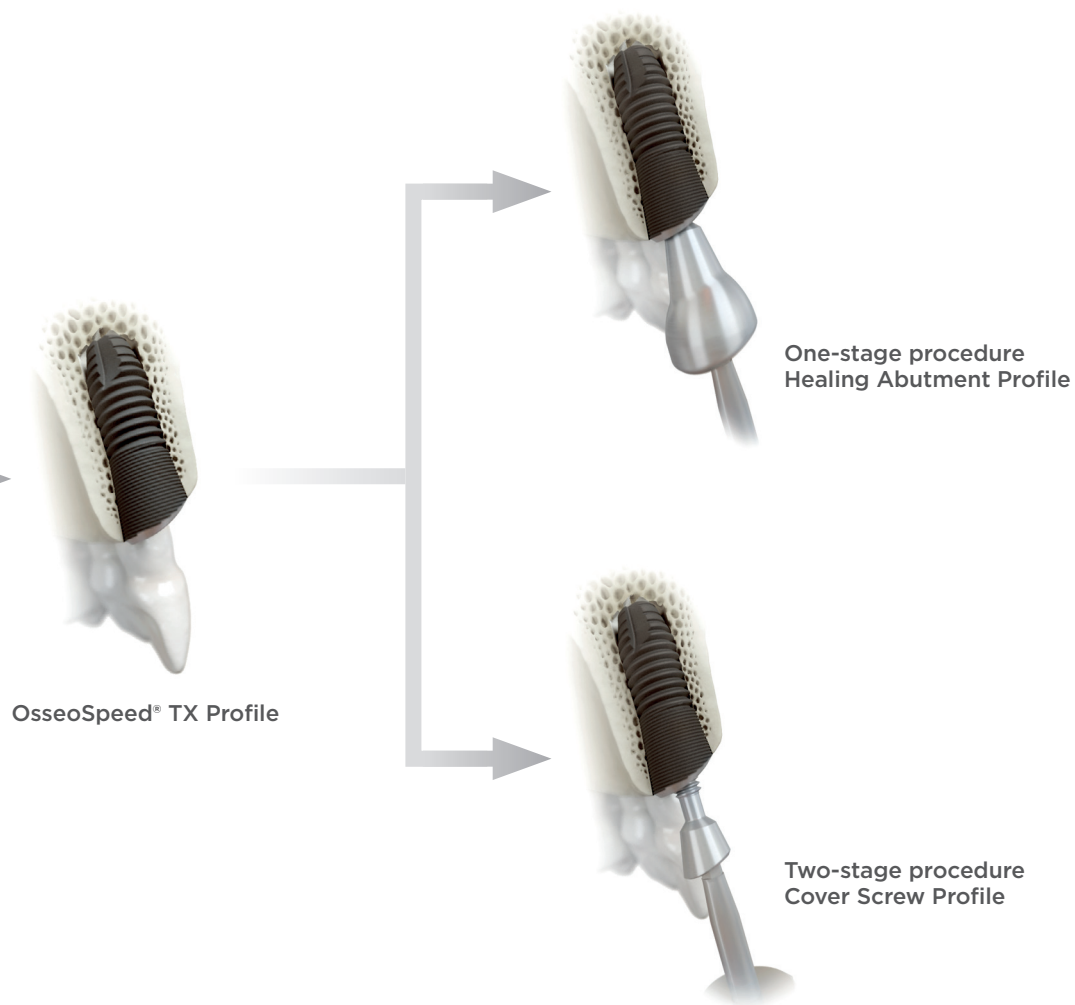

- Healing Abutment Profile and Cover Screw Profile have timed threading to ensure correct alignment with the implant slope.
- Use finger force (5–10 Ncm) to seat the healing abutment or cover screw with a Hex Screwdriver.
- When placing the healing abutment or cover screw, be sure not to use a torque that might create further rotation of the implant.

Step-by-step implant-level impression procedure for OsseoSpeed® TX Profile

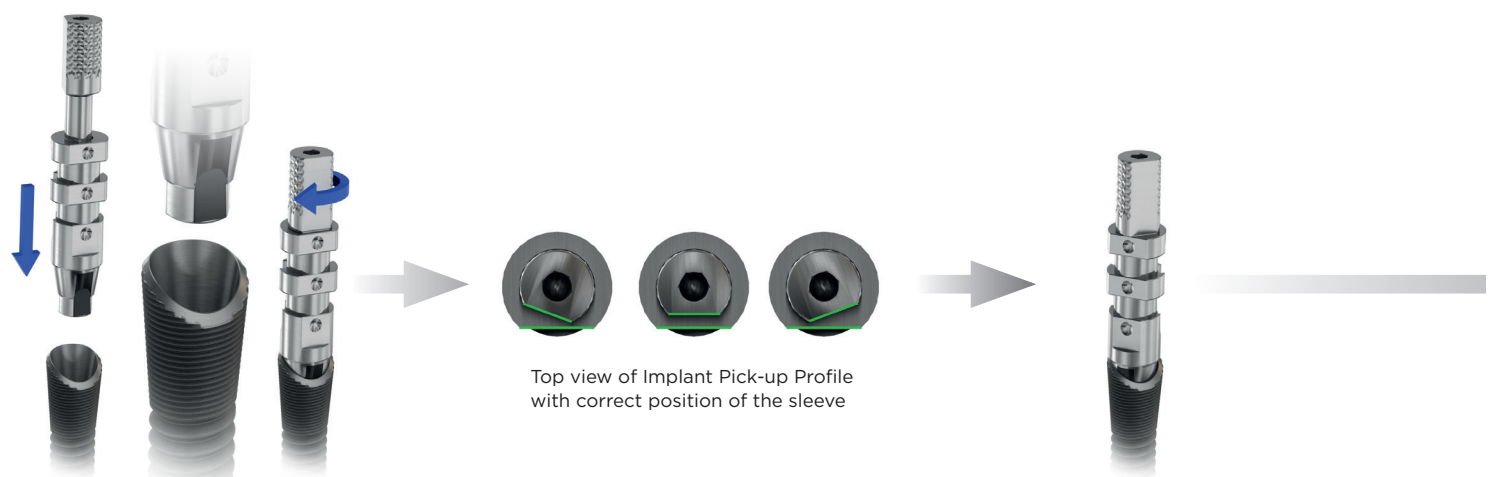

Implant impression – open tray technique

- Align the flat surface of the Implant Pick-up sleeve with the most apical point of the implant slope.
- Keep the sleeve in position and tighten the pin using finger force.

Confirmation

- The correct rotational position of the sleeve is verified by the flat surface of the pin aligned within the area of the flat surface on the sleeve.

Note: It is important that the clinician communicates the information about the placed OsseoSpeed TX Profile implant to the dental technician for correct implant replica and appropriate abutment.

Correction

- In case of misalignment between the flat surfaces of the sleeve and pin, the rotational position of the sleeve is not correct.
- The flat surface of the pin indicates the most apical point of the implant slope.
- Untighten the impression pin.
- Lift and rotate the sleeve.
- Keep the sleeve in position and tighten the pin using finger force.

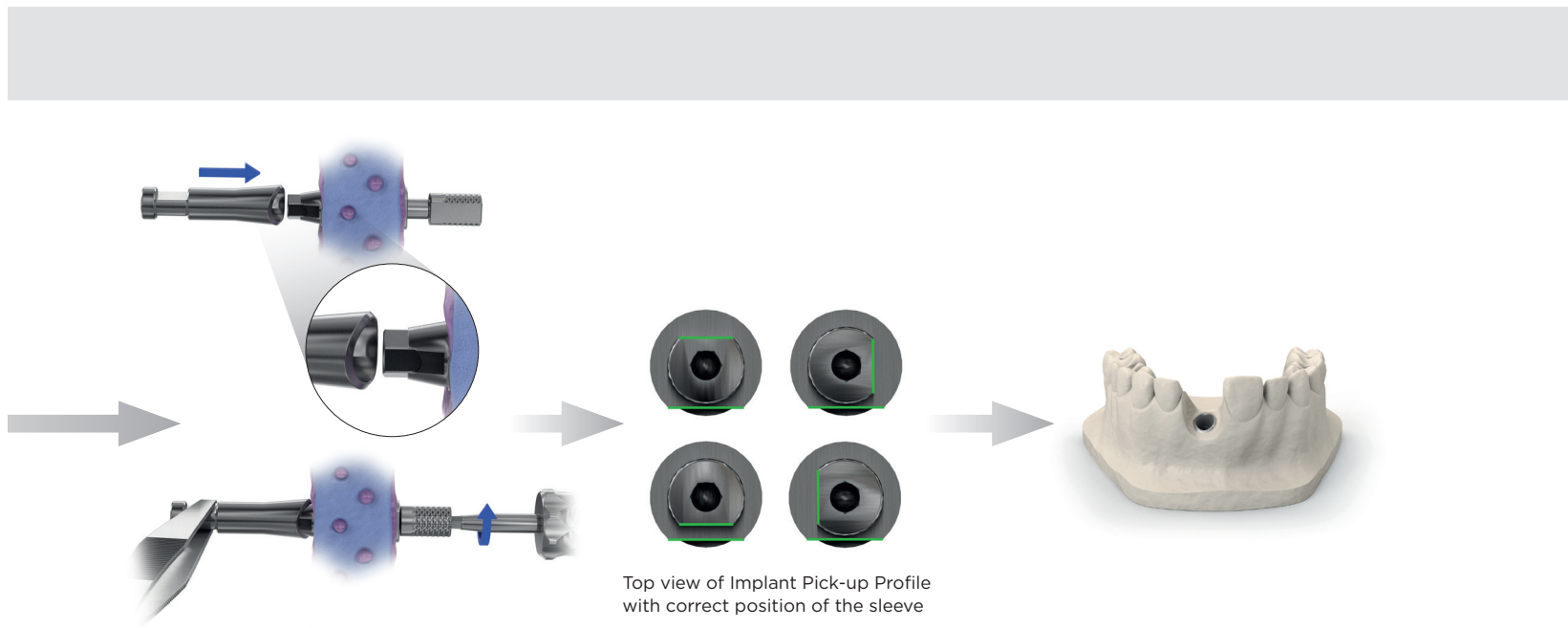

Lab procedure

- Pull back the pin before seating the Implant Pick-up Profile on the Implant Replica Profile.
- Align the most apical point of the replica slope with the black marked area of the hexagon on the pick-up.
- Hold the replica in a firm grip during tightening of the pin with the Hex Screwdriver.

Important

- The flat surface on the pin may not align with the flat surface on the sleeve when the Implant Pick-up Profile is mounted in the Implant Replica Profile.



Prosthetic restoration

- The pin included in the Implant Pick-up Profile works only assembled with the sleeve.
- During laboratory work use a separate Implant Guide Pin or Laboratory Abutment Screw when securing the abutment.
- Specific abutments are used for OsseoSpeed TX Profile.

Cement-retained restorations

The same handling procedures apply as for the OsseoSpeed TX implants. The following cement-retained restorative options are available for OsseoSpeed TX Profile.

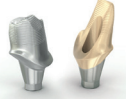

Abutments designed for implant-level impression	Clinical application	Features and benefits
<p>Atlantis® Abutment* Titanium Gold-shaded titanium</p> 	<ul style="list-style-type: none"> • Single, partial and fully edentulous situations • All positions in the mouth 	<ul style="list-style-type: none"> • Patient-specific abutment designed from the final tooth shape
<p>TiDesign™ Profile Titanium</p> 	<ul style="list-style-type: none"> • Single, partial and fully edentulous situations • All positions in the mouth 	<ul style="list-style-type: none"> • Pre-designed and for easy adjustment • Straight and angled versions available
Abutment for Temporization	Clinical application	Features and benefits
<p>Temporary Abutment Profile Titanium</p> 	<ul style="list-style-type: none"> • Single, partial and fully edentulous situations • All positions in the mouth • Cement- and screw-retained temporary restorations 	<ul style="list-style-type: none"> • Ideal for long-term temporization

*For the available options, please refer to the most current Atlantis Implant compatibility chart.

Laboratory Abutment Screw



To ensure that an uncompromised screw is used in the clinical situation, use the Laboratory Abutment Screw for laboratory procedures.

Implant-level impression

Use the Implant Pick-up Profile (open-tray technique) for implant-level impressions. For the working model use the Implant Replica Profile.





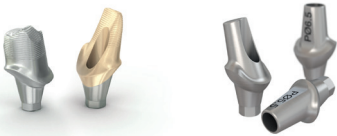



In cases where an open-tray impression technique is not possible, an Implant Transfer Profile is available. Rotate the sleeve until it drops down and is seated in the correct position. Keep the sleeve down while tightening the pin. Following removal of impression, unscrew the Implant Transfer Profile. Connect the Implant Replica Profile to the Implant Transfer Profile with the two sloped surfaces aligned and reposition the assembly in the impression.

Torque guide for OsseoSpeed® TX Profile assortment

Type of product		Torque - Ncm
Cover Screw Profile Healing Abutment Profile		Only finger force (5-10 Ncm) using a manual screwdriver.
Temporary Abutment Profile		15
Atlantis® Abutment TiDesign™ Profile		25

Explanation of the symbols on labels and instructions for use

Symbol	Text
	Date of manufacture.
	Legal manufacturer
	Expired date.
	Sterilized using irradiation.
	Caution: Federal (USA) law restricts this product to sale by or on a order of a dentist.
	Do not re-use, Single use only.
	Do not re-sterilize.
	GOST is the valid quality certification system in Russian Federation.

Symbol	Text
	Astra Tech Implant System® products carry the CE mark and fulfill the requirements of the Medical Devices Directive.
	Do not use if package is damaged.
	For instructions for use and symbols glossary refer to ifu.dentsplysirona.com
	Consult instructions for use.*
	Consult instructions for use.
	LOT/BATCH number.
	Article number.
	Contains article number (GTIN number), lot number and quantity.

* To read PDF files you will need Adobe Reader. Download free of charge at get.adobe.com/reader.

Product catalog

OsseoSpeed® TX Profile

Components specifically designed for use with OsseoSpeed TX Profile implants are presented in this manual/product catalog. Do not interchange components designed for the OsseoSpeed TX Profile and OsseoSpeed TX, with the exception of the Healing Abutment and Healing Abutment Uni assortments for OsseoSpeed TX 4.5/5.0, which are verified products also for the OsseoSpeed TX Profile. Products and packaging for OsseoSpeed TX Profile are not color-coded and therefore, labels are white.

If you need drills and other instruments, please refer to the Product catalog for Astra Tech Implant System. If you are not familiar with Atlantis abutments, please contact your laboratory and/or your local representative.

For more information visit www.atlantisabutment.com.



Product overview

OsseoSpeed® TX Profile

Implants

OsseoSpeed® TX Profile 4.5



9 mm 25029
11 mm 25030
13 mm 25031
15 mm 25032
17 mm 25033

OsseoSpeed® TX Profile 5.0



9 mm 25034
11 mm 25035
13 mm 25036
15 mm 25037
17 mm 25038

OsseoSpeed® TX Profile 5.0 S



9 mm 25039
11 mm 25040
13 mm 25041
15 mm 25042
17 mm 25043

Cover screws

Cover Screw Profile



0 mm 25044









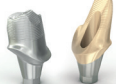

Healing abutments

Healing Abutment Profile

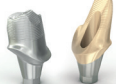

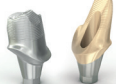
Ø 6.0 2 mm 25045
Ø 6.0 4 mm 25046

Cement-retained

<h4 style="text-align: center;">Temporary abutments</h4> <p style="text-align: center;">Temporary Abutment Profile</p>  <p style="text-align: center;">Ø 5.3 1.5 mm 25052</p>	<h4 style="text-align: center;">Abutments</h4> <table style="width: 100%; border: none;"> <tr> <td style="width: 50%; text-align: center;"> <p>TiDesign™ Profile</p>  <table style="width: 100%; border: none;"> <tr> <td>Ø 5.5</td> <td>1.8 mm</td> <td>25053</td> </tr> <tr> <td>Ø 5.5</td> <td>3.0 mm</td> <td>25054</td> </tr> <tr> <td>Ø 6.5</td> <td>1.8 mm</td> <td>25055</td> </tr> <tr> <td>Ø 6.5</td> <td>3.0 mm</td> <td>25056</td> </tr> <tr> <td>Ø 6.2 15°</td> <td>2.7 mm</td> <td>25057</td> </tr> </table> </td> <td style="width: 50%; text-align: center;"> <p>Atlantis® Abutments*</p>  </td> </tr> </table>	<p>TiDesign™ Profile</p>  <table style="width: 100%; border: none;"> <tr> <td>Ø 5.5</td> <td>1.8 mm</td> <td>25053</td> </tr> <tr> <td>Ø 5.5</td> <td>3.0 mm</td> <td>25054</td> </tr> <tr> <td>Ø 6.5</td> <td>1.8 mm</td> <td>25055</td> </tr> <tr> <td>Ø 6.5</td> <td>3.0 mm</td> <td>25056</td> </tr> <tr> <td>Ø 6.2 15°</td> <td>2.7 mm</td> <td>25057</td> </tr> </table>	Ø 5.5	1.8 mm	25053	Ø 5.5	3.0 mm	25054	Ø 6.5	1.8 mm	25055	Ø 6.5	3.0 mm	25056	Ø 6.2 15°	2.7 mm	25057	<p>Atlantis® Abutments*</p> 
<p>TiDesign™ Profile</p>  <table style="width: 100%; border: none;"> <tr> <td>Ø 5.5</td> <td>1.8 mm</td> <td>25053</td> </tr> <tr> <td>Ø 5.5</td> <td>3.0 mm</td> <td>25054</td> </tr> <tr> <td>Ø 6.5</td> <td>1.8 mm</td> <td>25055</td> </tr> <tr> <td>Ø 6.5</td> <td>3.0 mm</td> <td>25056</td> </tr> <tr> <td>Ø 6.2 15°</td> <td>2.7 mm</td> <td>25057</td> </tr> </table>	Ø 5.5	1.8 mm	25053	Ø 5.5	3.0 mm	25054	Ø 6.5	1.8 mm	25055	Ø 6.5	3.0 mm	25056	Ø 6.2 15°	2.7 mm	25057	<p>Atlantis® Abutments*</p> 		
Ø 5.5	1.8 mm	25053																
Ø 5.5	3.0 mm	25054																
Ø 6.5	1.8 mm	25055																
Ø 6.5	3.0 mm	25056																
Ø 6.2 15°	2.7 mm	25057																
<h4 style="text-align: center;">Implant impressions</h4> <p style="text-align: center;">Implant Pick-up Profile</p>  <p style="text-align: center;">Short 24986 Long 24985</p>	<h4 style="text-align: center;">Guide pins</h4> <p style="text-align: center;">Implant Guide Pin 4.5/5.0</p>  <p style="text-align: center;">Short 24966 Long 24967</p>																	
<h4 style="text-align: center;">Replicas</h4> <p style="text-align: center;">Implant Replica Profile</p>  <p style="text-align: center;">25047</p>	<h4 style="text-align: center;">Lab abutment screws</h4> <p style="text-align: center;">Lab Abutment Screw Design 4.5/5.0</p>  <p style="text-align: center;">24858</p>																	

*For the available options, please refer to the most current Atlantis Implant compatibility chart.

Note: Healing Abutment and Healing Abutment Uni assortments for OsseoSpeed TX 4.5/5.0 can be used with OsseoSpeed TX Profile implants.

Surgical components

OsseoSpeed® TX Profile 4.5

Titanium, Sterile

OsseoSpeed®, with a TiO₂-blasted fluoride-modified surface.

MicroThread™ neck.

Conical Seal Design™ connection.

Internal hexagon.

Ø 4.5/3.5 mm

Internal thread M2

OsseoSpeed® TX Profile 4.5



Length mm	9	11	13	15	17
Order no.	25029	25030	25031	25032	25033

OsseoSpeed® TX Profile 5.0

Titanium, Sterile

OsseoSpeed®, with a TiO₂-blasted fluoride-modified surface.

MicroThread™ neck.

Conical Seal Design™ connection.

Internal hexagon.

Ø 5.0/4.0 mm

Internal thread M2

OsseoSpeed® TX Profile 5.0



Length mm	9	11	13	15	17
Order no.	25034	25035	25036	25037	25038

OsseoSpeed® TX Profile 5.0 S

Titanium, Sterile

OsseoSpeed®, with a TiO₂-blasted fluoride-modified surface.

MicroThread™ neck.

Conical Seal Design™ connection.

Internal hexagon.

Ø 5.0 mm

Internal thread M2

OsseoSpeed® TX Profile 5.0 S



Length mm	9	11	13	15	17
Order no.	25039	25040	25041	25042	25043

Radiographic Implant Guides Profile

Radiographic Implant Guides Profile



Order no.	25062
-----------	-------

Implant Driver Profile

Used to engage and place implants.

Short drivers are ideal for the posterior region.

Implant Driver Profile



	Short	Long
Length mm	24	32
Order no.	25059	25058

Cover Screw Profile



Ø mm	3.8
Height mm	0
Order no.	25044

Cover Screw Profile

Titanium, Sterile

Used to cover the implant connection during healing.

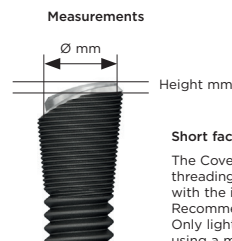

Short facts
The Cover Screw Profile has timed threading to ensure correct alignment with the implant slope. Recommended torque – Manual. Only light finger force (5-10 Ncm) using a manual screwdriver.

Healing Abutment Profile



Ø mm	6.0	6.0
Height A mm	2	4
Height B mm	3.5	5.5
Order no.	25045	25046

Healing Abutment Profile

Titanium, Sterile

Note: Healing Abutment and Healing Abutment Uni assortments for OsseoSpeed TX 4.5/5.0 can be used with OsseoSpeed TX Profile implants.

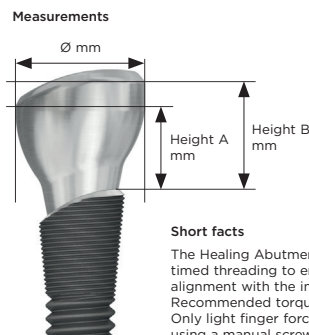

Short facts
The Healing Abutment Profile has timed threading to ensure correct alignment with the implant slope. Recommended torque – Manual. Only light finger force (5-10 Ncm) using a manual screwdriver.



Marked with a "P" to identify Profile abutment. Marked with digits to identify diameter (Ø) and height.

Temporary Abutment Profile



Ø mm	5.3
Height bucc A mm	1.5
Height ling B mm	1.5
Vert. height mm	9
Order no.	25052

Temporary Abutment Profile

Titanium

Includes Abutment Screw Design 4.5/5.0 – M2, REF 24209 (Titanium)

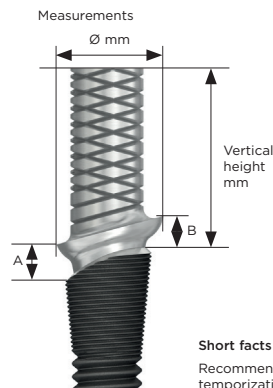

Short facts
Recommended torque for temporization – 15 Ncm

Restorative components

Implant Pick-up Profile

Titanium

Two piece component: sleeve and guide pin.



Short facts

The Implant Pick-up Profile sleeve is marked with a black and flat surface to align with the most apical point of the implant slope.

Implant Pick-up Profile



	Short	Long
Length mm	22	27
Order no.	24986	24985

Implant Replica Profile

Titanium



Implant Replica Profile

Length mm	15.5
Order no.	25047

Implant Guide Pin 4.5/5.0

Titanium



Implant Guide Pin 4.5/5.0

	Short	Long
Length mm	22	27
Order no.	24966	24967

Lab Abutment Screw Design

Titanium

QTY 6 x M2



Lab Abutment Screw Design

Order no.	24858
-----------	-------

TiDesign™ Profile 4.5/5.0



Angulation					15°
Ø mm	5.5	5.5	6.5	6.5	6.2
Height bucc A mm	1.8	3	1.8	3	2.7
Height ling B mm	1.8	3	1.8	3	2.7
Vert. height mm	7	8	7	8	8.5
Order no.	25053	25054	25055	25056	25057

TiDesign™ Profile 4.5/5.0

Titanium
Includes Abutment Screw Design
4.5/5.0 - M2, REF 24209 (Titanium)

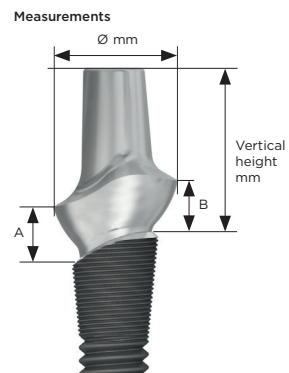

Short facts

Pre-designed for quick and easy adjustment.
Recommended torque -25 Ncm.

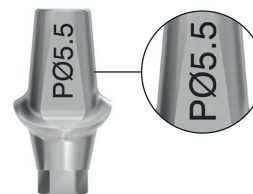

Marked with "P" to identify Profile abutment.
Marked with digits to identify diameter (Ø).

Atlantis® abutments

If you are not familiar with Atlantis abutments, please contact your laboratory and/or your local representative.
For more information visit www.atlantisabutment.com.

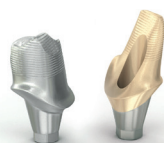

Index

Order by reference number

REF		page
24209	Abutment Screw Design 4.5/5.0 - M2	21
24858	Lab Abutment Screw Design	20
24966	Implant Guide Pin 4.5/5.0 - Short	20
24967	Implant Guide Pin 4.5/5.0 - Long	20
25029	OsseoSpeed® TX Profile 4.5 - 9 mm	18
25030	OsseoSpeed® TX Profile 4.5 - 11 mm	18
25031	OsseoSpeed® TX Profile 4.5 - 13 mm	18
25032	OsseoSpeed® TX Profile 4.5 - 15 mm	18
25033	OsseoSpeed® TX Profile 4.5 - 17 mm	18
25034	OsseoSpeed® TX Profile 5.0 - 9 mm	18
25035	OsseoSpeed® TX Profile 5.0 - 11 mm	18
25036	OsseoSpeed® TX Profile 5.0 - 13 mm	18
25037	OsseoSpeed® TX Profile 5.0 - 15 mm	18
25038	OsseoSpeed® TX Profile 5.0 - 17 mm	18
25039	OsseoSpeed® TX Profile 5.0 S - 9 mm	18
25040	OsseoSpeed® TX Profile 5.0 S - 11 mm	18
25041	OsseoSpeed® TX Profile 5.0 S - 13 mm	18
25042	OsseoSpeed® TX Profile 5.0 S - 15 mm	18
25043	OsseoSpeed® TX Profile 5.0 S - 17 mm	18
25044	Cover Screw Profile, Ø 3.8	19
25045	Healing Abutment Profile, Ø 6.0, 2 mm	19
25046	Healing Abutment Profile, Ø 6.0, 4 mm	19
25047	Implant Replica Profile	20
24986	Implant Pick-up Profile - Short	20
24985	Implant Pick-up Profile - Long	20
25052	Temporary Abutment Profile	19
25053	TiDesign™ Profile 4.5/5.0 - Ø 5.5, 1.8 mm	21
25054	TiDesign™ Profile 4.5/5.0 - Ø 5.5, 3.0 mm	21
25055	TiDesign™ Profile 4.5/5.0 - Ø 6.5, 1.8 mm	21
25056	TiDesign™ Profile 4.5/5.0 - Ø 6.5, 3.0 mm	21
25057	TiDesign™ Profile 4.5/5.0 - Ø 6.2, 2.7 mm, 15°	21
25058	Implant Driver Profile, 32 mm - Long	18
25059	Implant Driver Profile, 24 mm - Short	18
25062	Radiographic Implant Guides Profile	18

Alphabetical order

REF		page
24209	Abutment Screw Design 4.5/5.0 - M2	21
25044	Cover Screw Profile, Ø 3.8	19
25045	Healing Abutment Profile, Ø 6.0, 2 mm	19
25046	Healing Abutment Profile, Ø 6.0, 4 mm	19
25058	Implant Driver Profile, 32 mm - Long	18
25059	Implant Driver Profile, 24 mm - Short	18
24966	Implant Guide Pin 4.5/5.0 - Short	20
24967	Implant Guide Pin 4.5/5.0 - Long	20
24986	Implant Pick-up Profile - Short	20
24985	Implant Pick-up Profile - Long	20
25047	Implant Replica Profile	20
24858	Lab Abutment Screw Design	20
25029	OsseoSpeed® TX Profile 4.5 - 9 mm	18
25030	OsseoSpeed® TX Profile 4.5 - 11 mm	18
25031	OsseoSpeed® TX Profile 4.5 - 13 mm	18
25032	OsseoSpeed® TX Profile 4.5 - 15 mm	18
25033	OsseoSpeed® TX Profile 4.5 - 17 mm	18
25034	OsseoSpeed® TX Profile 5.0 - 9 mm	18
25035	OsseoSpeed® TX Profile 5.0 - 11 mm	18
25036	OsseoSpeed® TX Profile 5.0 - 13 mm	18
25037	OsseoSpeed® TX Profile 5.0 - 15 mm	18
25038	OsseoSpeed® TX Profile 5.0 - 17 mm	18
25039	OsseoSpeed® TX Profile 5.0 S - 9 mm	18
25040	OsseoSpeed® TX Profile 5.0 S - 11 mm	18
25041	OsseoSpeed® TX Profile 5.0 S - 13 mm	18
25042	OsseoSpeed® TX Profile 5.0 S - 15 mm	18
25043	OsseoSpeed® TX Profile 5.0 S - 17 mm	18
25062	Radiographic Implant Guides Profile	18
25052	Temporary Abutment Profile	19
25053	TiDesign™ Profile 4.5/5.0 - Ø 5.5, 1.8 mm	21
25054	TiDesign™ Profile 4.5/5.0 - Ø 5.5, 3.0 mm	21
25055	TiDesign™ Profile 4.5/5.0 - Ø 6.5, 1.8 mm	21
25056	TiDesign™ Profile 4.5/5.0 - Ø 6.5, 3.0 mm	21
25057	TiDesign™ Profile 4.5/5.0 - Ø 6.2, 2.7 mm, 15°	21

If you are not familiar with Atlantis abutments, please contact your laboratory and/or your local representative. For more information visit www.atlantisabutment.com.

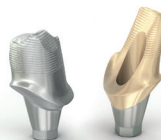

About Dentsply Sirona Implants

Dentsply Sirona Implants offers comprehensive solutions for all phases of implant therapy, including Ankylos®, Astra Tech Implant System® and Xive® implant lines, digital technologies, such as Atlantis® patient-specific solutions and Simplant® guided surgery, Symbios® regenerative solutions, and professional and business development programs, such as STEPPS™. Dentsply Sirona Implants creates value for dental professionals and allows for predictable and lasting implant treatment outcomes, resulting in enhanced quality of life for patients.

About Dentsply Sirona

Dentsply Sirona is the world's largest manufacturer of professional dental products and technologies, with a 130-year history of innovation and service to the dental industry and patients worldwide. Dentsply Sirona develops, manufactures, and markets a comprehensive solutions offering including dental and oral health products as well as other consumable medical devices under a strong portfolio of world class brands. As The Dental Solutions Company™, Dentsply Sirona's products provide innovative, high-quality and effective solutions to advance patient care and deliver better, safer and faster dentistry. Dentsply Sirona's global headquarters is located in York, Pennsylvania, and the international headquarters is based in Salzburg, Austria. The company's shares are listed in the United States on NASDAQ under the symbol XRAY.

Visit www.dentsplysirona.com for more information about Dentsply Sirona and its products.

THE DENTAL
SOLUTIONS
COMPANY™

