



mis[®] | SEVEN[®]

USER MANUAL 2019

MIS[®] SEVEN[®]

MIS believes in continuously developing innovative products, designed to improve and enhance implant dentistry and make it effective, safe and simple. In the spirit of these beliefs, and with the dedicated work of the research and development team and state-of-the art facilities, MIS is able to offer a range of innovative implants and surface treatments.



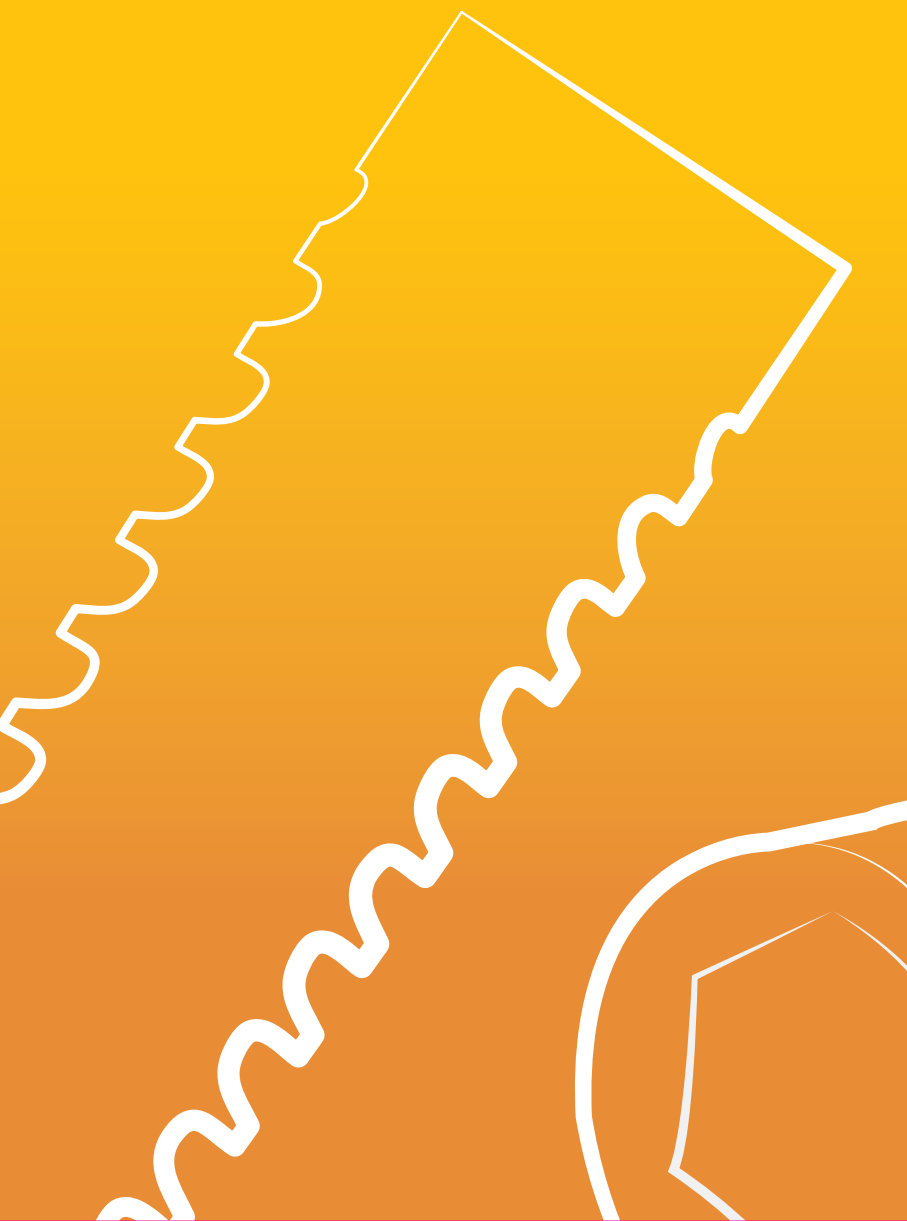

MIS® | Quality System

Complies with International Quality Standards: ISO
13485:2016 - Quality Management System for Medical
Devices and Medical Device Directive 93/42/EEC.



MIS reserves the right to modify the products described in this manual as well as to revise this publication at any time and without informing any person of such revision or change. All rights reserved. No part of this publication may be reproduced, transcribed, stored in an electronic retrieval system, translated to any language or computer language, or transmitted in any form whatsoever without the prior written consent of the publisher. Questions, comments or requests will be addressed promptly by contacting MIS specialists directly through our e-mailing address: service@mis-implants.com. The MIS website may be accessed at www.mis-implants.com. This online site highlights current products and reflects all new discoveries and developments. Warning: Only a licensed dentist should use these products. Note: This user manual is for educational purposes only.



OVERVIEW

- 08 Introduction
- 09 Raw Material
- 12 Manufacturing Process
- 14 Implant Surface

OVERVIEW

INTRODUCTION

MIS is a dynamic, state-of-the-art production company, developing and manufacturing a comprehensive range of dental implants designed to provide long-lasting, successful solutions to partial and complete edentulous conditions. MIS implant systems combine several advantageous elements such as choice of raw materials, macro-structure, micro-structure and surface treatments, in order to achieve high primary stability and successful osseointegration.

MIS upholds high quality standards by conducting comprehensive quality assurance evaluations throughout the entire production process. The unique MIS implant surface treatment combines sand-blasting and acid-etching to increase surface area, creating both micro and nano-structures and eliminating surface contaminants. The implant surface is continuously monitored by a comprehensive series of tests, conducted both in-house and by internationally recognized research institutes.

Tests include:

- Mechanical tests
- Fatigue test
- Insertion torque test
- Fracture test
- Seal test
- Surface analysis
- XPS analysis
- Roughness analysis
- SEM evaluations
- Bio-compatibility tests
- Cytotoxicity tests
- Sterility tests
- Removal torque values
- Histology
- Packaging integrity test

OVERVIEW
RAW MATERIAL

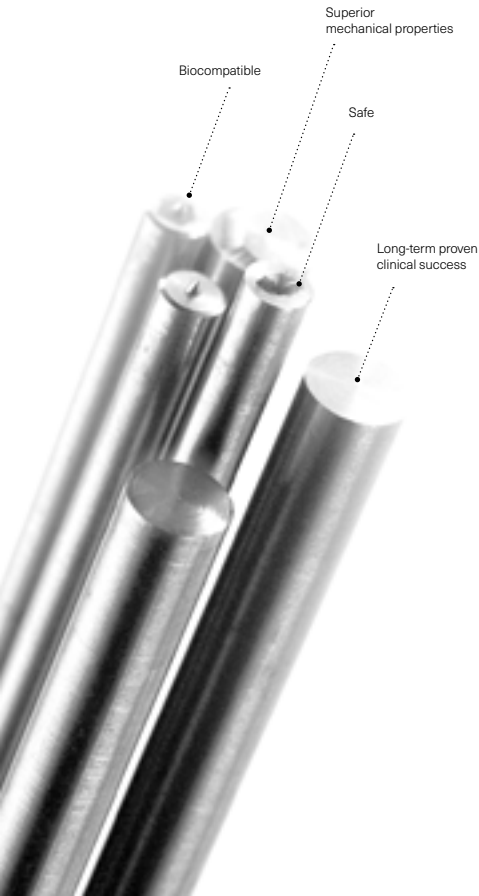

All MIS implants are made from Ti-6Al-4V ELI (Grade 23), the higher purity version of Ti-6Al-4V. This specific type of alloy combines biocompatibility, excellent fatigue strength and low elastic modulus. These benefits make Ti-6Al-4V ELI mechanically superior to titanium grade 4 and the ultimate dental and medical titanium grade.

Similar to commercially pure titanium (Grades 1-4), the outer surface of all MIS implants is comprised of a thin layer of pure titanium dioxide (TiO_2). In this way, bone cells cannot differentiate between the different titanium grades. The TiO_2 layer also prevents metallic ions leaking from the alloy, for safe, long-term use.

SS

OVERVIEW

RAW MATERIAL



Durability to fracture

Tensile strength min



Durability to Deformation

Yield strength min (N/mm²)



Shock Absorbency

Modulus of elasticity (1000X N/mm²)



N/mm²

1000 N/mm²

Ti-6Al-4V-ELI

Ti-Grade 4

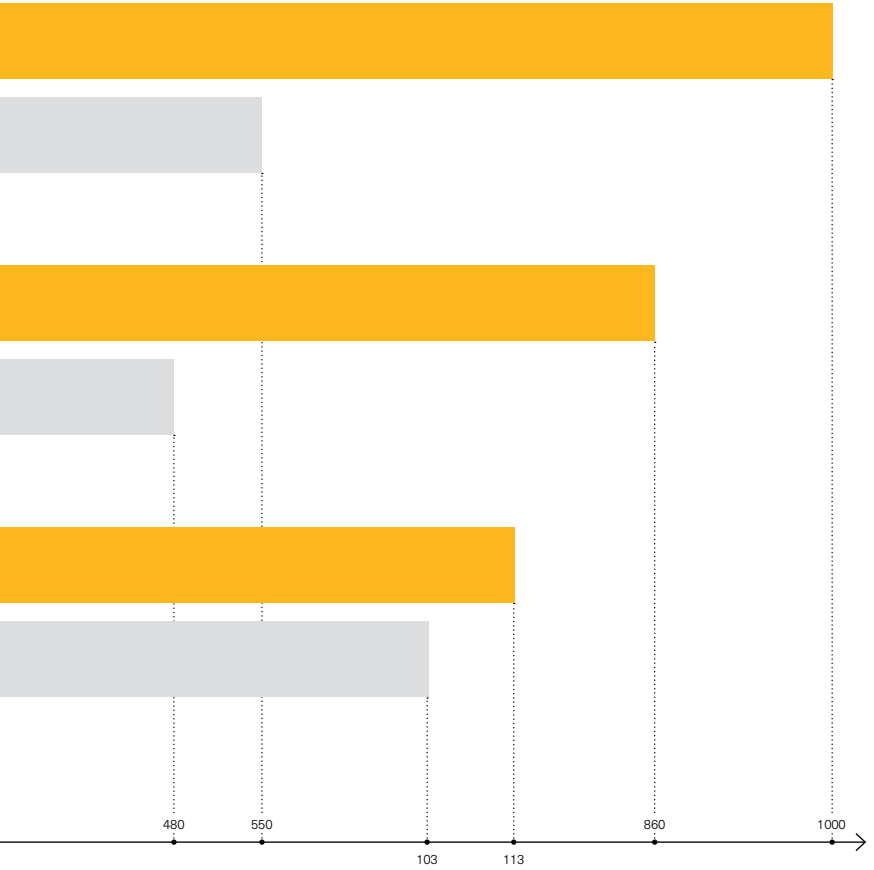

OVERVIEW
MANUFACTURING
PROCESS

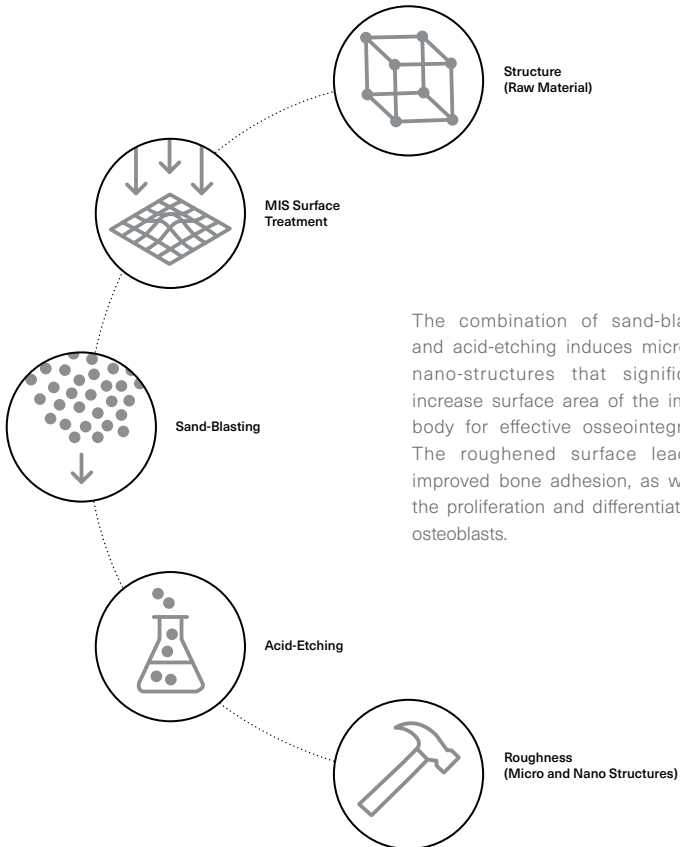

The combination of sand-blasting and acid-etching induces micro and nano-structures that significantly increase surface area of the implant body for effective osseointegration. The roughened surface leads to improved bone adhesion, as well as the proliferation and differentiation of osteoblasts.

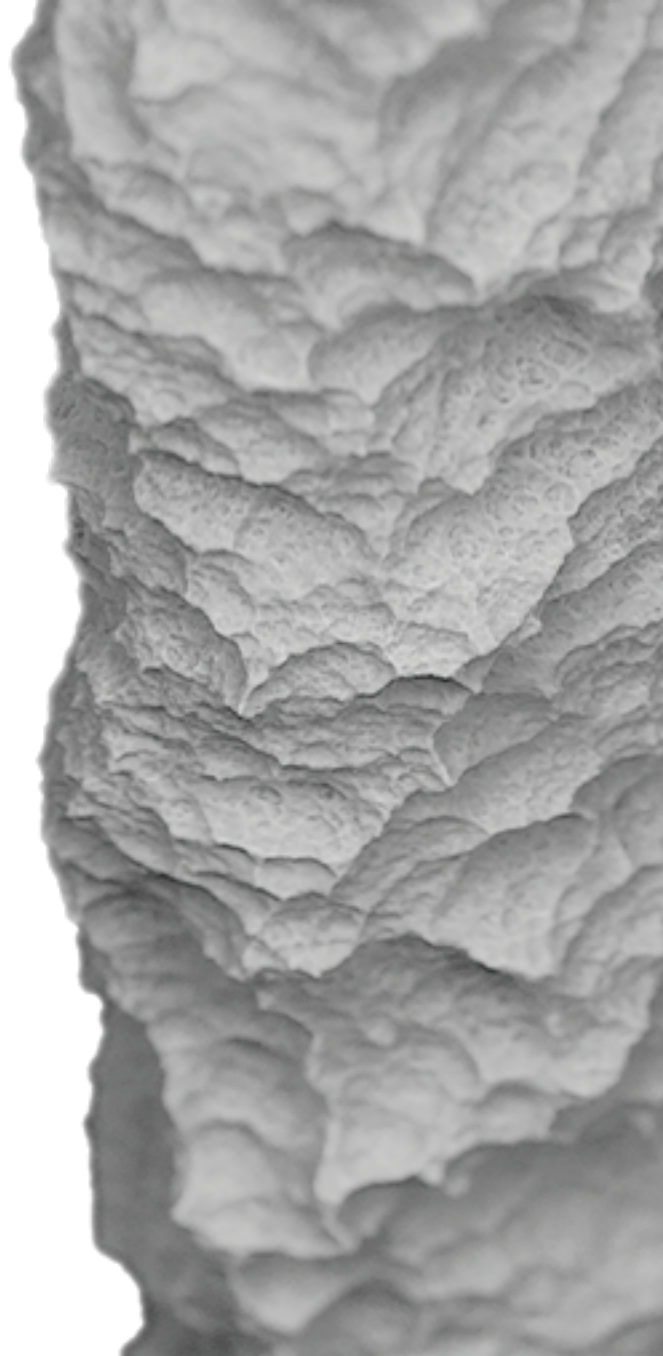

OVERVIEW

IMPLANT SURFACE

Osseointegration is defined as the attachment of bone to dental implants, and is the critical factor related to the long-term success of dental implants. Osseointegration is determined by the raw material of the implant, morphology and surface chemical composition.

Macro-Structure

The geometric design of the body and thread profile of the implant were designed to increase primary stability and to distribute forces from the implant to the surrounding bone.

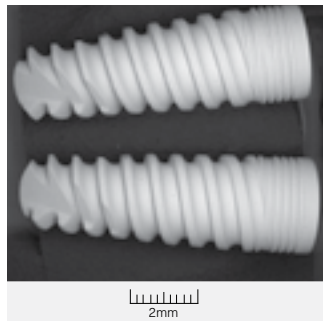

SEM image of two SEVEN* implants

Micro and Nano-Structure

All MIS implants are sand-blasted and acid-etched. This surface treatment increases the implant surface area, creating both micro and nano-structures, while eliminating various surface contaminants.

MIS is one of only a handful of companies worldwide using cutting-edge technologies on a daily basis for implant surface quality and roughness inspection.

Sand-blasted and acid-etched surfaces have been substantially proven to maximize the BIC (Bone-to-Implant Contact), achieving immediate and long-lasting osseointegration.

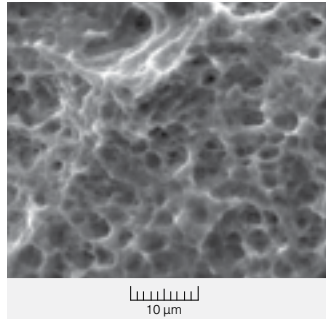

SEM image of the implant surface showing the nano-structure

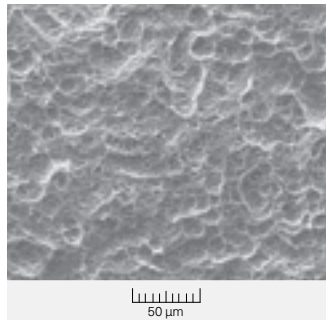

SEM image of the implant surface showing the micro-structure

Surface Composition

The outer surface of MIS implants, consist of a thin layer of pure titanium dioxide (TiO_2). Acid-etching and packaging processes are performed in a controlled environment clean-room to ensure purity and quality. Implants are inspected by electron microscope (SEM) scan and X-ray photoelectron spectroscopy (XPS), to ensure implants are free of contaminants.

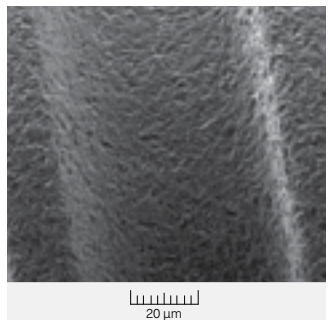

SEM image of the implant surface

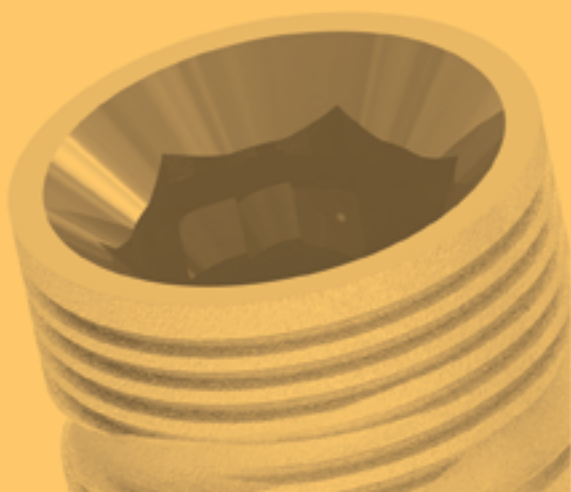

IMPLANTS

- 18 Introduction
- 19 Fixture - Technical Info
- 21 Features
- 22 Implant Range
- 23 Procedures

MIS | SEVEN®

INTRODUCTION

MIS self-tapping SEVEN® implants are specially designed for use in a wide range of bone types and placement protocols. Their geometric design includes dual threads, spiral channels stemming from the apex, micro-rings on the implant neck and a variable thread thickness along the implant. All MIS SEVEN® implants are supplied with a single use final drill, to ensure a sterile and consistently sharp blade for cutting bone walls to support the implant.



NARROW
PLATFORM

FIXTURE-
TECHNICAL INFO

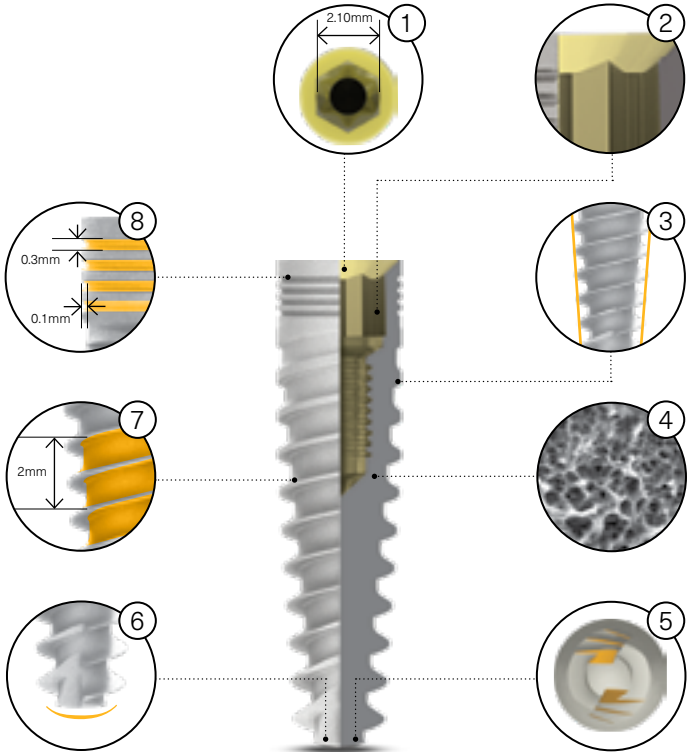

① Narrow: 2.10mm int. hex. connection

② Yellow anodize

③ Conical body

④ Surface - sand-blasted and acid-etched

⑤ Three spiral channels

⑥ Domed apex

⑦ Narrow: Dual thread 2mm

⑧ Micro-rings (0.1x0.3mm)

SS

STANDARD/
WIDE PLATFORM
FIXTURE-
TECHNICAL INFO

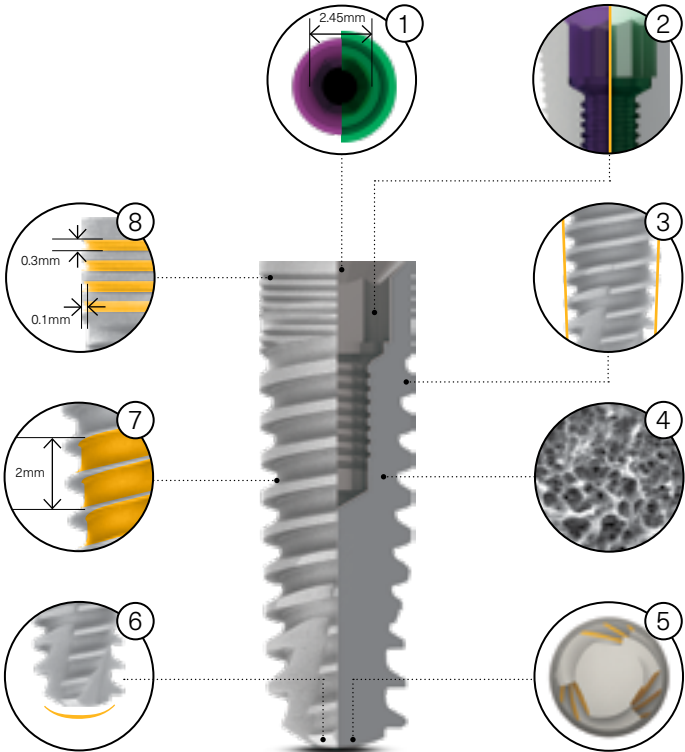

① Standard / Wide: 2.45mm int. hex. connection

② Standard purple anodize /Wide green anodize

③ Conical body

④ Surface - sand-blasted + acid-etched

⑤ Three spiral channels

⑥ Domed apex

⑦ Standard / Wide: Dual thread 2mm

⑧ Micro-rings (0.1x0.3mm)

MIS | SEVEN[®]

FEATURES

Features

- The SEVEN[®] implant is designed to suit a wide range of bone types and bone augmentation procedures.
- Specially designed final drill ensures shorter, safer drilling procedures.
- A double thread of 2mm increases implant insertion speed.
- Self-tapping capability.
- Three spiral channels for improved integration.
- The micro-rings (0.1x0.3mm) on the implant neck are designed to reduce stress in the crestal zone.
- Differential thread thickness (0.15-0.4mm) is designed to reduce bone compression.
- SEVEN[®] implants are available in 3.30, 3.75, 4.20, 5 and 6mm diameters and 6, 8, 10, 11.50, 13 and 16mm lengths.

Successful

The SEVEN[®] implant has a high success rate as a result of its advanced geometric design and well-established surface morphology.

Versatile

SEVEN[®] is designed for placement in a wide range of bone types and bone augmentation procedures.

Simple

Designed for a simpler and safer drilling procedure, every SEVEN[®] implant is packed with a sterile, single-use final drill.

Efficient

The large thread design and self-tapping capability enables secure and fast implant insertion.

Primary Stability

Tapered thread thickness and depth, locks implant into the surrounding bone, to ensure smooth insertion and mild bone compression, promoting high immediate stability.

Minimal Bone Resorption

The unique MIS surface treatment combined with micro-rings at the implant neck, are designed to facilitate minimal bone resorption.

MIS|SEVEN[®]

IMPLANT RANGE

SS

Platform	Narrow	Standard		Wide	
Length	Ø3.30mm	Ø3.75mm	Ø4.20mm	Ø5mm	Ø6mm
6mm			MF7-06420	MF7-06500	MF7-06600
8mm		MF7-08375	MF7-08420	MF7-08500	MF7-08600
10mm	MF7-10330	MF7-10375	MF7-10420	MF7-10500	MF7-10600
11.5mm	MF7-11330	MF7-11375	MF7-11420	MF7-11500	MF7-11600
13mm	MF7-13330	MF7-13375	MF7-13420	MF7-13500	MF7-13600
16mm	MF7-16330	MF7-16375	MF7-16420	MF7-16500	
18mm		MF7-18375	MF7-18420		
20mm		MF7-20375	MF7-20420		

Each SEVEN[®] implant is supplied with a cover screw and a final drill.

SS

Ø3.30mm/Ø3.75mm PROCEDURE

Drilling Speed (RPM)	1200-1500	900-1200		200-400	15-25
Diameter	Ø1.90	Ø2.40	Ø2.40	Ø2.20 Ø3.20	Ø3.30

Ø3.30

Final drill
for bone
types 1&2

Max. torque
60Ncm



Drilling Speed (RPM)	1200-1500	900-1200		500-700		200-400	200-500	15-25
Diameter	Ø1.90	Ø2.40	Ø2.40	Ø2.80	Ø2.80	Ø3.80 Ø3.60	Ø3.75	Ø3.75

Ø3.75

Final drill
for bone
types 1&2

or

MT-QDN33
countersink
for bone
types 3&4

Max. torque
60Ncm

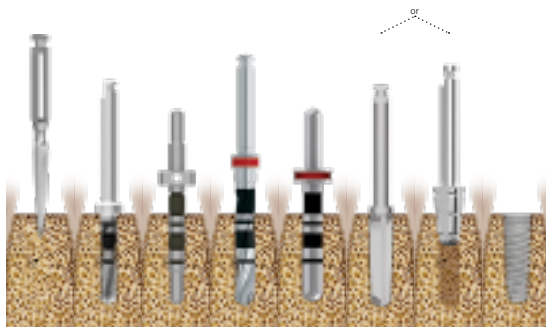

- Do not use the final drill for bone types 3&4.
- Recommended insertion torque: 35-60 Ncm.
- The drilling sequence is demonstrated using a 13mm implant.

- Procedure recommended by MIS cannot replace the judgment and professional experience of the surgeon.
- Drilling with the marking drill should stop upon penetration of the cortical bone.

SS

Ø4.20mm / Ø5mm PROCEDURES

Drilling Speed (RPM)	1200-1500	900-1200		500-700	400-700		200-400	200-500	15-25
Diameter	Ø1.90	Ø2.40	Ø2.40	Ø2.80	Ø3.20	Ø3.20	Ø3.30 Ø4.10	Ø4.20	Ø4.20

Ø4.20

Final drill for bone types 1&2
or
MT-GDN33 countersink for bone types 3&4
Max. torque 60Ncm

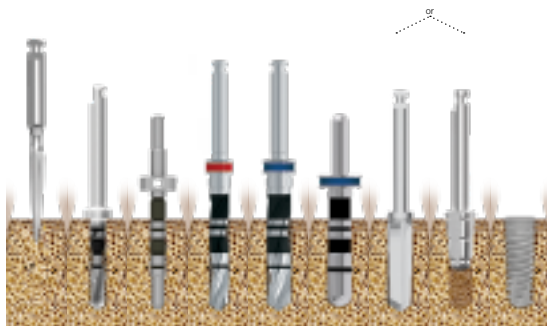

Drilling Speed (RPM)	1200-1500	900-1200		500-700	400-700	300-500		200-400	200-500	15-25
Diameter	Ø1.90	Ø2.40	Ø2.40	Ø2.80	Ø3.20	Ø4	Ø4	Ø4.10 Ø4.90	Ø5	Ø5

Ø5

Final drill for bone types 1&2
or
MT-GDN50 countersink for bone types 3&4
Max. torque 60Ncm



- Do not use the final drill for bone types 3&4.
- Recommended insertion torque: 35-60 Ncm.
- The drilling sequence is demonstrated using a 13mm implant.

- Procedure recommended by MIS cannot replace the judgment and professional experience of the surgeon.
- Drilling with the marking drill should stop upon penetration of the cortical bone.

SS

Ø6mm PROCEDURE

1200-1500	900-1200		500-700	400-700	300-500	300-500	300-500		200-400	200-500	15-25
Ø1.90	Ø2.40	Ø2.40	Ø2.80	Ø3.20	Ø4	Ø4.50	Ø5	Ø5	Ø5.10 Ø5.90	Ø6	Ø6

Ø6

Final drill for bone types 1&2
or
MT-GDN50 countersink for bone types 3&4
Max. torque 60Ncm



- Do not use the final drill for bone types 3&4.
- Recommended insertion torque: 35-60 Ncm.
- The drilling sequence is demonstrated using a 13mm implant.

- Procedure recommended by MIS cannot replace the judgment and professional experience of the surgeon.
- Drilling with the marking drill should stop upon penetration of the cortical bone.

MIS | SEVEN

MIS | SEVEN

Metric

Real Estate

01

02

03

04

05

06

07

08

09

10

11

12

13

14

15

16

17

18

19

20

21

22

23

24

25

26

27

28

29

30

31

32

33

34

35

36

37

38

39

40

41

42

43

44

45

46

47

48

49

50

51

52

53

54

55

56

57

58

59

60

61

62

63

64

65

66

67

68

69

70

71

72

73

74

75

76

77

78

79

80

81

82

83

84

85

86

87

88

89

90

91

92

93

94

95

96

97

98

99

100

101

102

103

104

105

106

107

108

109

110

111

112

113

114

115

116

117

118

119

120

121

122

123

124

125

126

127

128

129

130

131

132

133

134

135

136

137

138

139

140

141

142

143

144

145

146

147

148

149

150

151

152

153

154

155

156

157

158

159

160

161

162

163

164

165

166

167

168

169

170

171

172

173

174

175

176

177

178

179

180

181

182

183

184

185

186

187

188

189

190

191

192

193

194

195

196

197

198

199

200

201

202

203

204

205

206

207

208

209

210

211

212

213

214

215

216

217

218

219

220

221

222

223

224

225

226

227

228

229

230

231

232

233

234

235

236

237

238

239

240

241

242

243

244

245

246

247

248

249

250

251

252

253

254

255

256

257

258

259

260

261

262

263

264

265

266

267

268

269

270

271

272

273

274

275

276

277

278

279

280

281

282

283

284

285

286

287

288

289

290

291

292

293

294

295

296

297

298

299

300

301

302

303

304

305

306

307

308

309

310

311

312

313

314

315

316

317

318

319

320

321

322

323

324

325

SURGICAL PROCEDURES

- 28 Recommendations for Use
- 30 Step-by-Step Protocol

SURGICAL
PROCEDURES**RECOMMENDATIONS
FOR USE**

Adequate bone is needed to support the implant with width and height being the primary dimensions of concern. The amount of available bone should be evaluated based on accepted imaging and radiological techniques used in implant dentistry.

In addition, a very careful evaluation has to be made as to the location of vital blood vessels, nerves, maxillary sinus, soft tissue spaces, and their relation to the site planned for implant placement.

Contraindications

All contraindications associated with elective surgery should be considered. These include, but are not limited to:

- Metabolic bone diseases.
- Blood and clotting disorders.
- Medications affecting clotting or bone turnover.
- Significant vascular or anatomic factors at the implant site.
- Treatments, medications, or disorders that interfere with bone biology or wound healing.
- Hypersensitivity or known allergy to any components of the implants or their superstructures.

Other Contraindications

- Poor patient motivation.
- Psychiatric disorders that interfere with patient understanding and compliance with the necessary procedure.
- Unrealistic patient expectations.
- Unattainable prosthodontic reconstruction.
- Inability of patient to manage oral hygiene.





Risks

Risks associated with the surgical procedure fall into four broad categories:

1. Immediate anesthetic and surgical risks.
2. Psychological and psychiatric risks.
3. Medical threats to long-term retention.
4. Long-term deleterious effects of implants on health.

The risks may include:

- Inadvertent perforation of the nasal maxillary sinus, local and systemic infections, perforation into soft tissue spaces, rupture of primary blood vessels and nerve injury.
- Temporary conditions that might result from implant placement may include pain and swelling, speech difficulties and hemorrhage.
- Long term complications may include (but are not limited to) nerve injuries and persistent local or systemic infections. Special care and attention needs to be given to susceptible individuals with compromised immune systems due to medications, systemic conditions or those who have undergone body part replacements.

Important Warning: Practitioner's lack of adequate training, knowledge and experience are considered major risk factors to the patient's health and to the implant's success. Therefore, no implant placement procedure should be performed without prior training by a certified institution.

SURGICAL
PROCEDURES**STEP-BY-STEP
PROTOCOL**

The surgical manual is designed to provide an overview of the pre-surgical and the surgical procedures applicable to the internal hex connection implant range. Successful implant placement procedures are the result of a wide range of factors. This step-by-step protocol aims to ensure that significant factors are not overlooked.

**1****Patient Selection and Medical History (General medical history)**

Patients must be carefully assessed for their ability to safely undergo surgical procedures. Medical history should be evaluated to ensure that patients are not put at risk. Certain medical conditions are considered either absolute or relative contra-indications for surgery. These may relate (but not be limited) to the following conditions: Patients who are either taking or have taken medications for the treatment of osteoporosis; immunodeficiency

or immunosuppressive treatments; malignancies; head and neck radiation; poorly controlled diabetes or other hormonal disorders; bleeding disorders or anticoagulant therapy; recent myocardial infarction, severe cardiac insufficiency and valve pathology; general bone diseases; hypersensitivity or known allergy to specific relevant materials; psychiatric or personality disorders that limit or interfere with patients' understanding and compliance. Please be aware of the fact that updates based on current medical literature may include or exclude certain conditions.

②

Dental Conditions and Oral Hygiene

A complete and thorough intraoral examination must be performed and recorded. This must include an evaluation of the dentition, oral hygiene, smoking, habits, attitude to oral health, and any other relevant information. Implant procedures should not be performed on patients with active osteolytic conditions, active periodontal disease or infectious areas at the implant site. Extreme bruxing and clenching should be taken into consideration.

③

Radiographs and Imaging

Diagnosis and treatment planning for implant placement require the use of different types of radiographs and imaging technologies. Panoramic radiographs are considered standard pre-surgery radiographs. However, additional imaging modalities such

as CT (Computerized Tomography), tomography and periapical radiographs may be required.

It should be emphasized that certain countries require specific radiographs to be taken prior to, during and after surgery. It is the obligation of the surgeon to ensure that all required documentation is available and recorded before and after surgery. Vertical and horizontal dimensions of implant sites should be measured and charted. The anatomical relationships of neighboring teeth and proximity to anatomical structures such as the mandibular canal, maxillary sinus and base of the nose must be evaluated. Bone inclination and shape should also be taken into account. Surgical guides with radiopaque markers are recommended. These, coupled with computerized tomographic radiographs can later be altered to be used as computer-based surgical guides.



④

Treatment Plan (Patient cooperation)

Based on patient needs, alternative treatment plans should be considered and discussed. The chosen treatment plan should result in a sequence of actions related to initial preparations, surgical phase and a restorative phase.

⑤

Implant Selection

SEVEN® implants feature a range of diameters and lengths. It is recommended that wide platform implants are used in the premolar and molar areas, while standard platform implants are used in the anterior areas. Specific analysis of available bone and distance from vital structures at each proposed site may lead to the choice of specific implant length and diameter.

However, current augmentation procedures may allow the use of longer or wider implants.

⑥

Surgical Phase

Surgery should be performed under strict infection control conditions. Preoperative medications and/or antibiotics may be required based on the patient's condition and the extent of surgery, and should be decided upon by the operating surgeon. Other monitoring measures, including blood-pressure and pulse measurements should also be considered. Emergency resuscitation apparatus should be available. Each MIS implant comes with labels including all relevant data related to the implant. It is critical that the label is kept as part of the patient's record for future reference.



⑦

Osseointegration Phase

Current literature supports multiple loading options. Dentist should decide when to load implants based on specific parameters, related to their individual case.

⑧

Restorative Phase

SEVEN® implants can support different types of final restorations. Following the solution specified in the treatment plan, the final restoration is fabricated based on accepted restorative protocols. Special attention should be paid to ensure correct occlusal adjustment, in order to prevent overloads on the implant supported restorations. MIS superstructures and components must be used with all MIS implants.

⑨

Follow-up

Annual follow-up evaluations including radiographs are required. Special emphasis should be put on oral hygiene and habits, occlusion adjustments and the stability of the prosthesis.

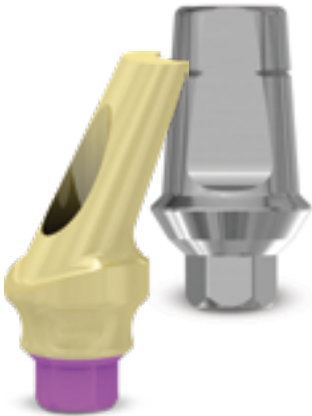

WARNINGS: SEVEN® implants are supplied in a sealed and sterilized package. Implants should never be reused, and implants whose sterility is compromised should not be used. Implants should not be used later than the specific expiration date printed on the package. Implant placement should be performed in accordance with acceptable placement and loading protocols. Recommended MIS procedures are described on pages 18-43. However, it should be emphasized that procedures recommended by MIS cannot replace the judgment and professional experience of the surgeon. The sale of MIS implants is restricted by law to licensed dentists only. Implant placement procedures should only be performed by trained and licensed dentists. Initial planning is of the utmost importance. As this is a prosthetic driven procedure, it is advisable that restorative dentists be involved at the planning and surgical phases as active participants when making decisions affecting the choice of implant type and the three dimensional positioning of the implant.



SURGICAL KIT

36 Surgical Kit Description

38 Kit Contents

THE SURGICAL KIT DESCRIPTION

The SEVEN® surgical kit comprises a complete range of drills and tools required for SEVEN® implant placement procedures. It features a convenient ergonomic layout that follows the surgical drilling sequence, and includes a set of length-based pilot drills for a smoother, more accurate procedure. Kit components are color-coded for immediate identification of diameters for both implants and restorative platforms.



Warning! Avoid damage! The sterilization kit-box and insert must be cleaned and sterilized before each use. Please see sterilization instructions on page 58. Store the kit in a dark and dry place until use.



▶
MK-T048







Advanced surgical kit for SEVEN® implant system with external irrigation drills

THE SURGICAL KIT KIT CONTENTS





Marking Drills

- ①  MT-SMD10
- ②  MT-TDN19

Marking Drills





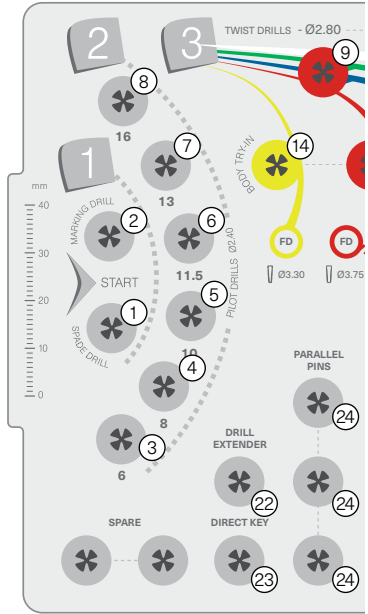

- ③  CT-P2406
- ④  CT-P2408
- ⑤  CT-P2410
- ⑥  CT-P2411
- ⑦  CT-P2413
- ⑧  CT-P2416

Twist Drills

- ⑨  MT-TDT28
- ⑩  MT-TDT32
- ⑪  MT-TDT40
- ⑫  MT-TDT45
- ⑬  MT-TDT50



Body Try-Ins

- ⑭  CT-BTC24
- ⑮  MT-BTT28
- ⑯  MT-BTT32
- ⑰  MT-BTT40
- ⑱  MT-BTT45
- ⑲  MT-BTT50

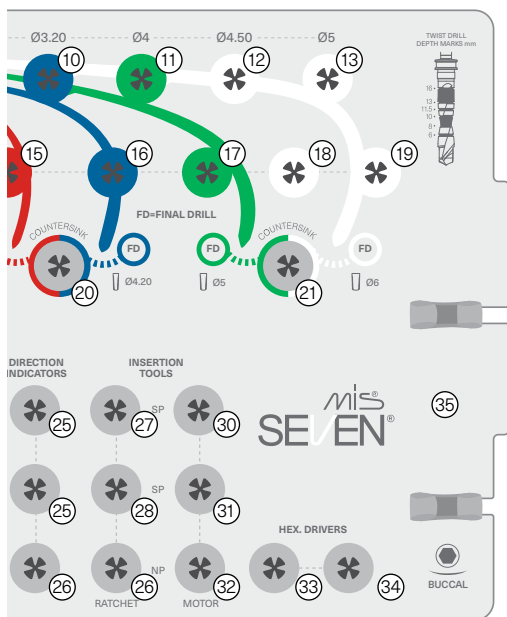

Countersinks



Insertion Tools

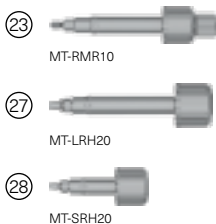

MK-EI48

With external irrigation drills

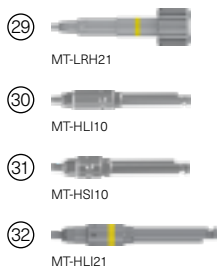

Surgical Tools

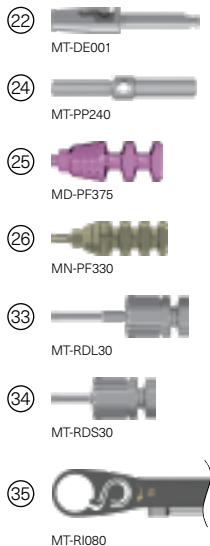













SS

THE SURGICAL KIT KIT CONTENTS











The SEVEN® Surgical Kit contains tools specifically designed for a step-by-step placement process. Correct preparation of the implant site ensures efficient and accurate placement and high primary stability.















	Cat. No.	Description	Dimensions	Material
	CT-P2406	Pilot drill with built-in stopper Ø2.4/2.0	Length 28mm Height 6mm	Stainless steel
	CT-P2408	Pilot drill with built-in stopper Ø2.4/2.0	Length 28mm Height 8mm	Stainless steel
	CT-P2410	Pilot drill with built-in stopper Ø2.4/2.0	Length 28mm Height 10mm	Stainless steel
	CT-P2411	Pilot drill with built-in stopper Ø2.4/2.0	Length 28mm Height 11.5mm	Stainless steel
	CT-P2413	Pilot drill with built-in stopper Ø2.4/2.0	Length 33mm Height 13mm	Stainless steel
	CT-P2416	Pilot drill Ø2.4/2.0	Length 37.5mm Height 16mm	Stainless steel
	CT-BTC24	Body try-in 2.40mm for tapered impl. procedure	Ø2.40mm Length 28.5mm	Titanium
	MT-BTT28	Body try-in Ø2.80mm for tapered impl. procedure	Ø2.80mm Length 28.5mm	Titanium
	MT-BTT32	Body try-in Ø3.20mm for tapered impl. procedure	Ø3.20mm Length 28.5mm	Titanium
	MT-BTT40	Body try-in Ø4mm for tapered impl. procedure	Ø4mm Length 28.5mm	Titanium
	MT-BTT45	Body try-in Ø4.50mm for tapered impl. procedure	Ø4.50mm Length 28.5mm	Titanium
	MT-BTT50	Body try-in Ø5mm for tapered impl. procedure	Ø5mm Length 28.5mm	Titanium

SS

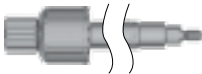
THE SURGICAL KIT KIT CONTENTS

	Cat. No.	Description	Dimensions	Material
	MT-TDT28	Twist drill 2.80mm external irrigation	Ø2.80mm Length 37.5mm	Stainless steel
	MT-TDT32	Twist drill 3.20mm external irrigation	Ø3.20mm Length 37.5mm	Stainless steel
	MT-TDT40	Twist drill 4mm external irrigation	Ø4mm Length 38.2mm	Stainless steel
	MT-TDT45	Twist drill 4.50mm external irrigation	Ø4.50mm Length 38.2mm	Stainless steel
	MT-TDT50	Twist drill 5mm external irrigation	Ø5mm Length 38.2mm	Stainless steel
	MT-SMD10	Spade marking drill	Length 27.5mm	Stainless steel
	MT-TDN19	Marking drill Ø1.90mm external irrigation	Ø1.90mm Length 34mm	Stainless steel
	MT-LRH20	Long insertion tool for int. hex. connection	Length 32.3mm	Stainless steel
	MT-LRH21	Long insertion tool for int. hex. connection, NP	Length 31.6mm	Stainless steel
	MT-RDS30	Short hex. drive 0.05 inch	Length 18.5mm	Stainless steel
	MT-RDL30	Long hex. drive 0.05 inch	Length 23.5mm	Stainless steel

	Cat. No.	Description	Dimensions	Material
	MT-DE001	Drill extender	Length 24mm	Stainless steel
	MT-PP240	Parallel pin Ø2.40mm for tapered impl. procedure	Ø2.40/ Ø3mm / Length 24mm	Stainless steel
	MN-PF330	Direct press fit for closed tray NP	Length 16.7mm	Titanium
	MD-PF375	Direct press fit for closed tray	Length 16.3mm	Titanium
	MT-HS110	Short insertion tool, int. hex. connection	Length 24.4mm	Stainless steel
	MT-HL110	Long insertion tool, int. hex. connection	Length 28.2mm	Stainless steel
	MT-HL121	Implant motor insertion tool, long, int. hex., NP	Length 27.5mm	Stainless steel
	MT-SRH20	Short insertion tool for int. hex. connection	Length 22.30mm	Stainless steel
	MT-RMR10	Long direct hand and ratchet key	Length 38.50mm	Stainless steel
	MT-GDN33	Countersink for standard platform implant system	Ø3.75mm/ Ø4.20mm Length 26mm	Stainless steel
	MT-GDN50	Countersink for wide platform implant system	Ø5.00mm/ Ø6.00mm Length 26mm	Stainless steel
	MT-RT080	Torque wrench for implantation assembly	Length 95mm	Titanium



DRILLS

- 46 Using MIS Drills
- 47 Drill Stoppers
- 48 Color Code
- 50 Recommendations for Use
- 52 Overview
- 54 Final Drills
- 56 Countersink Drills
- 58 Drill Maintenance

DRILLS

USING MIS DRILLS

Implant placement procedures require the use of several drills with different diameters and characteristics. MIS offers drills with external irrigation, as well as conical and ceramic drills. Most MIS drills are marked for depth control and are color-coded for immediate identification of drill diameter.

Features

MIS drills are designed to be used with all MIS implants. Short drills are also available for each diameter. All drills are color-coded. The drills are marked for depths of 6, 8, 10, 11.5, 13 and 16mm, and are equipped with a podium that allows the connection of MIS drill stoppers. All MIS drills have a 120° cutting degree. The sharpness and high quality of the drills allow for up to 30 uses. Careful use of sharp drills will ensure atraumatic drilling procedures, and minimal heat generation.

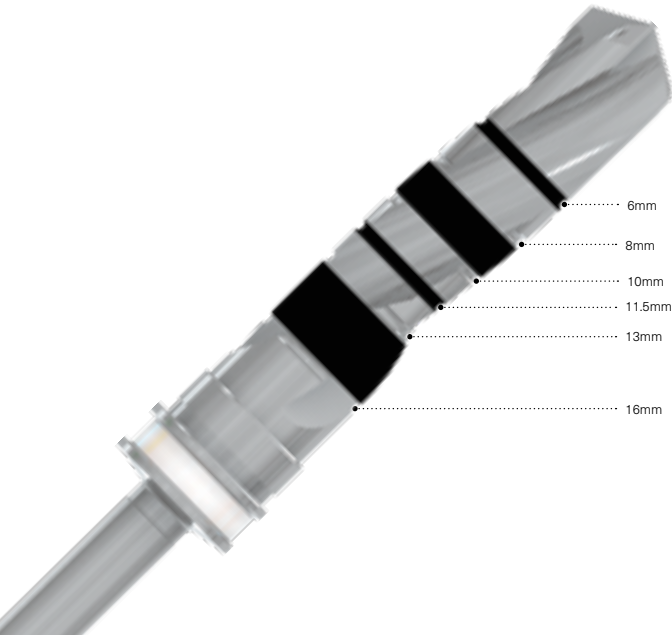

DRILLS

DRILL STOPPERS

MIS offers drill stoppers to enable simple and accurate depth control.

The SEVEN® drill stopper kits (MK-SDS06, MK-SDS08, MK-SDS10, MK-SDS11, MK-SDS13) are a series of kits, each used for one specific implant length: 6, 8, 10, 11.5 or 13mm.

For most commonly used implant lengths, 3.75 or 4.2, MIS offers a single assorted kit - the SEVEN® standard platform (MK-BS001) drill stoppers kit, which includes all stoppers required for safe placement of standard platform implants.



**SEVEN® Depth-Based
Drill Stoppers Kits**

(MK-SDS06, MK-SDS08, MK-SDS10,
MK-SDS11, MK-SDS13)



**SEVEN® Drill Stoppers Kit
Standard Platform**

(MK-BS001)



SS







DRILLS

COLOR CODE

Color-coding is used for easy identification of drills or implants diameters.





		Drill diameter	Implant
	CT-P2416	Ø2.40	Ø3.30
	MT-TDT28	Ø2.80	Ø3.75
	MT-TDT32	Ø3.20	Ø4.20
	MT-TDT40	Ø4	Ø5
	MT-TDT45	Ø4.50	Ø6
	MT-TDT50	Ø5	Ø6

DRILLS RECOMMENDATIONS FOR USE

Important!

Please note that the apical tip of all MIS twist drills is up to 0.5mm longer than the depth of the corresponding implant. This should be taken into account during the planning phase.

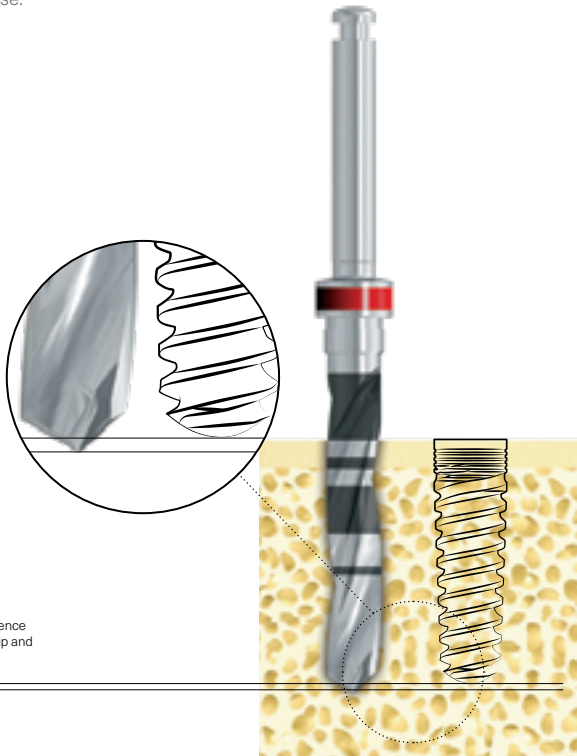

▶ Geometrical difference between the drill tip and the implant

Depth Verification

Depth verification may be made by the use of body try-in tools (MT-BTTxx). The laser markings correspond to those on the drills and allow a safe, easy way to ensure the required depth is achieved.

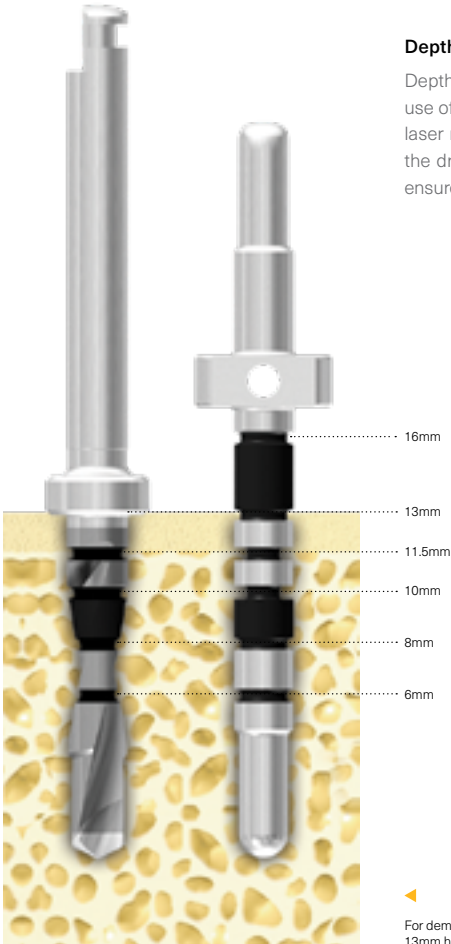

For demonstration purposes, the (CT-P2413) 13mm height drill with built-in stopper, is shown.

SS

DRILLS OVERVIEW



Type

**Spade
Drill**

**Marking
Drill**

Recommended
Speed

1200-1500 RPM

1200-1500 RPM

Length &
Diameter

The spade drill has a diameter of $\text{\O}1.9\text{mm}$ and a sharp tip. The spade drill is 27.5mm in length and made of stainless steel.

The marking drill supplied is 34mm in length and 1.90mm in diameter.

Aim of Use

The spade drill is used to mark a reference point for further drills. It is especially useful in immediate placement procedures.

The marking drill is used for creating a reference point in the center of the ridge and to mark the drilling location for further drilling.



Pilot Drill

900-1200 RPM

SEVEN® pilot drills come in six different lengths: 6, 8, 10, 11.5, 13 and 16mm and are equipped with a stopper to simplify the drilling procedure.

Pilot drills are the first invasive drills used for the preparation of a fixture site. The pilot drills are length specific to ensure precise drilling depth.



Twist Drill

400-700 RPM

Twist drills come in a variety of diameters and lengths.

Twist drills are used to widen the osteotomy. They are NOT length specific, and have laser markings for 6, 8, 10, 11.5, 13 and 16mm implants. The use of stoppers is highly recommended when using twist drills.

SS

SEVEN[®]
FINAL DRILLS

Final drill for implant diameters

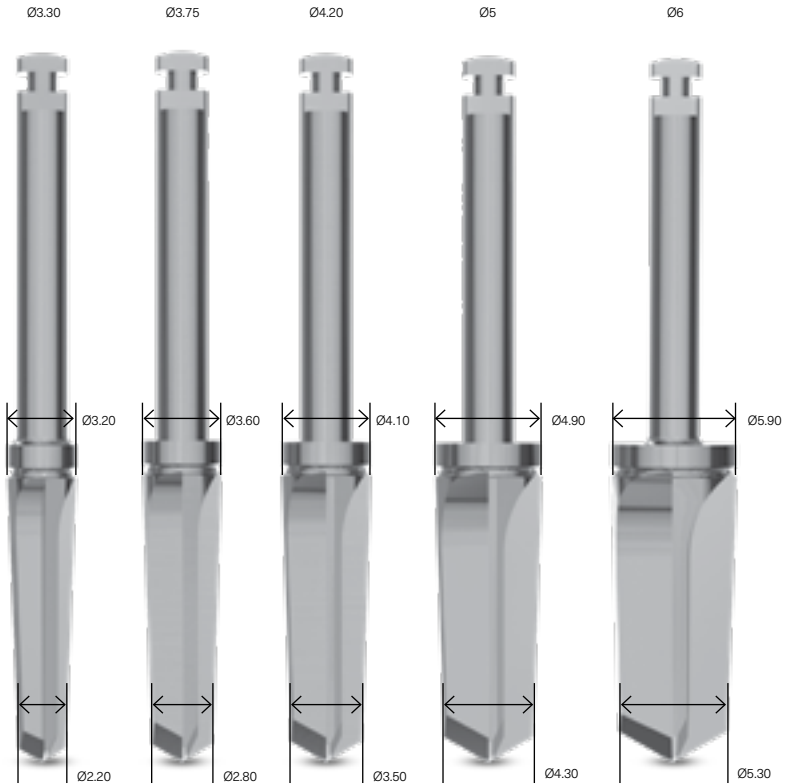

The specially designed single-use final drill is recommended for use in bone types 1 and 2 for 6, 8, 10, 11.50, 13 and 16mm SEVEN® implants in order to prevent pressure on the implant neck. The special final drill is supplied with every implant, allowing for a shorter, safer drilling procedure.

Recommended drilling speed is 200-400 Rpm.

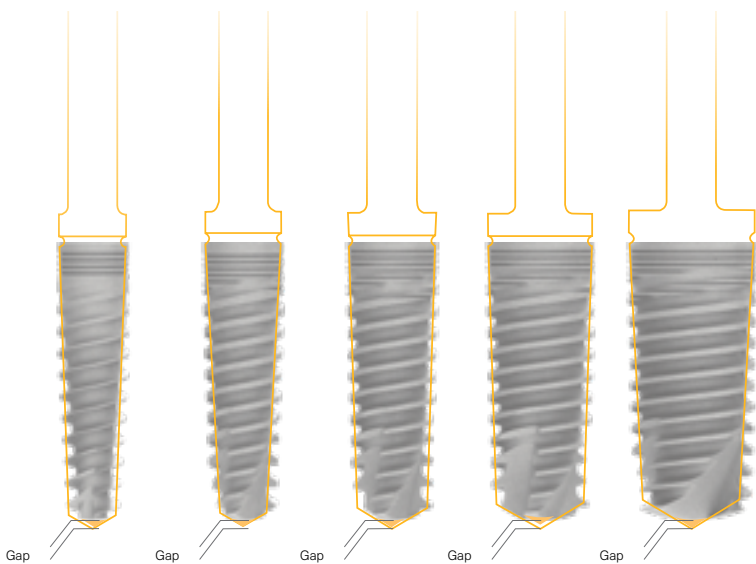

DRILLS
**COUNTERSINK
DRILLS**

MT-GDN33, MT-GDN50

A countersink drill is used to widen the entrance area of the osteotomy, to prevent extensive pressure on the implant neck.

Depth marks of 3.75 and 4.20mm appear on the standard platform countersink drill (MT-GDN33), and 5 and 6mm marks appear on the wide platform countersink drill (MT-GDN50). Recommended drilling speed is 200-500 RPM.

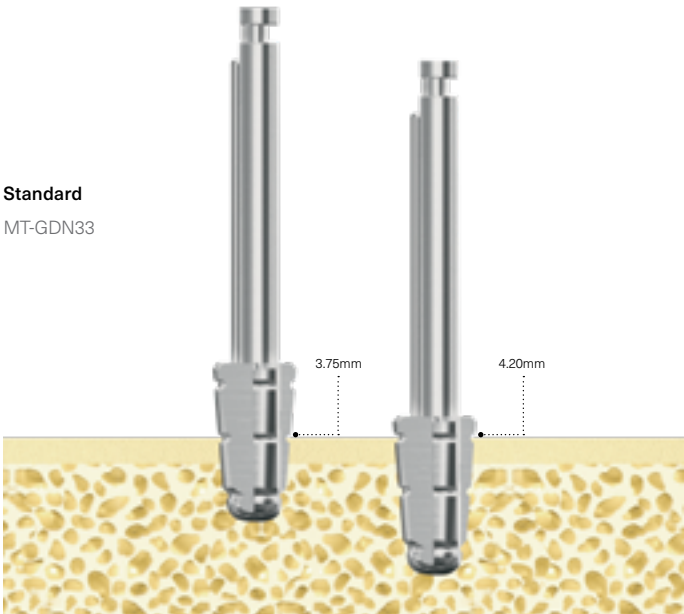
Standard
MT-GDN33

When drilling into hard bone, extra care should be exercised to prevent overheating. Therefore, it is recommended to use lower drilling speeds with higher torque. In addition, to prevent excessive pressure on the bone or the need for extremely high insertion torque, it is strongly recommended to use the appropriate countersink drills upon completion of the drilling procedure.

Wide
MT-GDN50

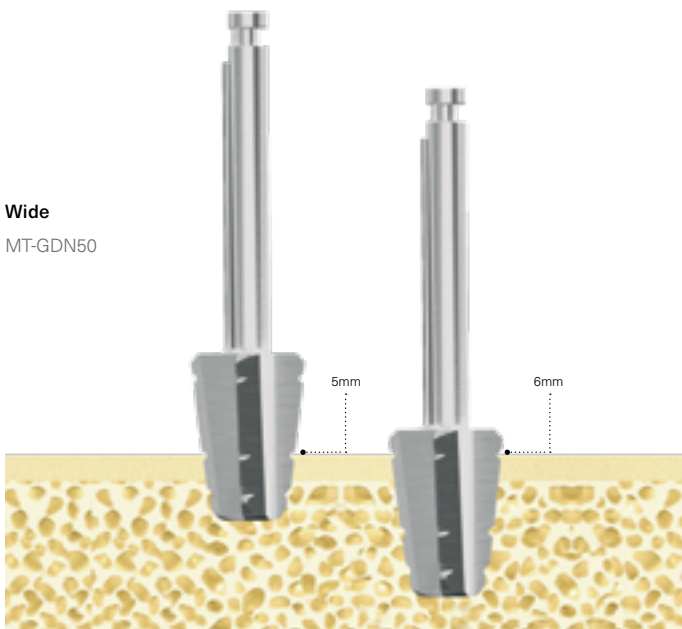

DRILLS

DRILL MAINTENANCE

Correct and careful maintenance of MIS drills is extremely important. Damage to drill tips can cause significant impairment of drill function. The following are detailed instructions for proper maintenance.



Cleaning and Sterilization Instructions

Attention

For your own safety, please wear personal protective equipment (gloves, glasses, mask).

Pre-Cleaning

- Soak the drills immediately after use in a detergent and disinfecting solution, preferably an enzymatic cleaning solution, with a pH level between 6-9, prepared with lukewarm water for 5 minutes.
- Scrub the drills under running water with soft nylon brush to remove any remaining blood or debris.
- Rinse under tap water (at least 1 min).
- Place the drills in a kit, support or rack to avoid any contact between them during the next cleaning procedure.

Cleaning Procedure Manual Cleaning

- Prepare an ultrasonic bath with a cleaning solution at a concentration and temperature specified in the detergent manufacturer's instructions.
- Immerse the drills completely and activate the bath for at least the recommended time in the detergent manufacturer's instructions.
- Rinse under tap water (at least 1 min).

Alternative Automated Cleaning

- Place the rack in a washer-disinfector and apply a cleaning procedure according to the manufacturer's recommendations.

Drying and Sterilization

- Dry on a single-use non-woven cloth, through a drying cycle of washer- disinfectors or with filtered compressed air.
- Inspect the drills and discard those with defects. Repeat cleaning if required.
- Place the drills in a kit, and pack in a sterilization pouch.
- Steam sterilize according to the table below. Do not exceed the recommended temperature specified.
- Keep the sterilization packaging in a dry and clean environment.

Cycle type	Pre-vacuum	Gravity displacement
Temperature	132°C/270°F	135°C/275°F
Exposure	4 min.	10 min.
Drying time	20 min.	30 min.



Recommendations

- Cutting tools should be used for a maximum of 30 uses.
- Distilled water should be used in order to prevent water spots.
- For all metal instruments, it is recommended to use anticorrosive disinfecting and cleaning agents. They should be free of: aldehyde, ethanolamine, chlorine and acid.
- Use only autoclaves that meet the requirements of EN 13060, EN 285.
- Use a validated sterilization procedure according to ISO 17665.
- For automated cleaning procedures, use a washer-disinfector approved according to EN ISO 15883.



SURGICAL & PROSTHETIC TOOLS

- 62 MIS Ratchets Range
- 64 Implant Site Depth Probe
- 65 Implant Direction Indicator
- 66 Implant Extraction Key
- 68 Specialized Prosthetic Tools
- 70 Friction Fit
- 72 SOS Broken Screw Kit
- 74 Maintenance

SS

SURGICAL &
PROSTHETIC TOOLS

MIS RATCHET RANGE

MIS offers a line of uniquely designed ratchets, to simplify both prosthetic screw tightening and implant insertion, allowing an accurate and safe performance. To prevent damage to the mechanism, it is critical that the ratchet is used only with keys and adapters that are specifically designed for it.

Three ratchet types, to allow an accurate and safe procedure:



MT-RT070

Surgical torque ratchet.
Controlled torque for implant
placement (35-75 Ncm).



MT-RI030

Monoblock ratchet



MT-RI040

Torque ratchet for prosthetic screws.
Controlled tightening torque for
prosthetic screws (10-30 Ncm).



Warnings

- MIS recommends the use of a torque controlled driver whenever possible.
- The ratchet wrench MT-RI030 may transfer torque levels that do not correlate to the recommendations specified for implant placement or screw fastening.
- Excess loads may result in damage to implants, components, screws, and even to the bone-to-implant interface.
- Please note that the recommended torque for implant placement is 35-60 Ncm.



Instrument Maintenance

- The device is delivered non-sterile.
- Cleaning and sterilization are required prior to use.



Cleaning and Sterilization

For cleaning and sterilization instructions please refer to page 74.

User Instructions



Store the ratchet on its own, not attached to any tools.



Clean thoroughly immediately after use.

SURGICAL TOOLS
**IMPLANT SITE
DEPTH PROBE**

MT-BT120

The probe enables quick and easy examination of a prepared implant site, for each step of the procedure. Marked depths: 6, 8, 10, 11.5, 13 and 16mm.

The depth probe includes an apical flat section to ensure accurate placement within the osteotomy. Dimensions: $\varnothing 2\text{mm}$, total length: 87mm.

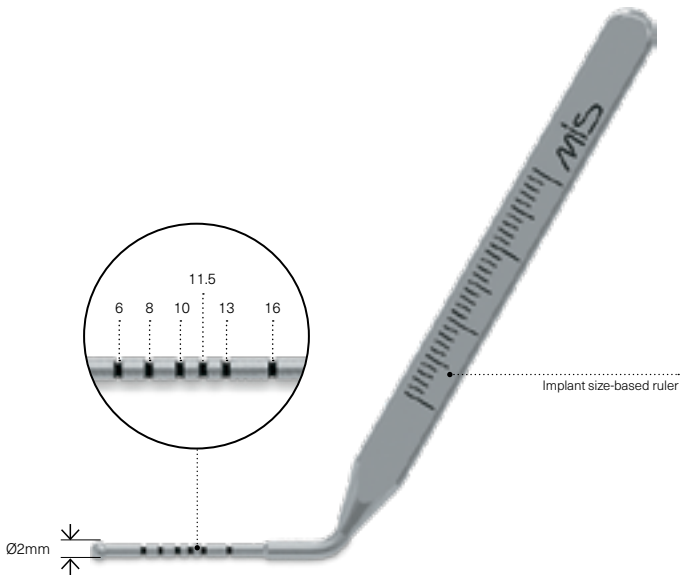

SS

SURGICAL TOOLS

IMPLANT DIRECTION INDICATOR

MD-PF375/ MN-PF330

The direction indicator is connected directly to the implant. This surgical instrument enables the visualization of the 3D position of a particular implant.

The indicator features groove marks indicating gingival heights (each groove mark indicates 1 mm of gingival height). The round cavities at the upper section of the tool represent the position of the anti-rotational index within the implant.

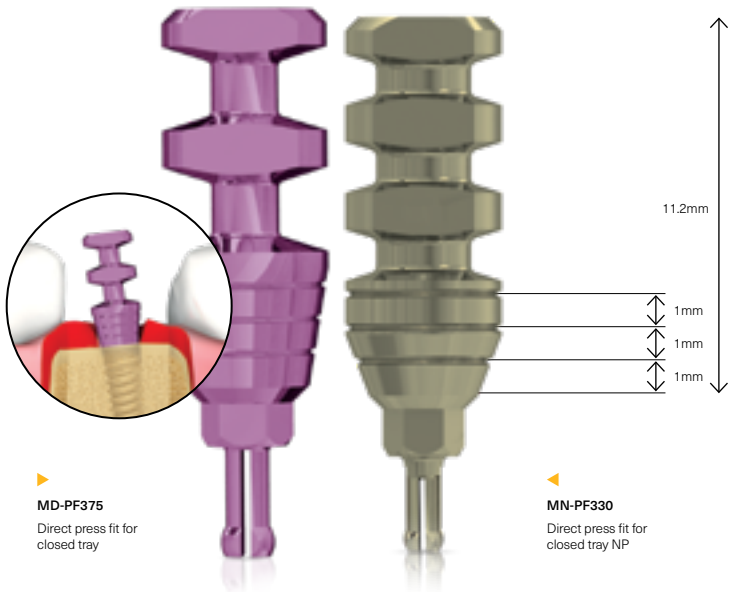

SURGICAL TOOLS

**IMPLANT
EXTRACTION KEY**

The implant extraction key is designed for the extraction of mountless standard or wide platform implants, and can be used manually or with a ratchet.

The key consists of two components: the body, which includes a standard hex. and a key screw, that passes through the body to allow a firm connection between implant and key; for a safe and simple implant extraction. It is recommended to dismantle both components (key body and screw), prior to cleaning and sterilization.

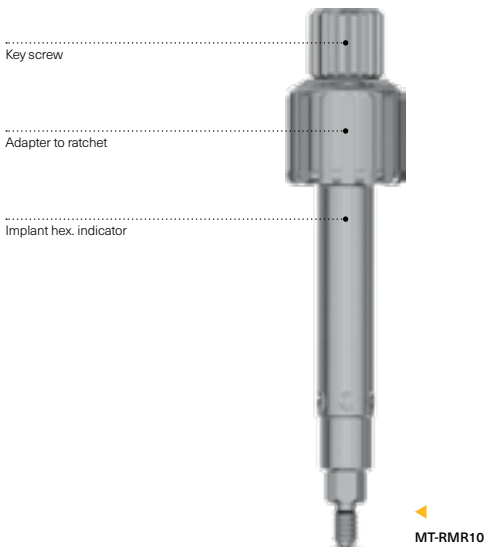

MT-RMR10

Direct Hand and Ratchet Hex. Key

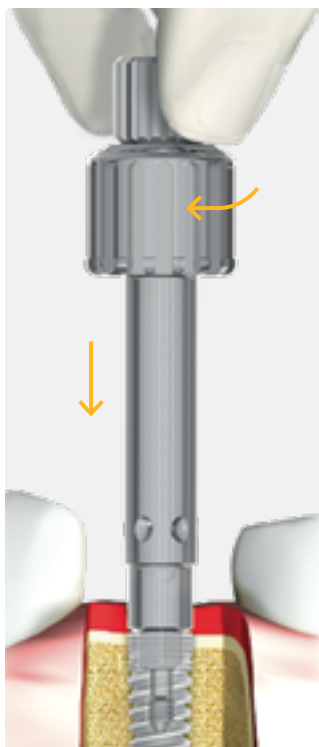

① **By Hand**

Tightening the screw to the implant

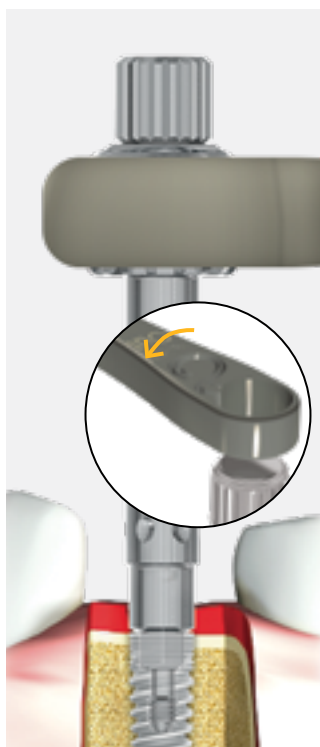

② **By Ratchet**

Ratchet is connected to top of the key in order to extract the implant.

SURGICAL TOOLS
**SPECIALIZED
SURGICAL TOOLS**

SEVEN® Insertion Tools

Insertion tools are available in short and long versions, for manual, ratchet or motor options.

Manual and ratchet tools

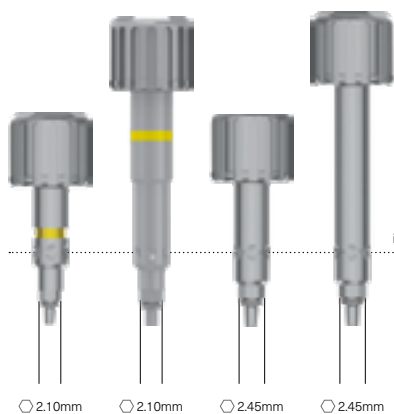

Motor connection

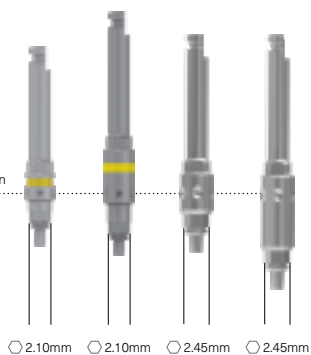

①

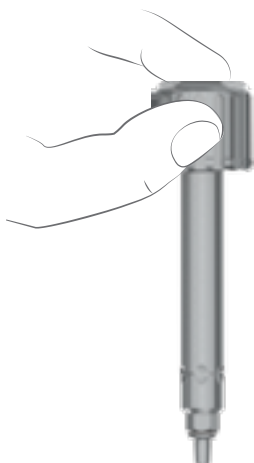

②

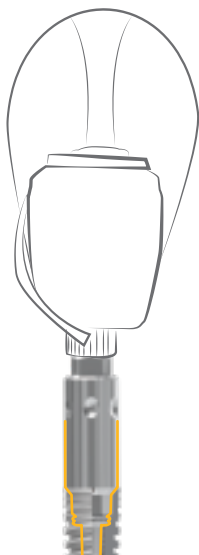

③

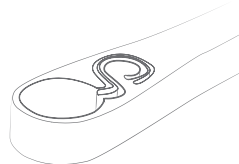

Insertion Options

- ① Insertion tool and hand key adapter
- ② Insertion tool for motor
- ③ Insertion tool in ratchet adapter



SS

PROSTHETIC TOOLS

FRICITION FIT EXTRACTOR

MT-RE172/ MT-RE160

The friction fit extractors are designed to separate the friction fit abutments from the implant. The extractors are color-coded, purple for standard/wide abutments and yellow for narrow abutments.



▶ **MT-RE172**
Int. connection
abutment extractor
Standard / Wide

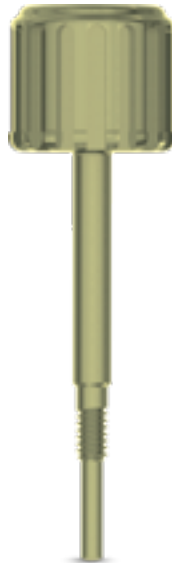

◀ **MT-RE160**
Int. connection
abutment extractor,
Narrow

Mode of Action

The extractor key applies vertical load parallel to the long axis of the implant. Thus, it can release a "locked" abutment from an implant.

For Narrow Implants

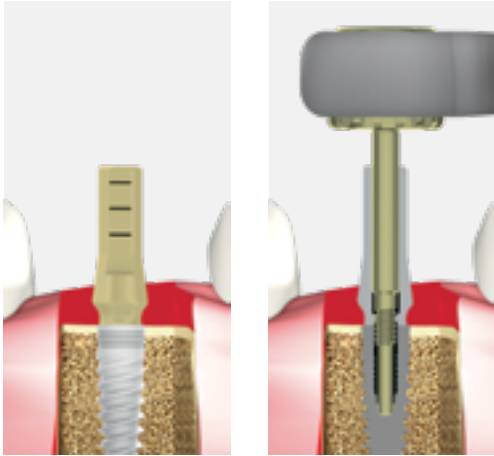

For Standard / Wide Implants

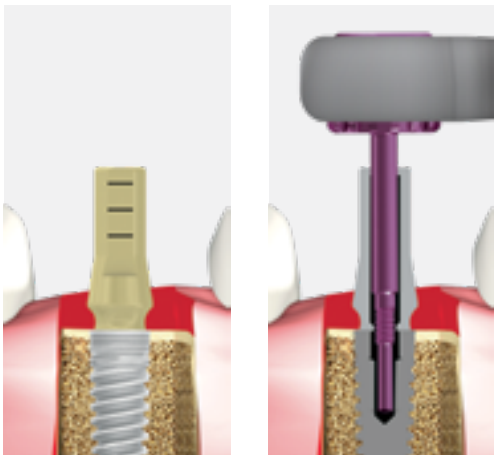

SS

PROSTHETIC TOOLS

SOS BROKEN SCREW KIT

MT-TF172 / MT-RT001/ MT-HW001/ MT-TF160/ MT-RT002

The SOS broken screw kit was designed to facilitate the removal of a broken screw from within an implant.

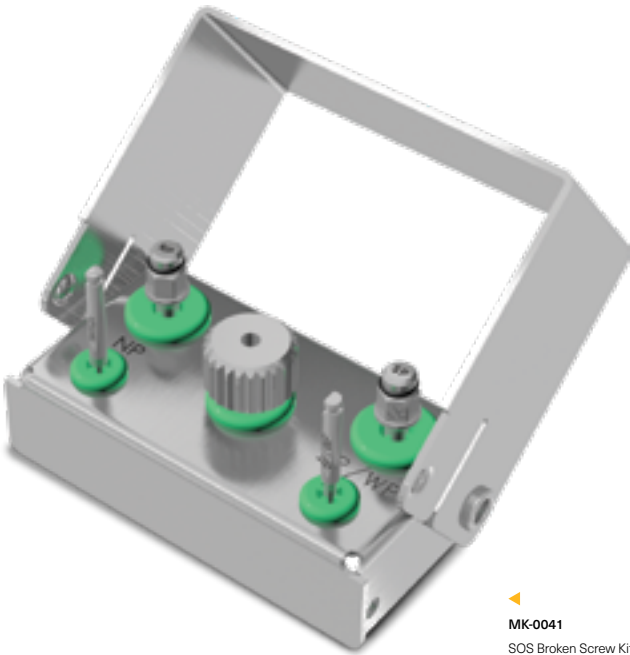

MK-0041

SOS Broken Screw Kit

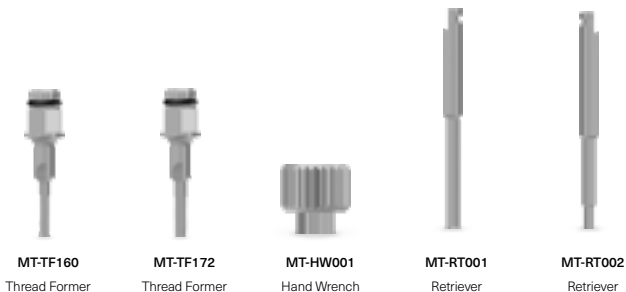

Instructions for use

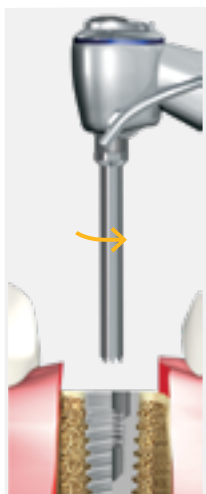

①

- Connect the retriever to a micromotor.
- Adjust the micromotor to low speed (15-25 RPM), max. torque and in reverse mode.

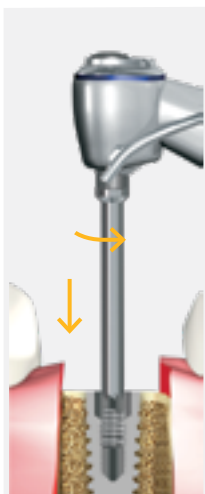

②

- Apply mild pressure with the retriever to the top of the broken screw.
- While maintaining pressure, activate the motor. This action should release the screw. If the screw is still not released, apply intermittent pressure on the screw.



③

- Use the thread former with care.
- Be sure to align the thread former parallel to the long axis of the implant.
- Always start by using a hand wrench. Apply gentle but firm force while turning the thread former in a clockwise direction. Release the pressure at the end of each complete turn by turning it 30° in a reverse direction, and repeat the action as needed.
- In instances where greater torque is needed, a ratchet may be used.

SURGICAL TOOLS MAINTENANCE

Pre-Cleaning

- Disassemble the device if required.
- Soak all instruments immediately after use in a detergent and disinfecting solution, preferably an enzymatic cleaning solution, with a pH level between 6-9, prepared with lukewarm water, for 5 minutes.
- Scrub the instruments under running water with soft nylon brush to remove any remaining blood or debris.
- Rinse under tap water (at least 1 min).
- Place the instruments in a kit, support or rack to avoid any contact between them during the next cleaning procedure.

Cleaning Procedure

Manual Cleaning

- Prepare an ultrasonic bath with a cleaning solution at a concentration and temperature specified in the detergent manufacturer's instructions.
- Immerse the instruments completely and activate the bath for at least the recommended time in the detergent manufacturer's instructions.
- Rinse under tap water (at least 1 min).

Alternative: Automated Cleaning

- Place the rack in a washer-disinfector and apply a cleaning procedure according to the manufacturer's instructions.

Drying and Sterilization

- Dry on a single-use non-woven cloth, through a drying cycle of washer-disinfector or with filtered compressed air.
- Inspect the devices and discard those with defects. Repeat cleaning if required.
- Assemble the device if required.
- Place the devices in a kit, and pack in sterilization pouch.
- Steam sterilize according to the table below. Do not exceed the recommended temperature specified.
- Keep inside the sterilization packaging in a dry and clean environment.

Cycle type	Pre-vacuum	Gravity displacement
Temperature	132°C/270°F	135°C/275°F
Exposure	4 min.	10 min.
Drying time	20 min.	30 min.



Recommendations

- Cutting tools should be used for a maximum of 30 uses.
- Distilled water should be used in order to prevent water spots.
- For all metal instruments, it is recommended to use anticorrosive disinfecting and cleaning agents. They should be aldehyde, ethanolamine, chlorine and acid free.
- Use only autoclaves that meet the requirements of EN 13060, EN 285.
- Use a validated sterilization procedure according to ISO 17665.
- For automated cleaning procedures, use a washer disinfector approved according to EN ISO 15883.

Attention: For your own safety, please wear personal protective equipment (gloves, glasses, mask).



PACKAGING

- 78 Implant Packaging
- 80 Implant Identification Codes
- 81 Implant Data Label
- 82 Implant Package Handling
- 88 Planning Transparency
- 89 Symbols

PACKAGING
**IMPLANT
PACKAGING**

The MIS packaging system is designed for simple and easy use.

All implant boxes feature distinctive colors, large typeface, clear data labels and a pull tab for quick opening. Box dimensions are designed for compact, space-saving storage.

Individual Implant Package

Following our "Make It Simple" philosophy, MIS is proud to be the first to include a sterile, single-use final drill with every SEVEN[®] implant, to ensure a safe and precise surgical procedure.

10 Implants Package

A convenient 10 implants package is available. The box is ideal for storage in drawers or cabinets for easy identification of implant type, diameter and length.



Double Container Sealing System

To ensure that implants are sterile, and to prevent surface contamination, each implant is stored in a titanium sleeve within an internal plastic tube. This tube is held in a larger sealed outer tube, marked with all relevant information. The inner tube is therefore sterile, and may be brought into the sterile surgical field whenever needed.



▲
Cover screw

▲
Implant



▲
Implants are packed without a mount, for ease of use and a faster placement procedure.

PACKAGING

**IMPLANT
IDENTIFICATION
CODES**

For easy identification of implant diameter, length and platform, the package and cap of each outer tube is coded as follows:



SS

PACKAGING
**IMPLANT
DATA LABEL**

Each package contains three data labels, which include all required information relevant to the implant. The following image illustrates the label and its contents:

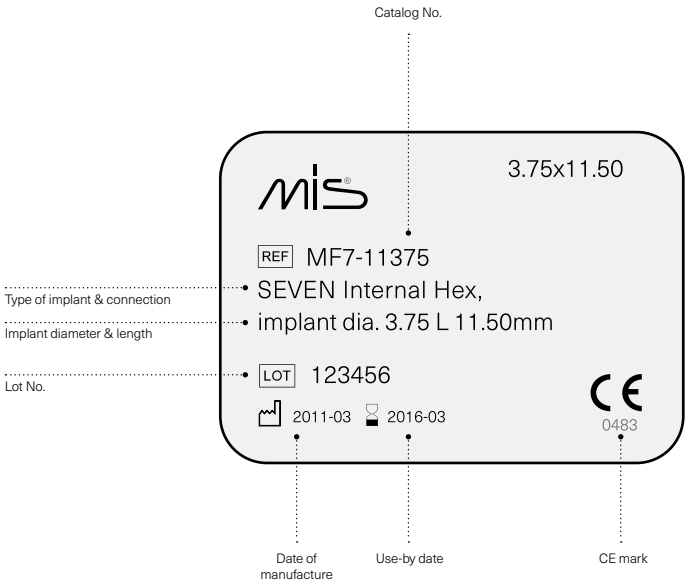

PACKAGING

**IMPLANT
PACKAGE HANDLING**

Both physical and visual inspection of the implant package is required prior to use.

This ensures that the correct implant model and dimensions are being used for the selected site.



①

Open the box by pressing on the marked dotted line, and remove the outer tube from the box.



②

Open the outer tube by turning the cap counter-clockwise. Drop the sterile inner tube into the sterile field.

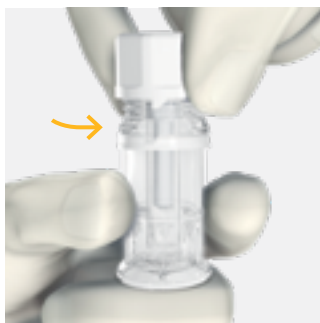

③

The implant is held by a titanium sleeve. To expose the implant, hold the tube with the titanium sleeve facing up. Rotate and pull to open the upper cap.

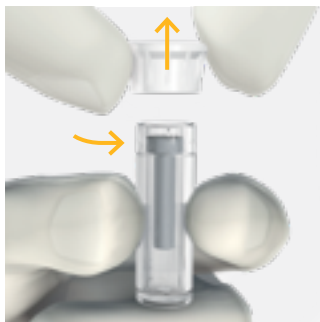

④

Use one of the following three options to remove the implant from the inner tube:

OPTION 1

Contra-angle hand piece

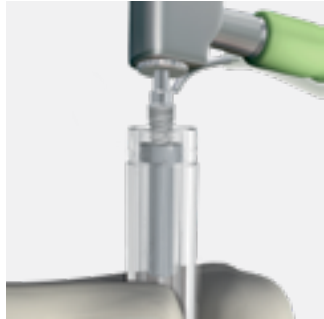

OPTION 2

Ratchet



OPTION 3

Implant extractor



⑤

Remove the cover screw from the inner tube cap using the key.

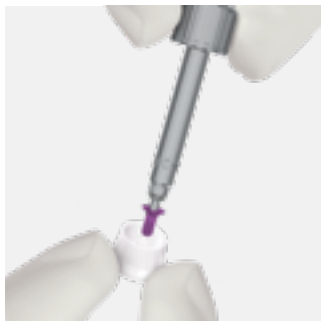

⑥

Begin tightening the screw.

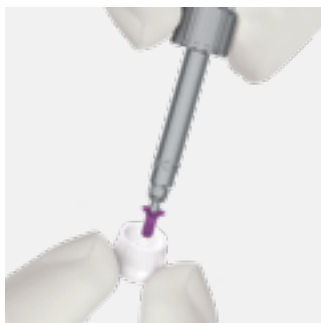

⑦

The data labels should be placed in the medical chart.



SS

PACKAGING

**IMPLANT
PACKAGE HANDLING**



Cover Screw



Implant



Final Drill



Inner Tube



Outer Tube

PACKAGING SYMBOLS

Key to symbols that appear on labels and instruction leaflets:



Do not re-use



Date of manufacture



Sterilized using gamma irradiation



Manufacturer



Do not re-sterilize



Batch code



Caution, consult
accompanying documents



Catalog number



Use-by date



Keep away from sunlight



Do not use if package is damaged

Rx only

Caution: U.S. federal law restricts this device for sale by or on the order of a dental professional





<http://www.mis-implants.com>

MP-UJ048 Rev9 11/2019